

Technische Daten: Art.-Nr.: 228 290

Wandaußenmaß: 290 x 220 cm

Bohlenstärke: 28 mm



Kontrolliert durch:

Achtung: Alle angegebenen Maße sind ca.-Maße!

3D-Darstellung Art.-Nr. 228 290

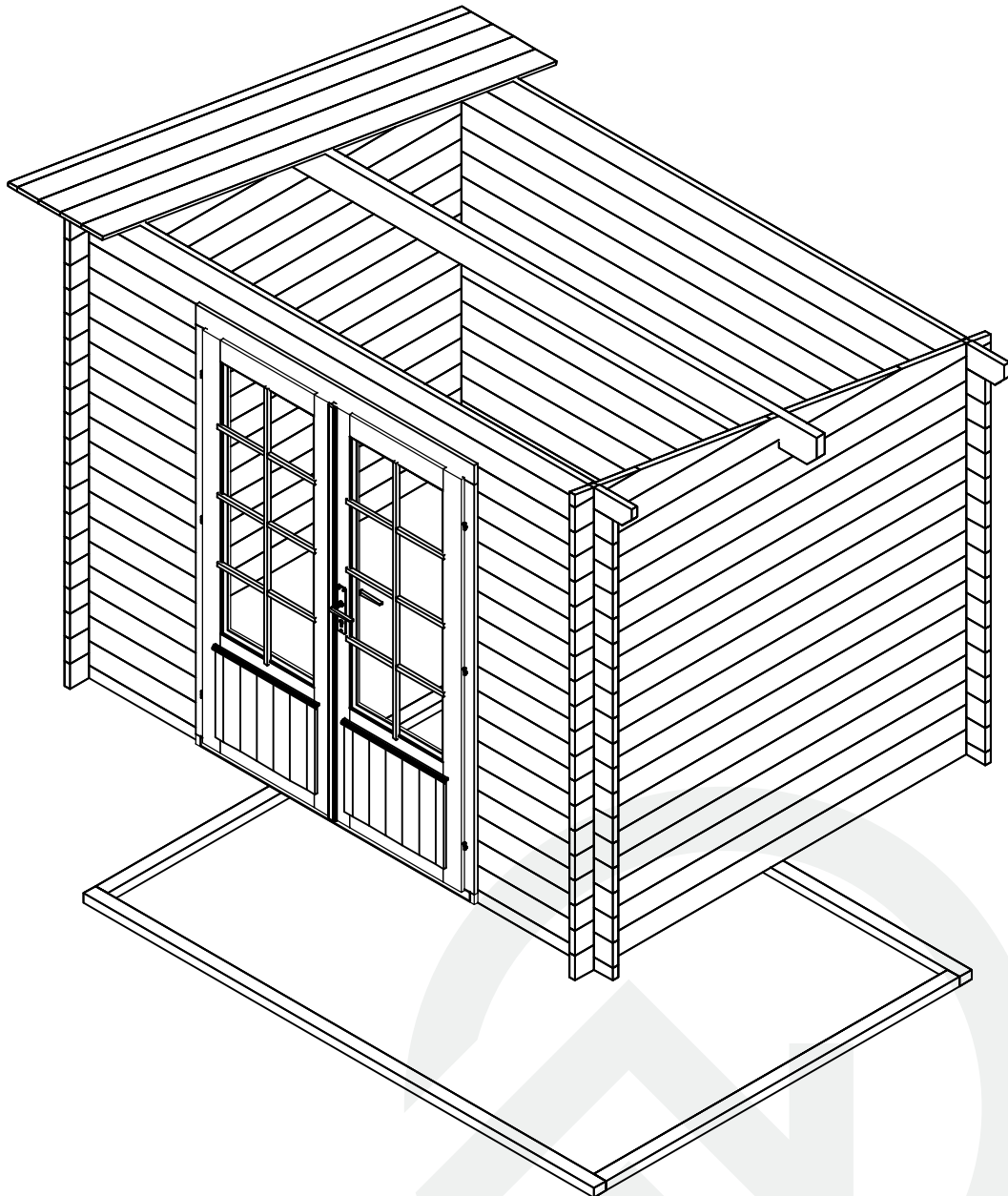

Grundriss

Art.-Nr. 228 290

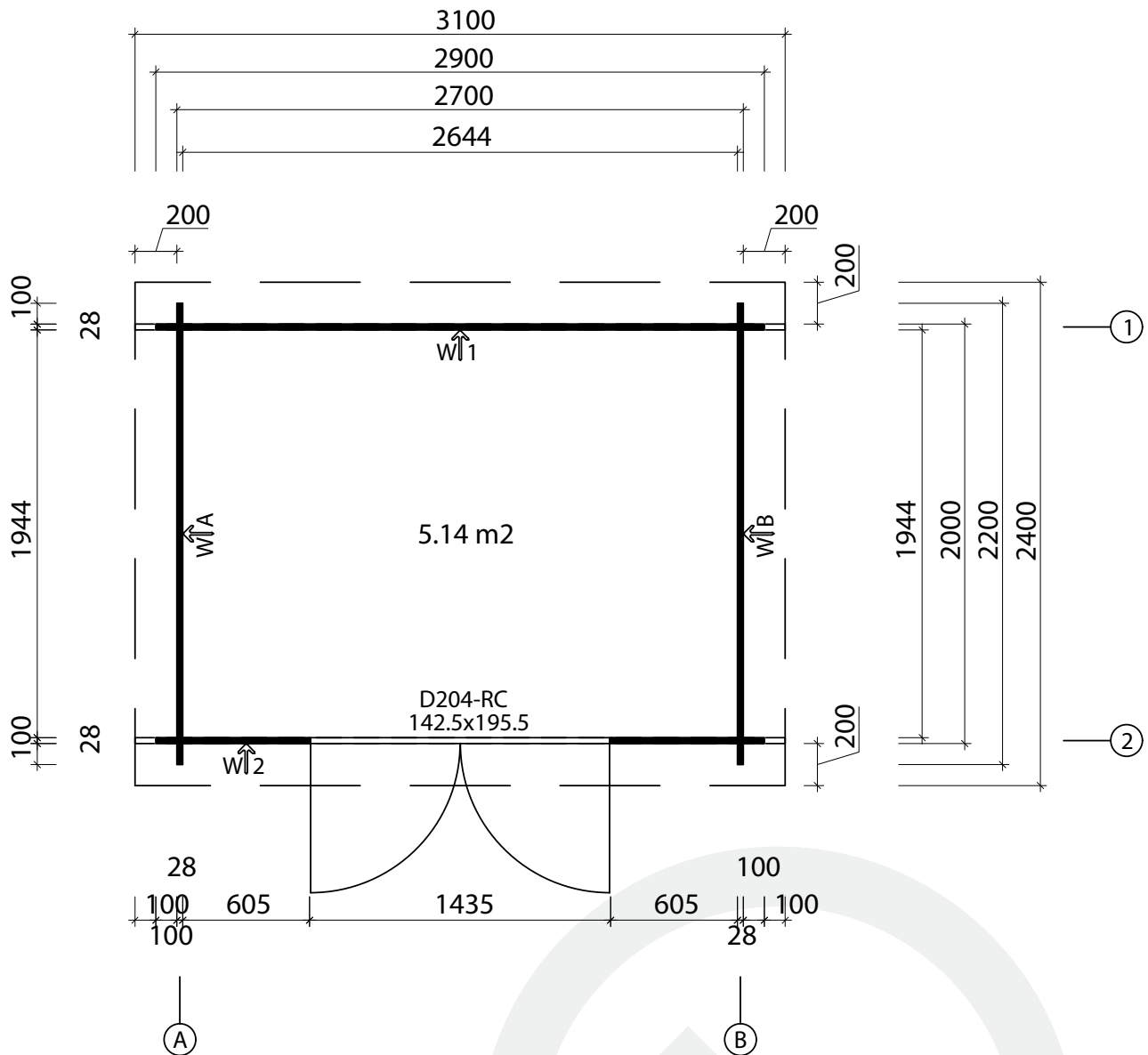

Q2-Qualitätsklasse für Fenster und Türen/

* Fenster und Türen sind mit Sprossen

Lagerholzplan und Fundamentplan Art.-Nr. 228 290

Wir empfehlen als Fundament für Ihr Gartenhaus eine vollflächig festgegründete, gepflasterte oder betonierte Fläche.
Wahlweise ist auch ein Punkt- oder Streifenfundament möglich.

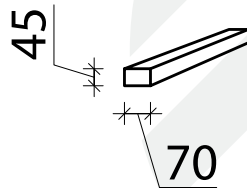
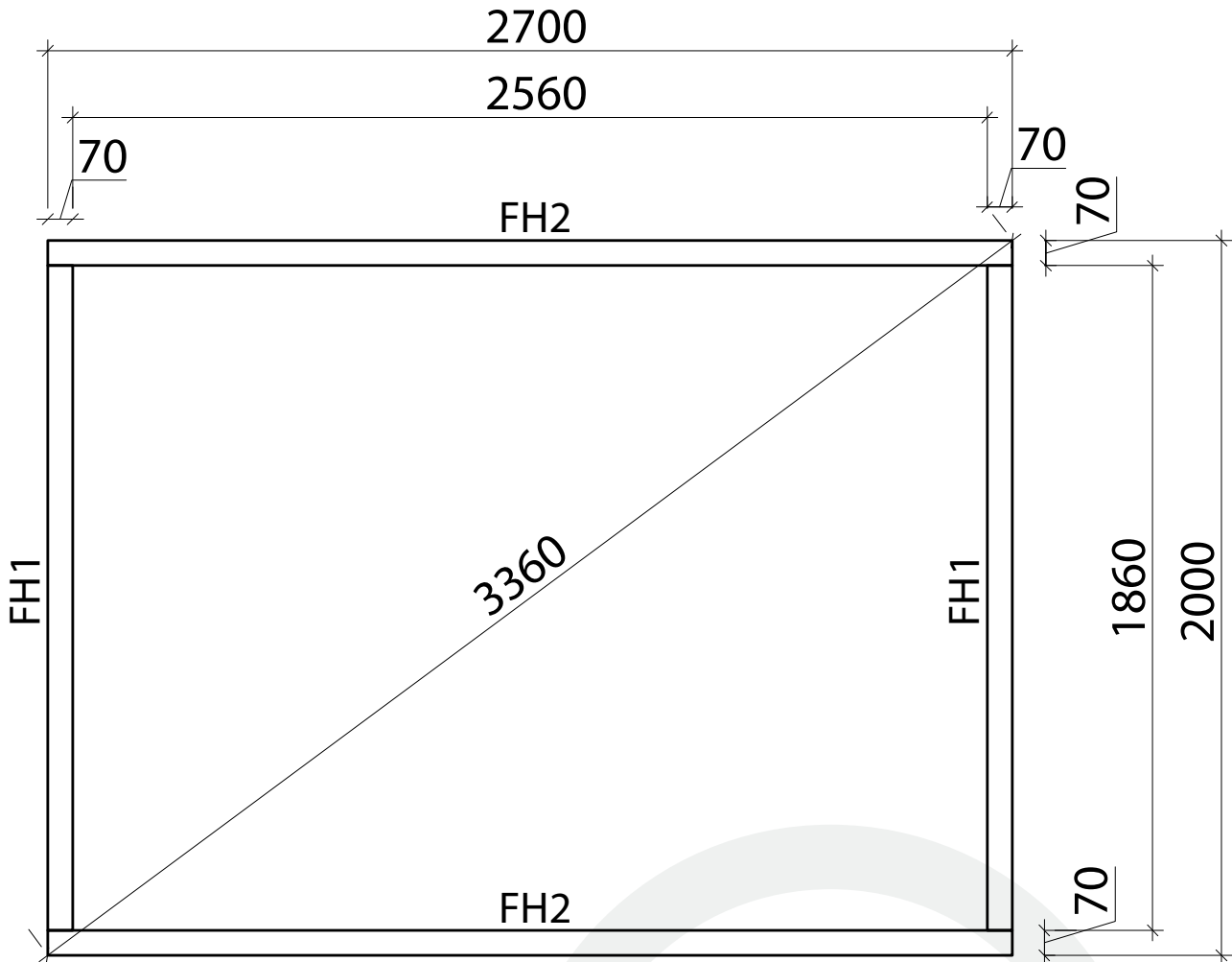



Teileliste 1

Art.-Nr. 228 290

Pos		Stck	Profil (mm)	Länge (mm)
001		1	28x114	3100
002		1	28x97	3100
003		16	28x114	2900
004		1	28x57	2900
006		32	28x114	2200
009		34	28x114	733
010		2	28x57	733
WA-1		1		
WB-1		1		
FH2		2	70x45	2700
FH1		2	70x45	1860
PF1		1	44x145	3100
	DACHBRETTER	28+1	113x16	2430
G02-1	GIEBELBRETT 18x120	2	18x120	2450
G05-1	GIEBELDECKLEISTEN 18x40	2	18x40	2430
T02-1	TRAUFBRETT 18x120	1	18x120	3136
T01-1	TRAUFBRETT 18x90	1	18x90	3100
T04-1	TRAUFENDECKLEISTEN 18x40	1	18x40	3136
T06-1	TRAUFENLEISTEN 18x40		18x40	7,0 lfdm
SM-1	Sturmleisten	2	18x40	1770
SM-2	Sturmleisten	2	18x40	2110
SH	Schlaghölzer	3		
SS03	Schloßschrauben M8x60 Mutter M8 U-Scheibe Ø25 - Befestigung für Sturmleisten	12		

Teileliste 2

Artikel-Nr.: 228 290

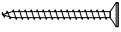
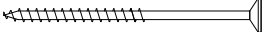
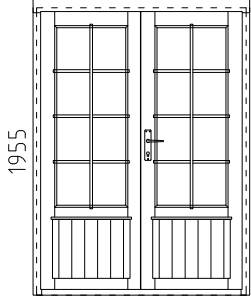
Pos				Stck	Profil (mm)	Länge (mm)
NG04	NÄGEL 2.5x50	Dachbretter		168		
SR32	SCHRAUBEN 3.0x30	Traufenleiste 40x18		14		
SR37	SCHRAUBEN 3.5x45	Giebeldeckleisten, Giebelbretter Traufenbretter, Traufendeckleisten		45		
SR57	SCHRAUBEN 5.0x100	Fundamenthölzer		16		
	<p>Q2 TÜR 1425x1955</p> <p style="text-align: center;">1425</p>  <p style="text-align: center;">1955</p> <p style="text-align: right;">TU7-GH / D204-RC</p> <p style="text-align: right;">DIN rechts</p>	D2-D28R-78C-14251955		1		
	✓ - bitte selber anpassen (falls nötig)!					

Wandplan 1

Art.-Nr. 228 290

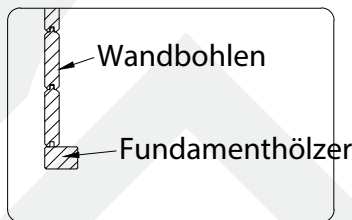
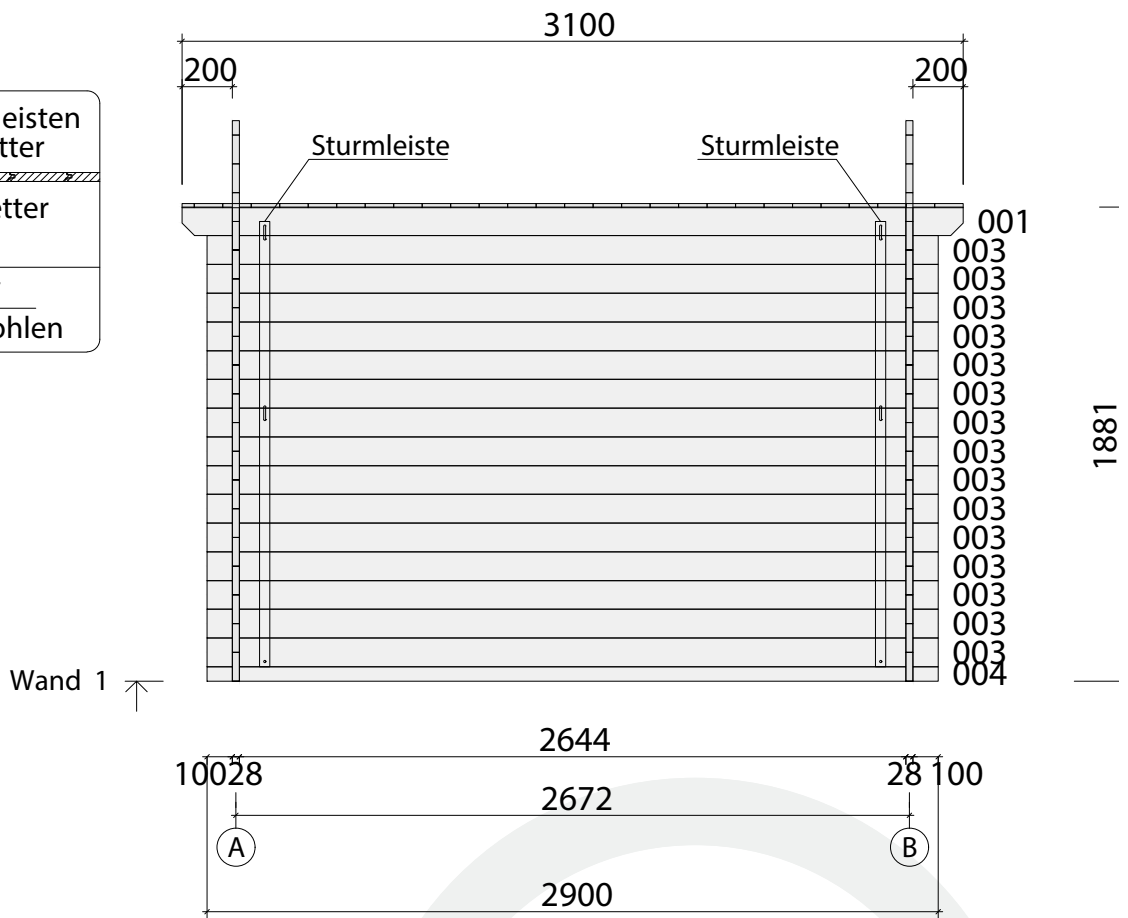
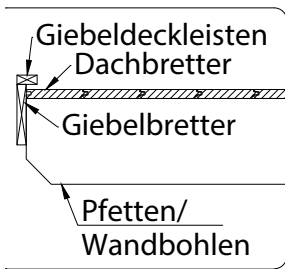

Wandplan 2

Art.-Nr. 228 290

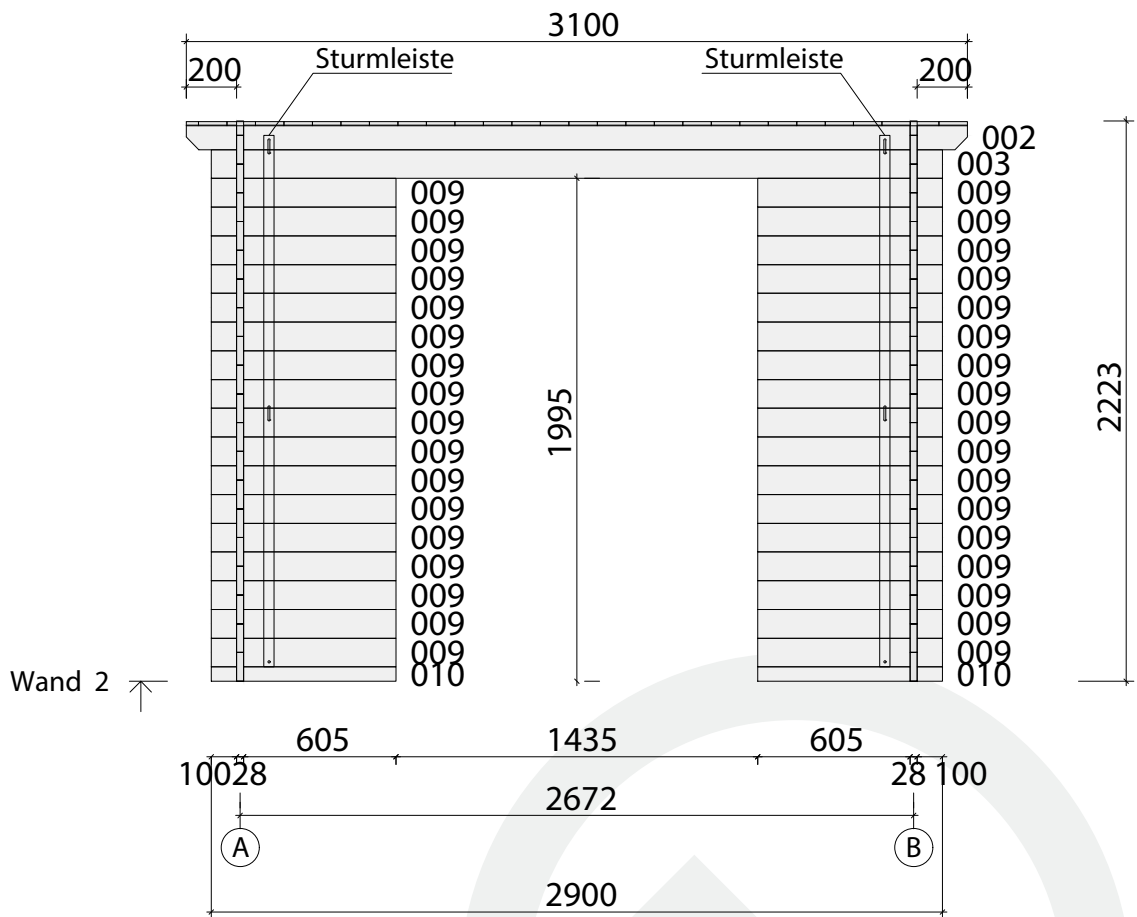

Wandplan B

Art.-Nr. 228 290

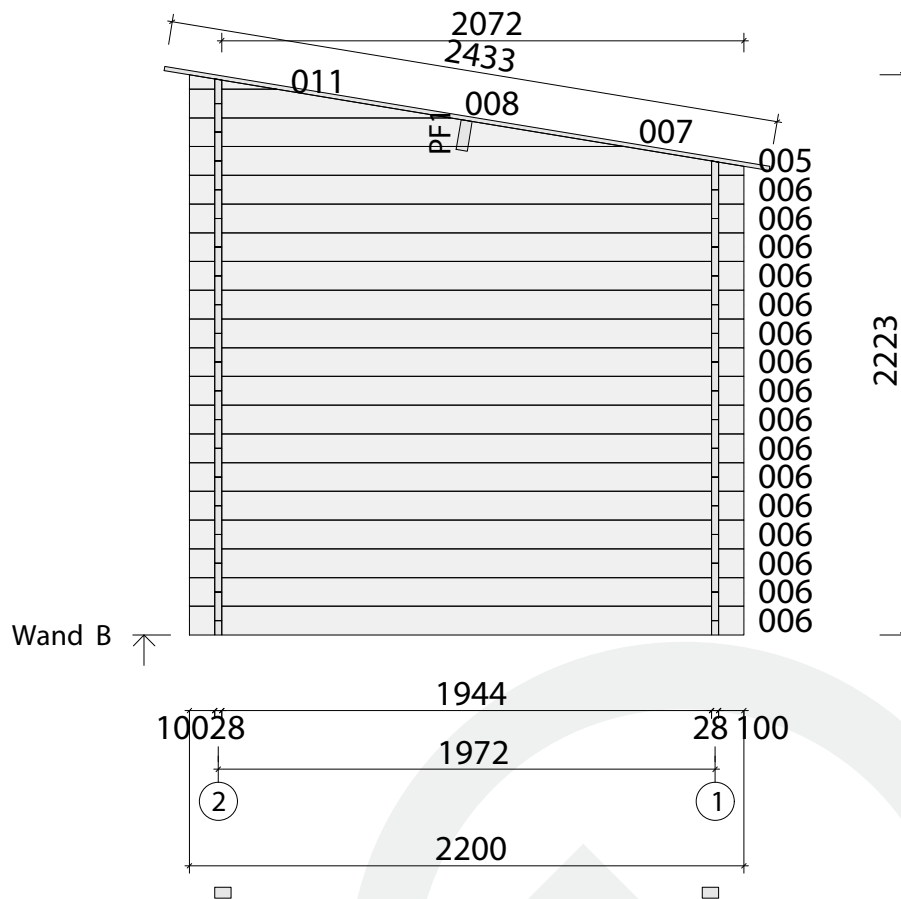

Türmontage

Art.-Nr. 228 290

Uks Q2-Q3 - koostamisjuhised
 Door Q2-Q3 - assembly instructions
 Tür Q2-Q3 - Montageanleitung

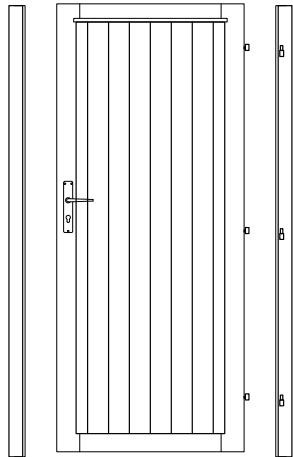
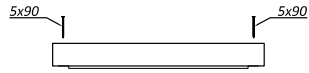

*Kui ühepoolne uks ei ole kokku pandud!
 *When single door is not assembled!
 *Wenn Einzeltür ist nicht zusammengebaut!

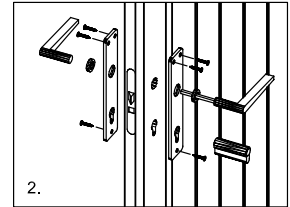
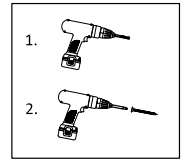
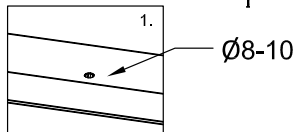
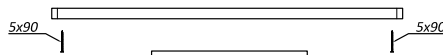
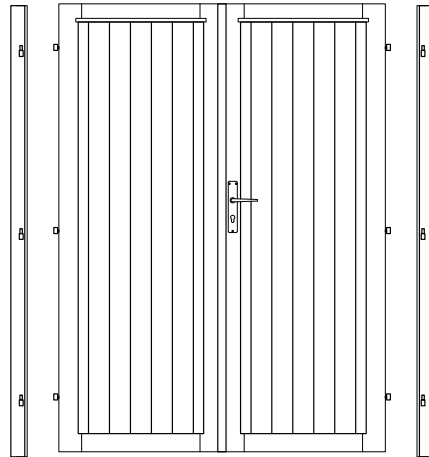
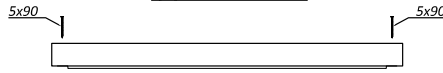
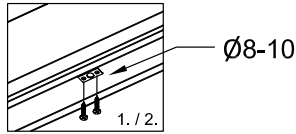

*Kui hinged ei ole paigaldatud!
 *When hinges are not attached!
 *Wenn Scharniere sind nicht angebracht!

