

Technische Daten: Art.-Nr.: 228 330,

831 331, 831 332, 831 333, 831 334

Wandaußenmaß: 300 x 300 cm | Bohlenstärke: 28 mm



**FARB-  
BEHANDLUNG**

Fichte

Bernstein

Gletschergrau

Felsgrau

Kontrolliert durch:

Achtung: Alle angegebenen Maße sind ca.-Maße!

# 3D-Darstellung

## Art.-Nr. 228 330, 830 331, 830 332, 830 333, 830 334

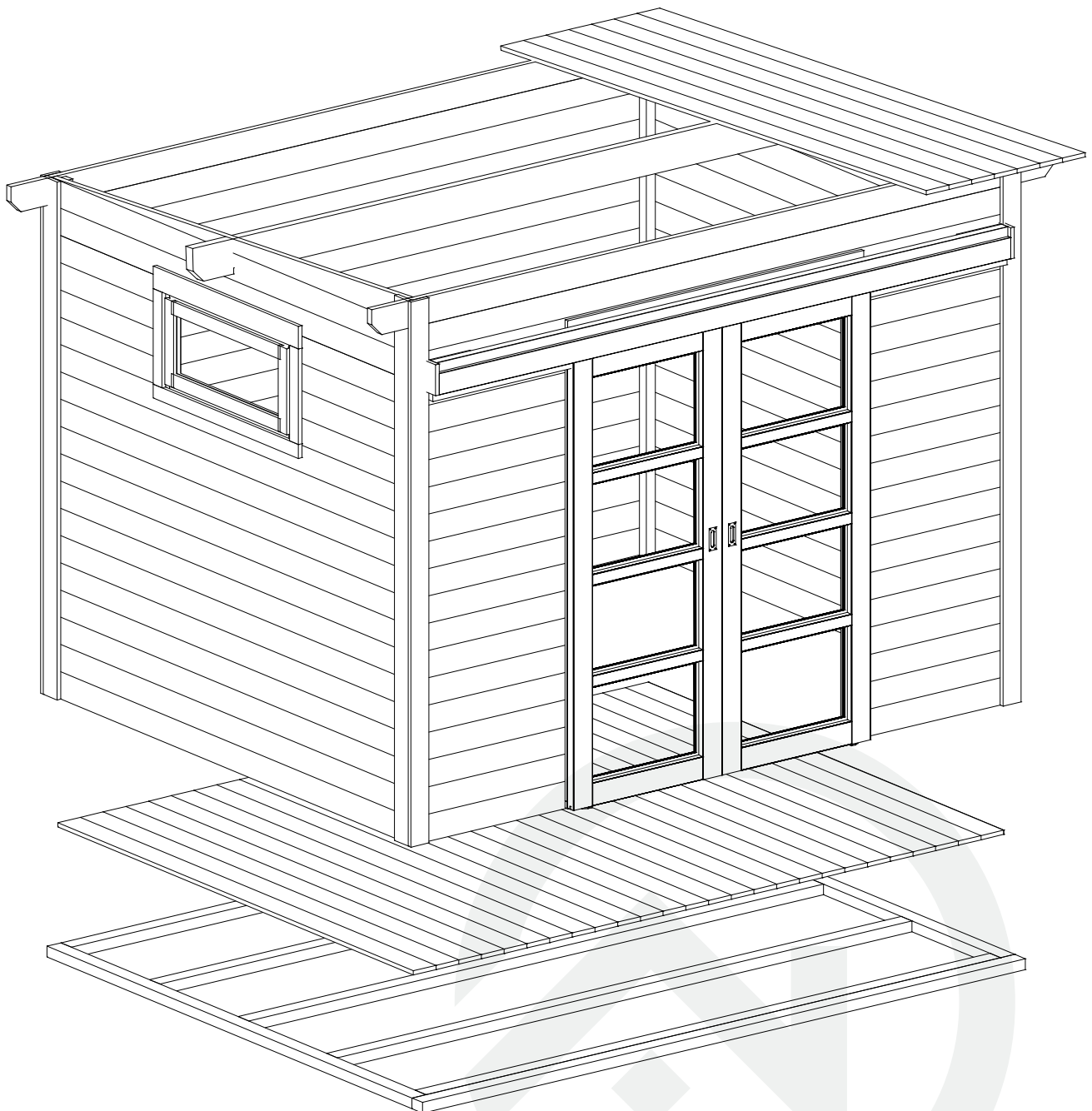

# Grundriss

Art.-Nr. 228 330, 830 331, 830 332, 830 333, 830 334

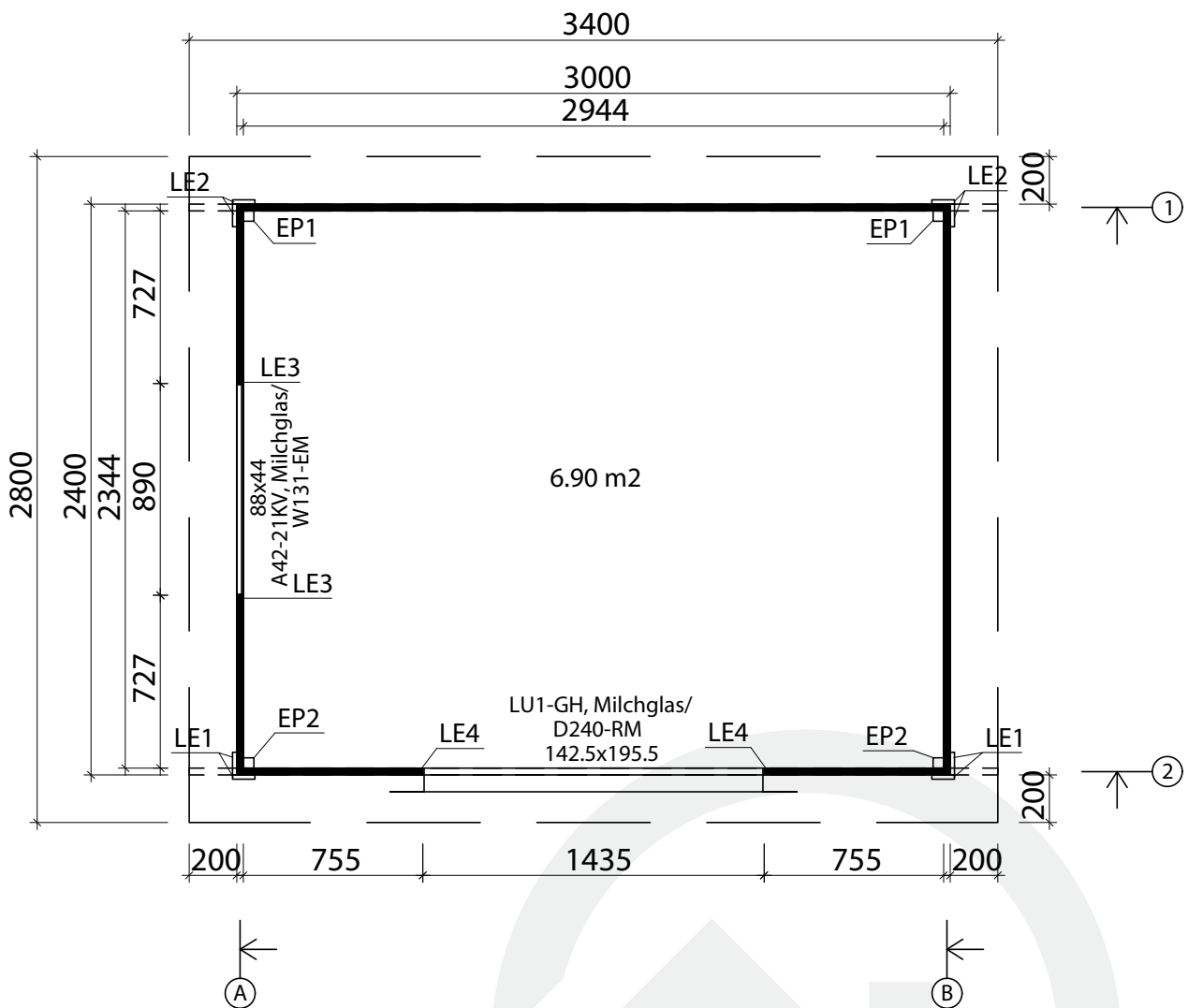

**Q2**-Qualitätsklasse für Fenster und Türen

\* Fenster und Türen sind ohne Sprossen

# Lagerholzplan und Fundamentplan Art.-Nr. 228 330, 830 331, 830 332, 830 333, 830 334

Wir empfehlen als Fundament für Ihr Gartenhaus eine vollflächig festgegründete, gepflasterte oder betonierte Fläche.  
Wahlweise ist auch ein Punkt- oder Streifenfundament möglich.

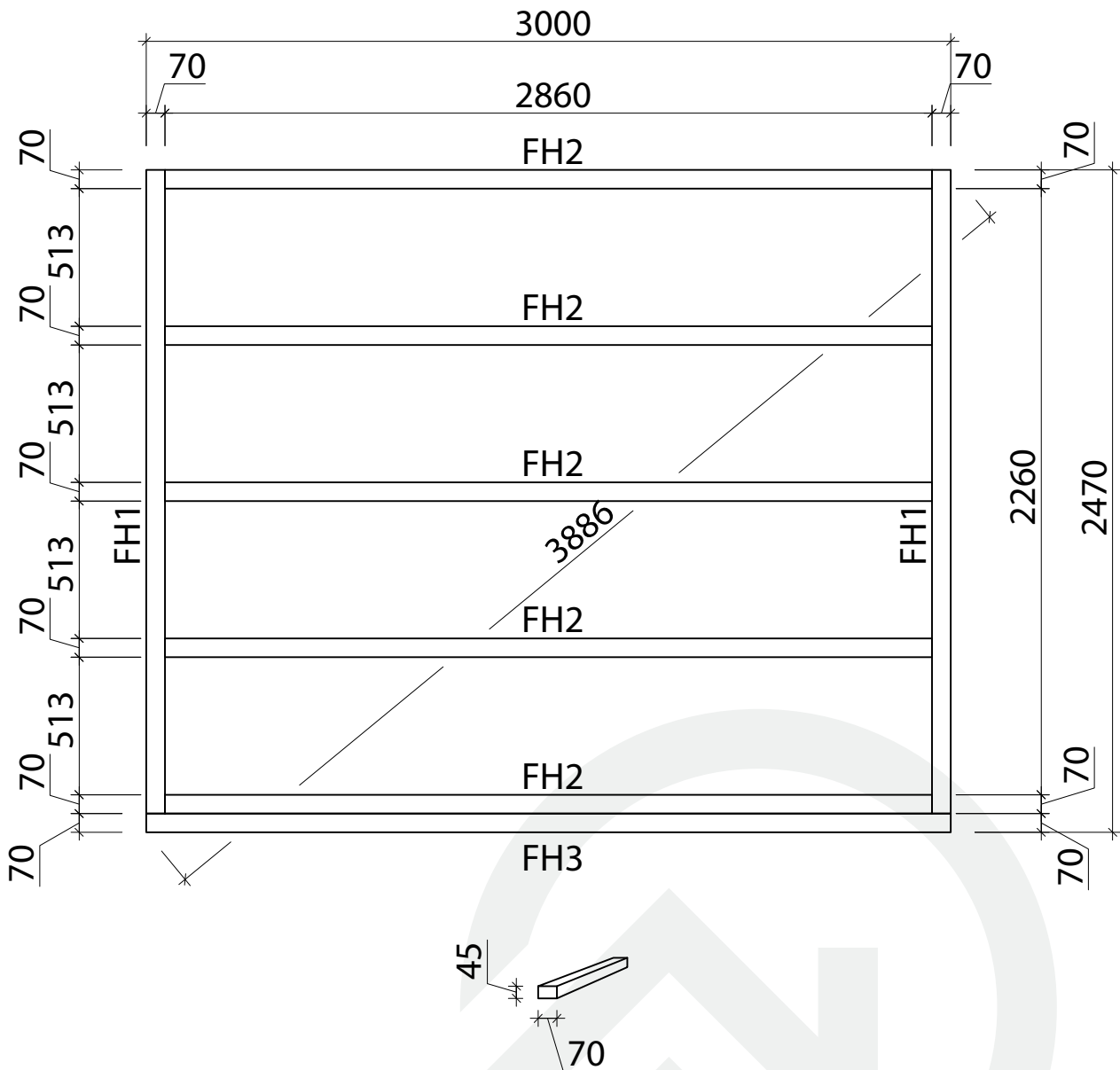













# Teilleiste 1

## Art.-Nr. 228 330, 830 331, 830 332, 830 333, 830 334

Pos		Stck.	Profil (mm)	Länge (mm)
001		2	28x114	3400
002		1	28x114	3000
003		19	28x114	3000
005		31	28x114	2344
006		1	28x114	2344
007		34	28x114	768
008		8	28x114	712
WA-1		1		
WB-1		1		
FH3	FUNDAMENTHÖLZER (imprägniert) 	1	70x45	3000
FH2	FUNDAMENTHÖLZER (imprägniert) 	5	70x45	2860
FH1	FUNDAMENTHÖLZER (imprägniert) 	2	70x45	2400
LE1	LEISTE 	4	95x18	2280
LE2	LEISTE 	4	95x18	2166
LE4	LEISTE 	2	15x28	1938
LE3	LEISTE 	2	15x28	446
EP2	ECKPFOSTEN 	2	44x44	2270
EP1	ECKPFOSTEN 	2	44x44	2156
PF1	PFETTEN 	1	44x145	3400
	DACHBRETTER	31+1	113x18	2800
	FUSSBODENBRETTER	27+1	113x18	2340
	FUSSBODENLEISTEN		18x40	11,0 lfm
G02-1	GIEBELBRETTER 18x120	2	18x120	2820
G05-1	GIEBELDECKLEISTEN 18x40	2	18x40	2820
T02-1	TRAUFENBRETTER 18x120	1	18x120	3436

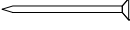
# Teileliste 2

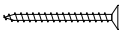
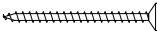
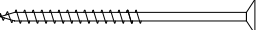
## Art.-Nr. 228 330, 830 331, 830 332, 830 333, 830 334

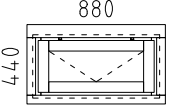
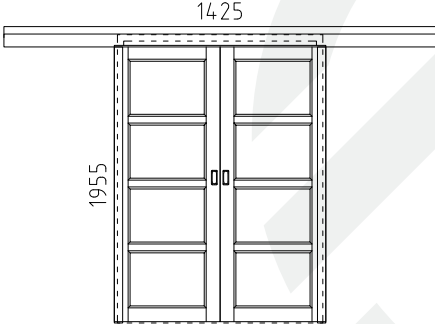
Pos		Stck.	Profil (mm)	Länge (mm)
T01-1	TRAUFENBRETTER 18x95 	1	18x95	3400
T04-1	TRAUFENDECKLEISTEN 18x40 	1	18x40	3436
T06-1	TRAUFENLEISTEN 18x40  ✓		18x40	7,0 lfm
LU- KL-1	LU - Blendleiste 18x95 	1	18x95	3000
LU- OK-1	LU - Endkappen 18x80 	2	18x80	130
LU- KT-1	LU - obere Rahmenteil 44x65 	1	44x65	3000
KP-1	DACHPAPPE  ✓		3,4m-4st.	14,0 lfm
NG01	DACHPAPPNÄGEL 2.8x15 	200		
NG04	NÄGEL 2.5x50 Dachbretter Fussbodenbretter 	456		
SR32	SCHRAUBEN 3.0x30 Fussbodenleiste Traufenleiste, Giebelleiste 40x18 	38		
SR37	SCHRAUBEN 3.5x45 Giebelbretter, Traufenbretter LE1, LE2, LE3, LE4 	194		
SR44	SCHRAUBEN 4.0x60 Wandbohlen zu Eckpfosten 	312		
SR57	SCHRAUBEN 5.0x100 Fundamenthölzer 	32		
SH	Schlaghölzer 	3		
	FENSTER <u>Q2</u> <span style="float: right;">W2-S28E-OXM-08800440</span>	1		
	 A42-21KV/W131-EM Milchglas			
	TÜR <u>Q2</u> <span style="float: right;">D2-Q28R-LLM-14251955</span>	1		
	 LU1-GH/D240-RM Milchglas			
	✓ - bitte selber anpassen (falls nötig!)			

# Wandplan 1

## Art.-Nr. 228 330, 830 331, 830 332, 830 333, 830 334

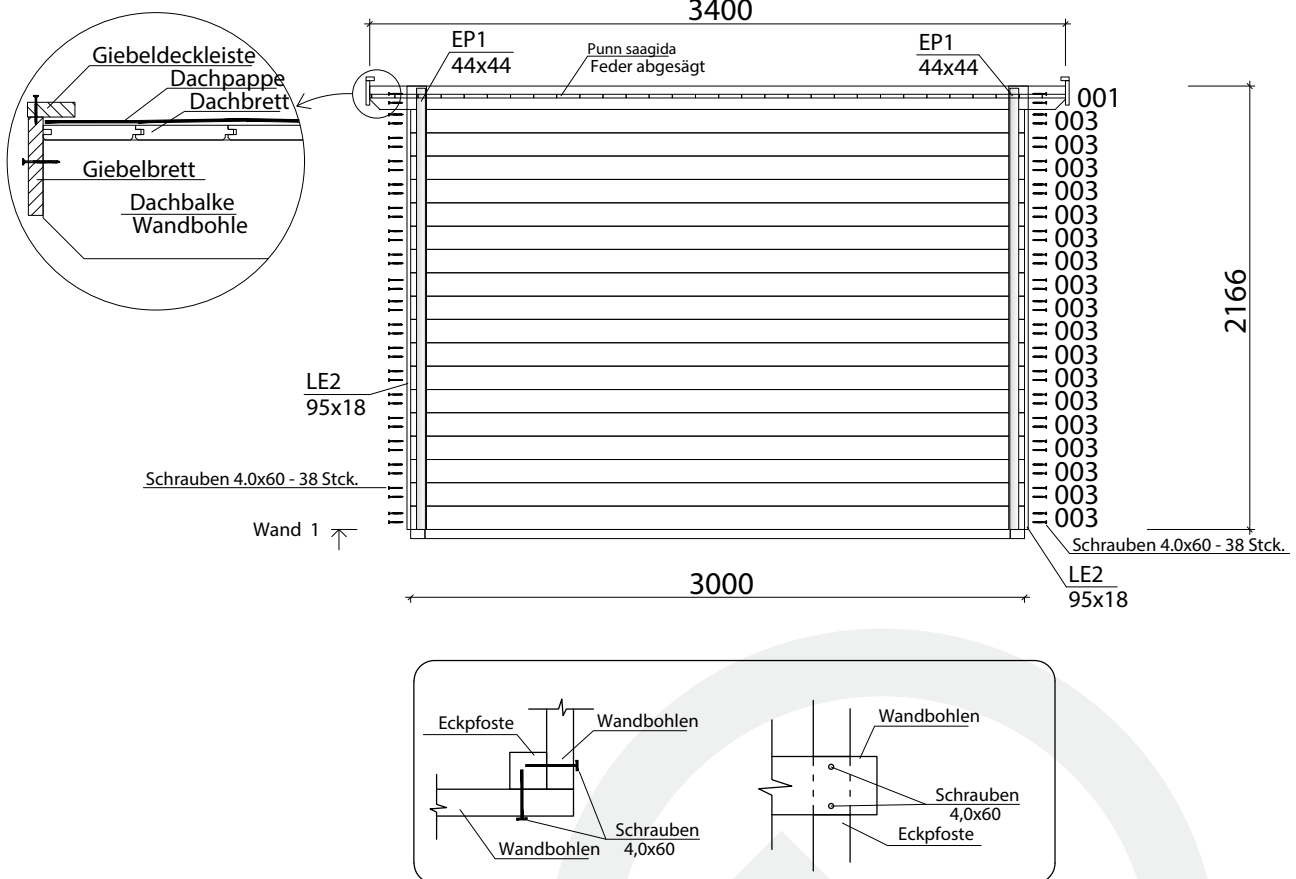









# Türmontage

## Art.-Nr. 228 330, 830 331, 830 332, 830 333, 830 334

