

Technische Daten: Art.-Nr.: 240570

Wandaußenmaß: 360 x 360 cm

Bohlenstärke: 44 mm



Vom Kunden farblich behandelt.

Kontrolliert durch:

Achtung: Alle angegebenen Maße sind ca.-Maße!

3D-Darstellung 240570

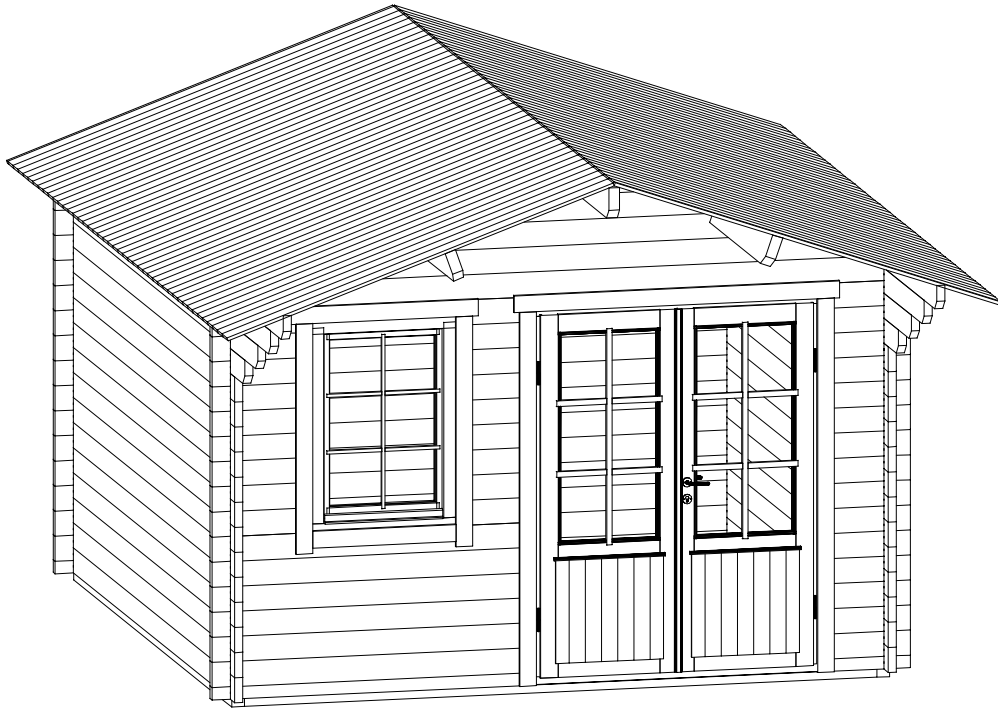

Grundriss 240570

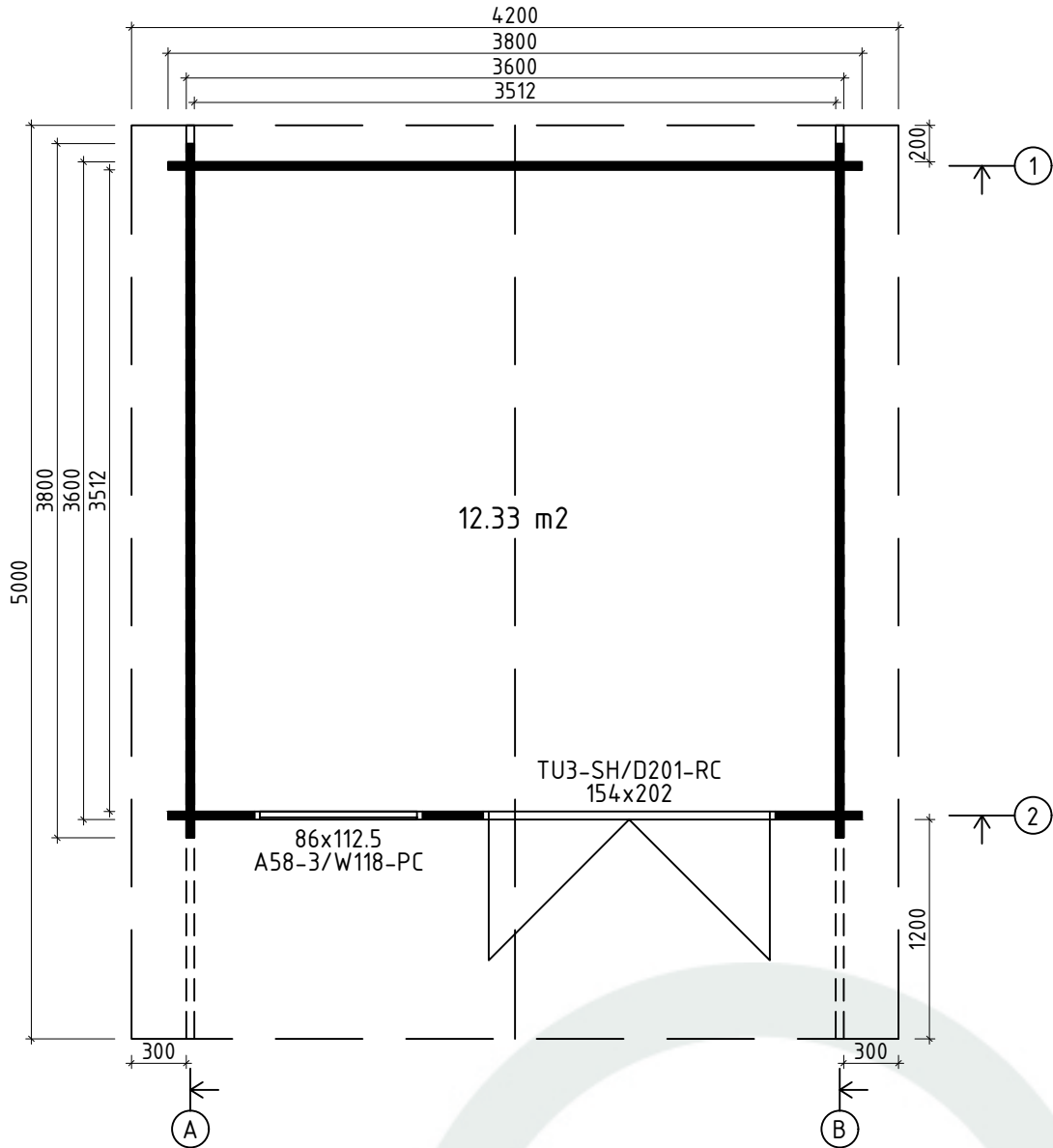

Lagerholzplan und Fundamentplan 240570

Wir empfehlen als Fundament für Ihr Gartenhaus eine vollflächig,
festgegründete gepflasterte oder betonierte Fläche.
Wahlweise ist auch ein Punkt- oder Streifenfundament möglich.

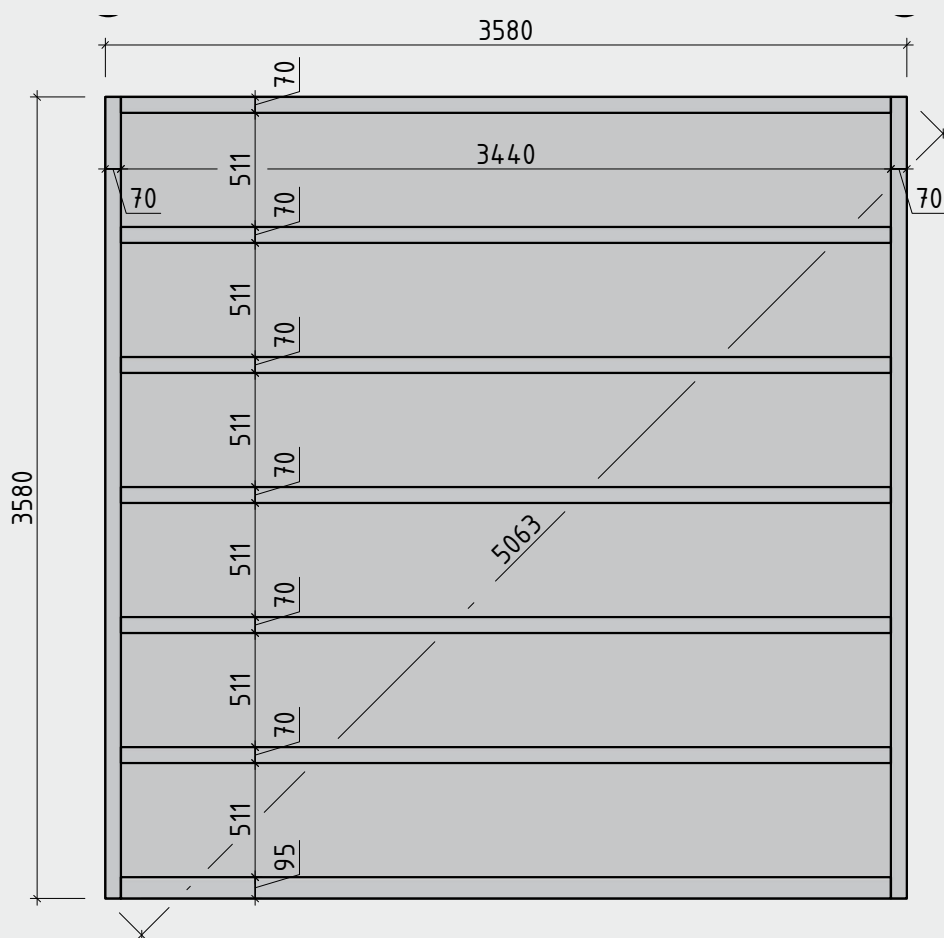









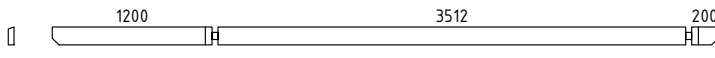
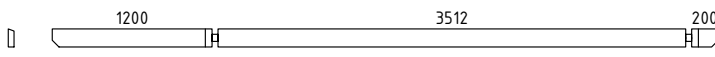

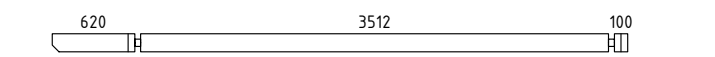
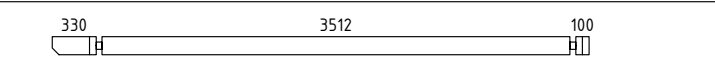

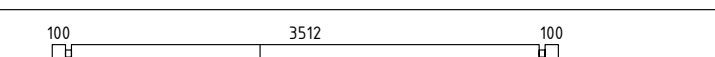
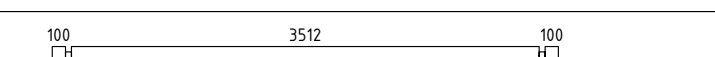
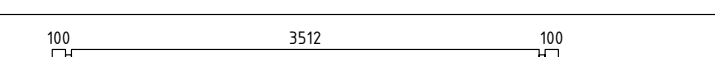
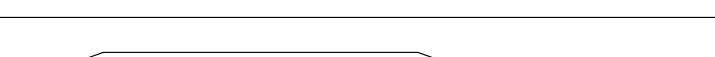
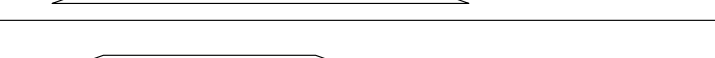
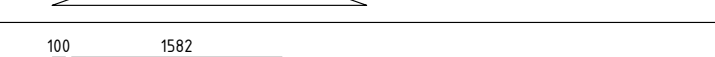
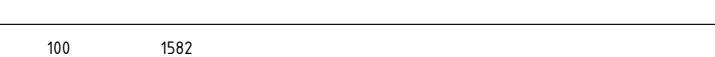
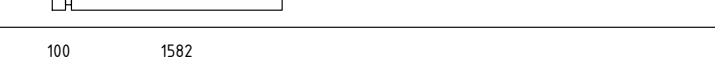
Q4 – Qualitätsklasse für Fenster und Türen







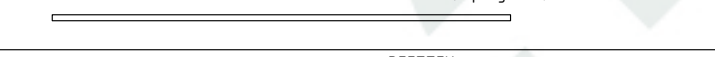
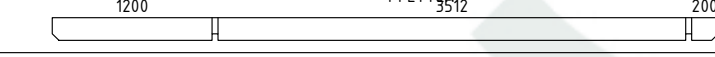





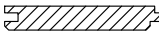





Teileliste 1

240570

Pos		Stck	Profil (mm)	Länge (mm)
001		1	44x135	5000
002		1	44x135	5000
003		2	44x135	4610
004		2	44x135	4320
005		2	44x135	4030
006		2	44x135	3800
007		26	44x135	3800
008		1	44x135	3800
009		16	44x135	3800
010		1	44x68	3800
011		2	44x135	3128
012		2	44x135	2361
013		1	44x68	1726
014		5	44x135	1726
015		1	44x135	1726
016		2	44x135	1593
017		1	44x68	474
018		24	44x135	474
019		4	44x135	389
020		9	44x135	332
FH3	FUNDAMENTHÖLZER (imprägniert) 	1	95x45	3440
FH1	FUNDAMENTHÖLZER (imprägniert) 	2	70x45	3580
FH2	FUNDAMENTHÖLZER (imprägniert) 	6	70x45	3440
PF1	PFETTEN 	3	58x170	5000
	DACHBRETTEN 	90+1	113x18	2226

Teileliste 2

240570

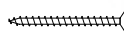
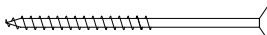
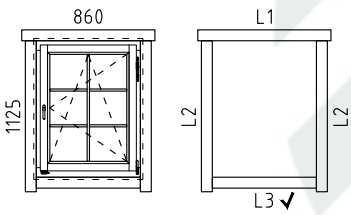
Pos		Stck	Profil (mm)	Länge (mm)
	FUSSBODENBRETTER 	32+1	113x18	3507
	FUSSBODENLEISTEN  ✓		18x40	15,0 lfm
G02-1	GIEBELBRETTER 18x120 19,4°  ✓	4	18x120	2306
G06-1	GIEBELDECKLEISTEN 18x58  ✓	4	18x58	2306
T01-1	TRAUFENBRETTER 18x95 	2	18x95	5000
T06-1	TRAUFENLEISTEN 18x40  ✓		18x40	10,0 lfm
GS	Giebelsegment 	2		
SH	Schlaghölzer 	3		
ML1	Metallstange 	1	D10	14.40
KL1	Gewindestange M8 	4	M8	2000
KL2	Gewindestange M8 	4	M8	325
KV M UT M8	Mutter M8 	8	M8	
KV S EIB M8X25	U-Scheibe M8 Ø25 	8	M8	
KV MU TJ M8	Befestigungsmutter M8 	4	M8	
NG04	NÄGEL 2.5x50 Dachbretter Fussbodenbretter 	988		
SR32	SCHRAUBEN 3.0x30 Fussbodenleisten Traufenleisten 40x18 	48		
SR37	SCHRAUBEN 3.5x45 Giebelbretter, Traufenbretter Giebelsegment, Fenster- und Türleisten 	112		
SR57	SCHRAUBEN 5.0x100 Fundamenthölzer 	36		
	FENSTER <u>Q4</u> W4-S44P-06C-08601125  A58-3/W118-PC L1 18x95 L=1100mm 2x L2 18x95 L=1245mm 4x L3 18x95 L=860mm 2x ✓	1		

Teileliste 3

240570

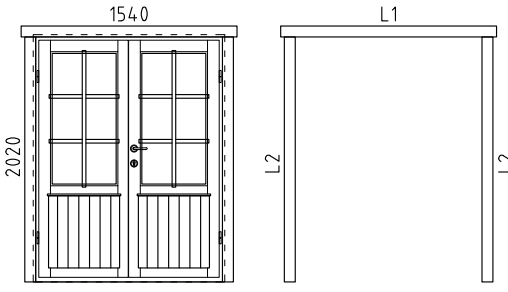
Pos		Stck	Profil (mm)	Länge (mm)
TÜR Q4	<p style="text-align: right;">D4-D44R-56C-15402020</p>  <p style="text-align: right;">TU3-SH/D201-RC</p> <p>L1 18x95 L=1780mm 2x L2 18x95 L=2020mm 4x ✓</p> <p style="text-align: right;">DIN rechts</p>	1		
	✓ - bitte selber anpassen (falls nötig!)			

Wandplan 1 und 2 240570

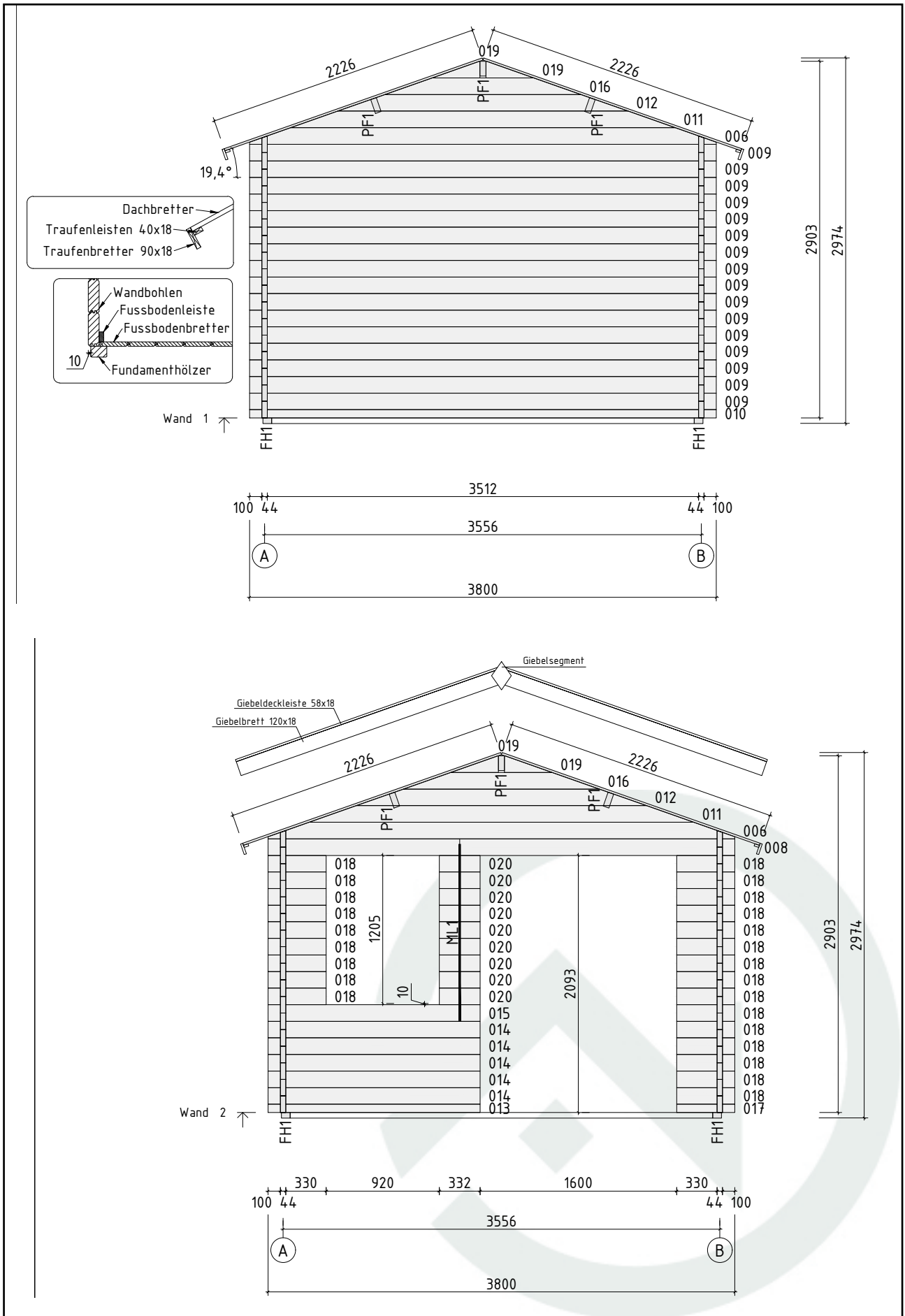

Wandplan A und B 240570

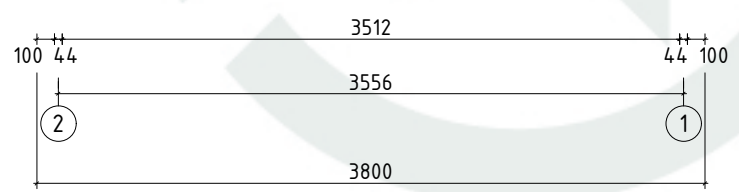
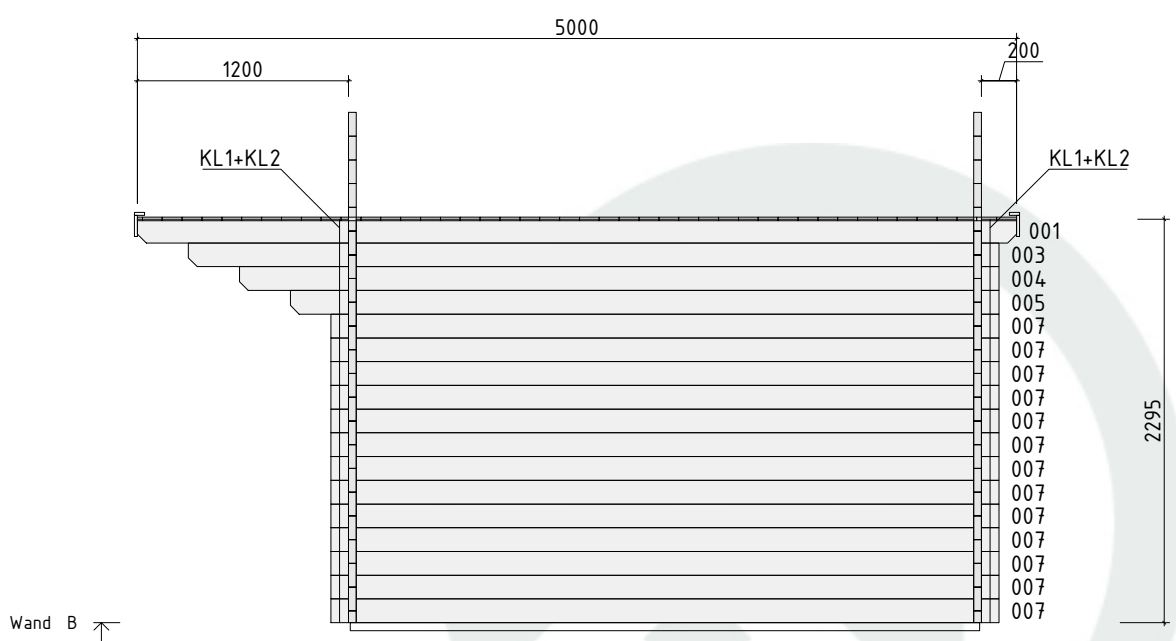
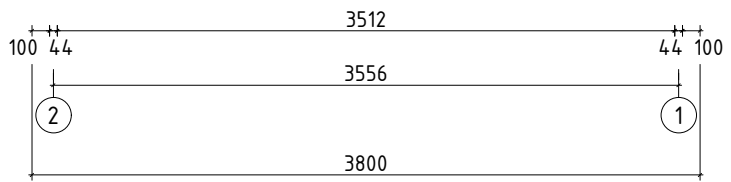
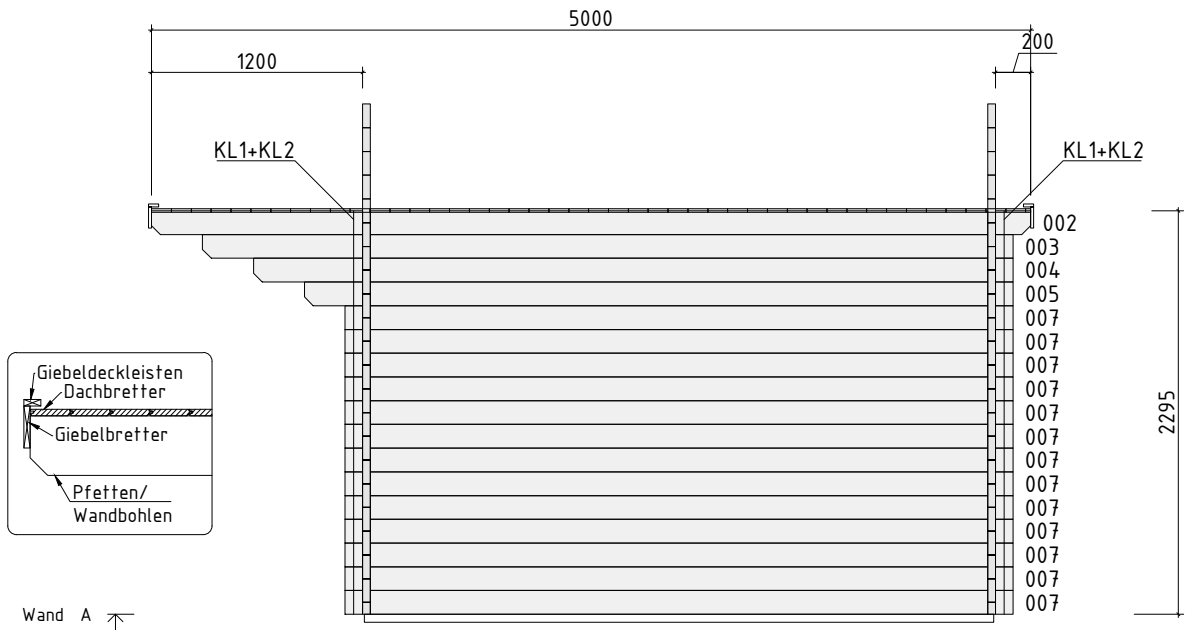

Details 240570

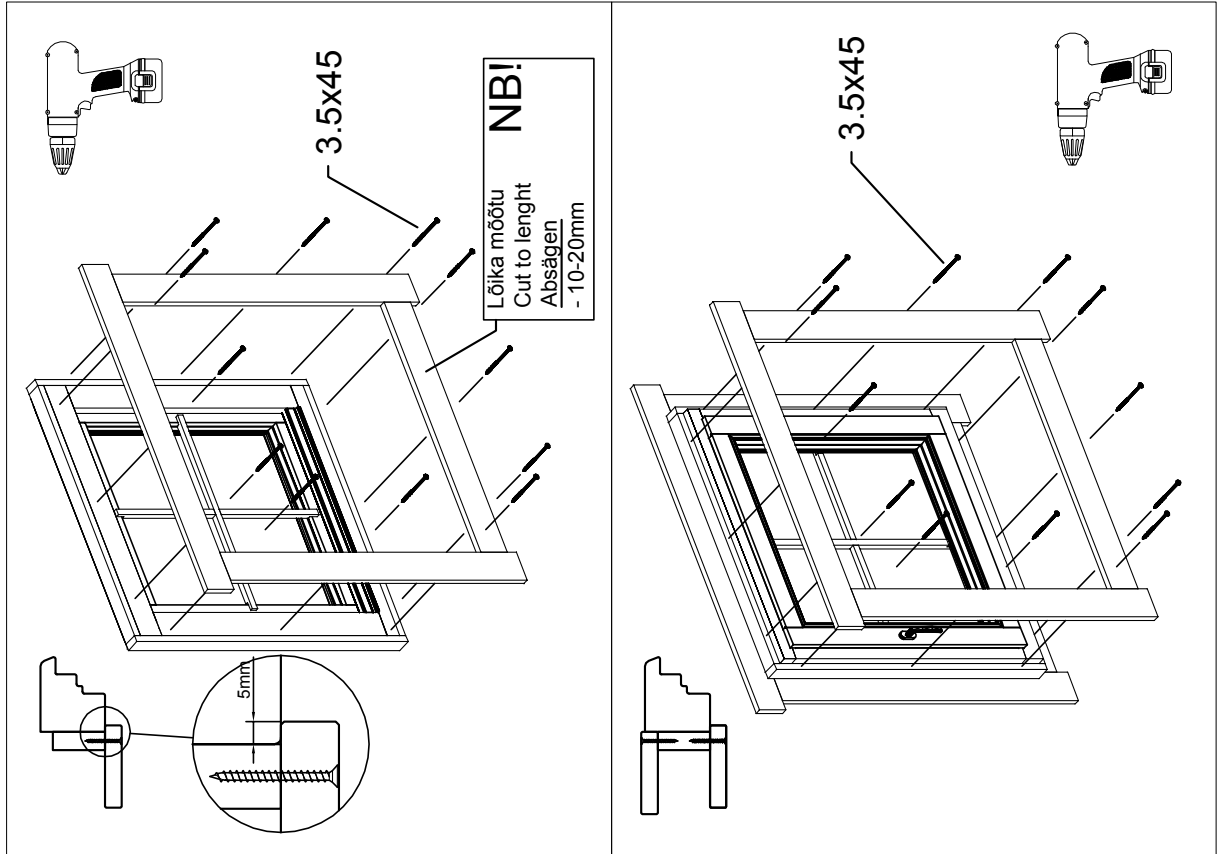

Akna tüüp / Fenster typ / Window type - A68
(GH+ / SH)

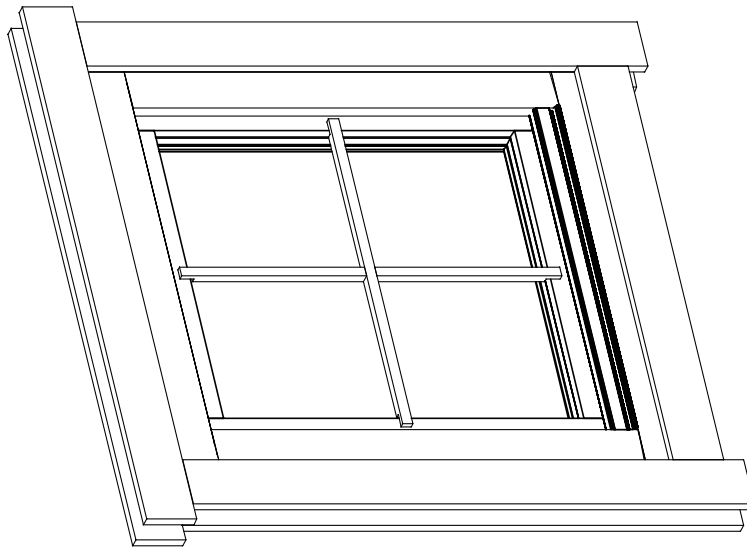

Details 240570



4.5x90

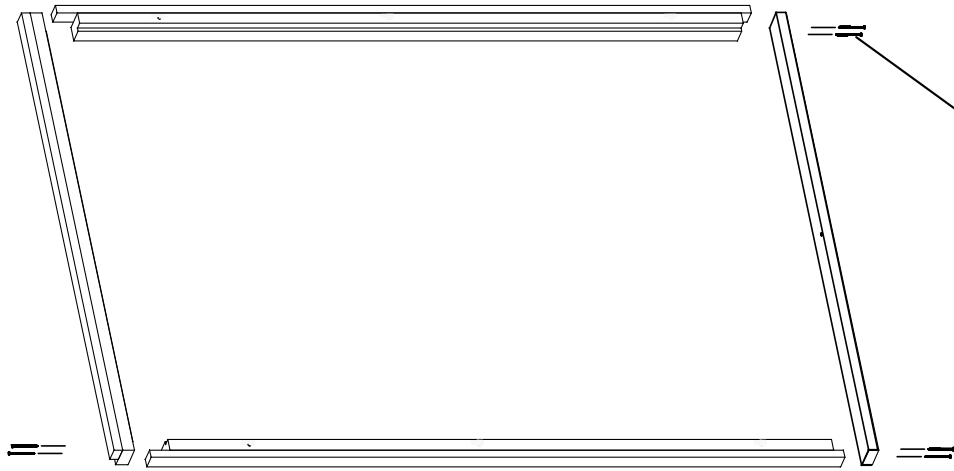

4.5x90

Ukse montaaž / Tür montage / Door assembly
(GH+ / SH)

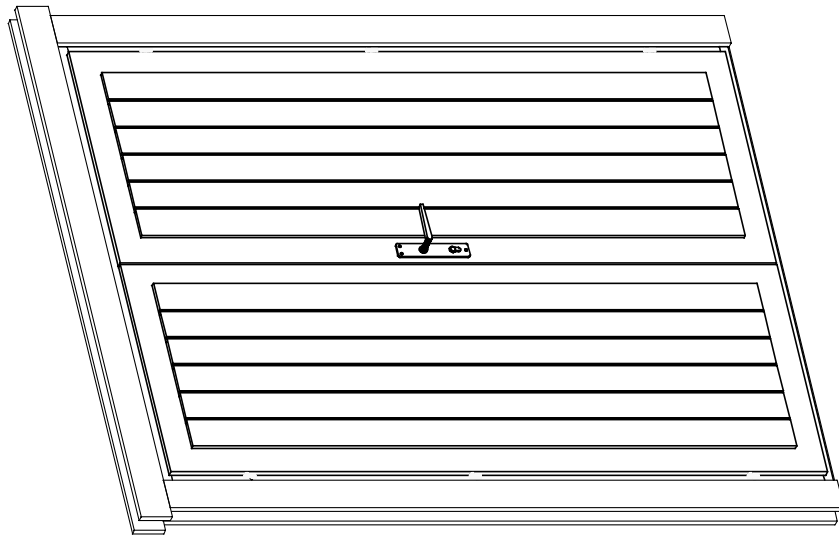

Details 240570

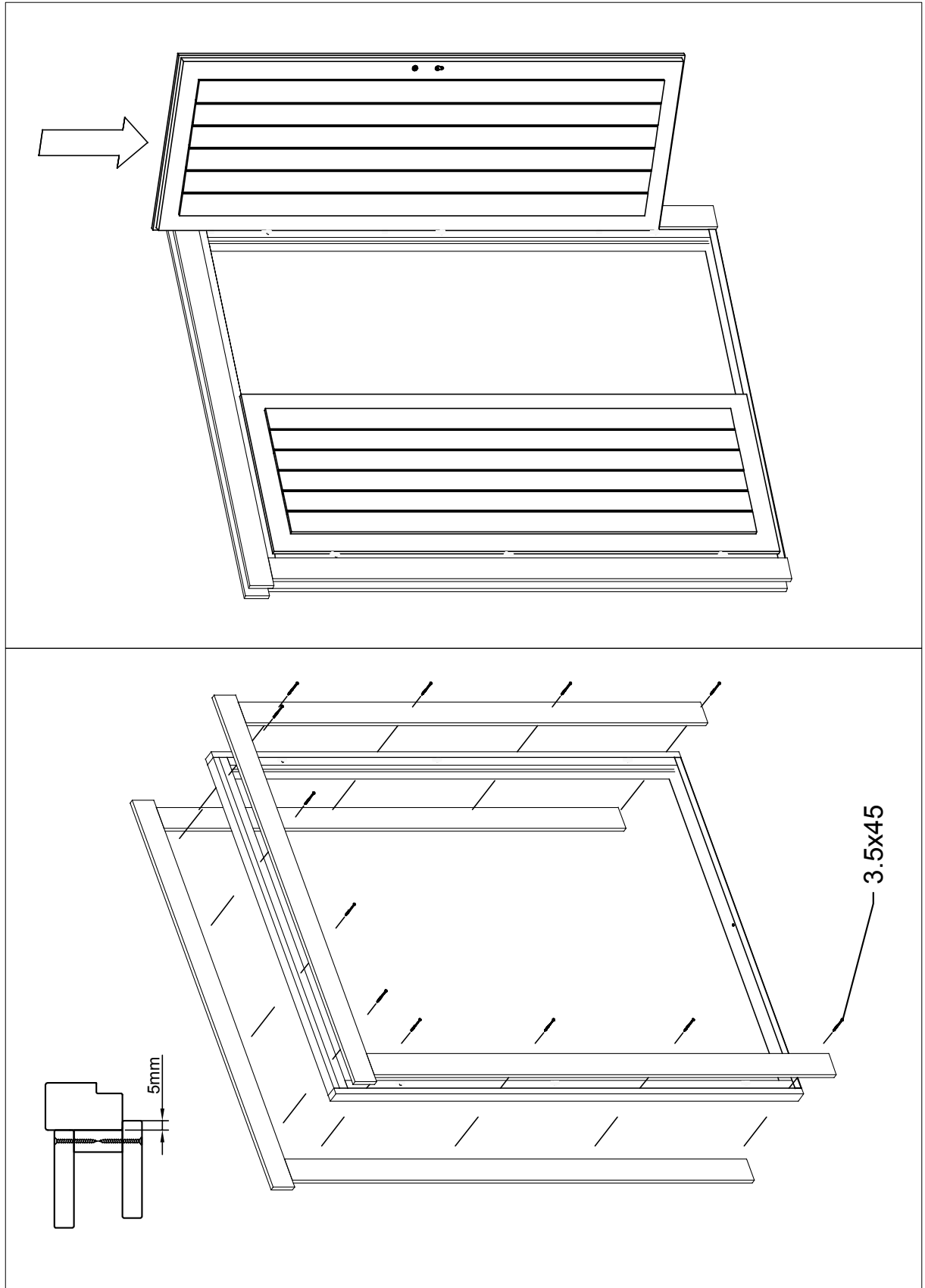

Details 240570

