

# Technische Daten: Art.-Nr.: 310401

Wandaußenmaß: Ø 200 x 400 cm  
Bohlenstärke: 42 mm



Abb. ähnlich!



Kontrolliert durch:

Empty box for signature or name.

Achtung: Alle angegebenen Maße sind ca.-Maße!

# Grundriss 310401

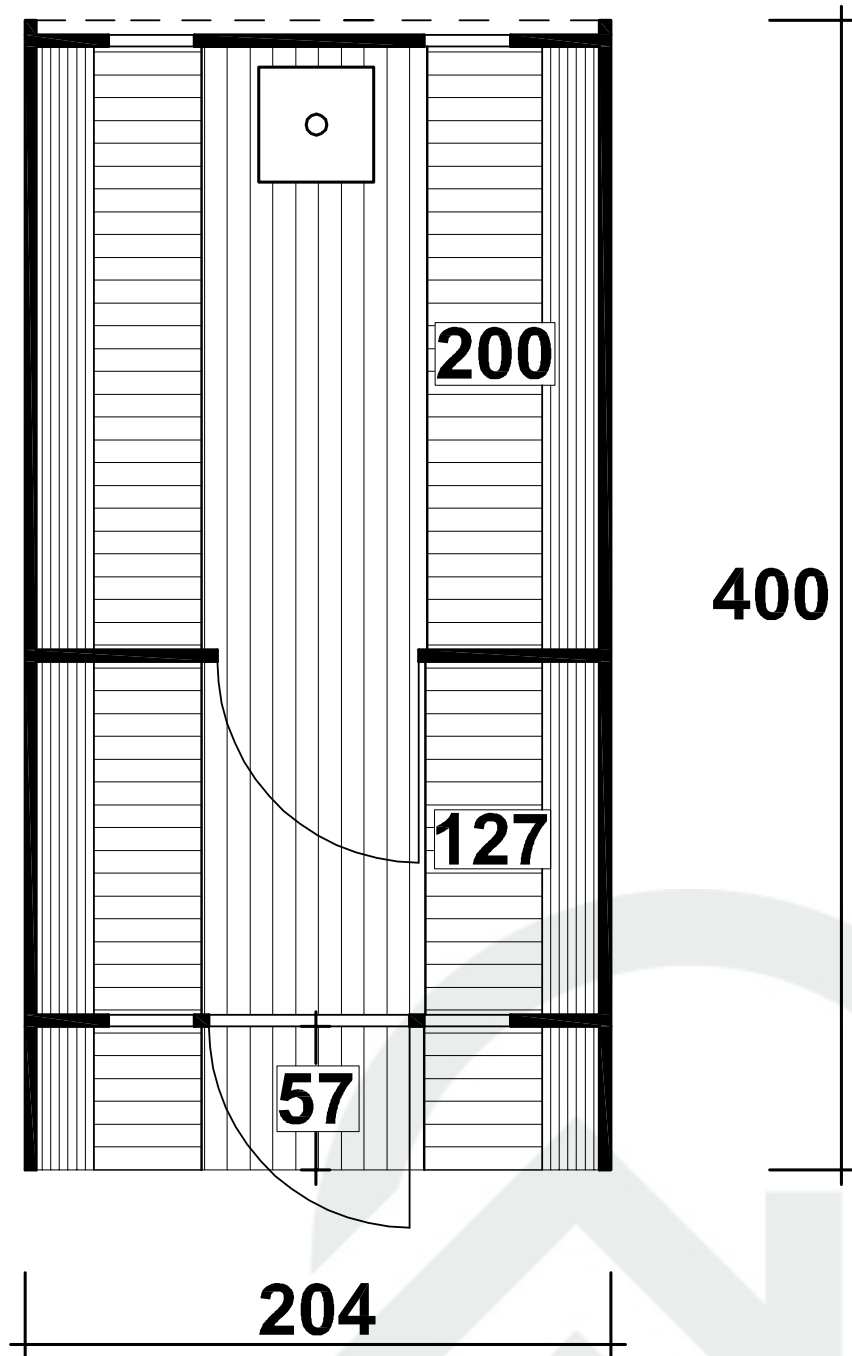

# Ansicht 1

## 310401

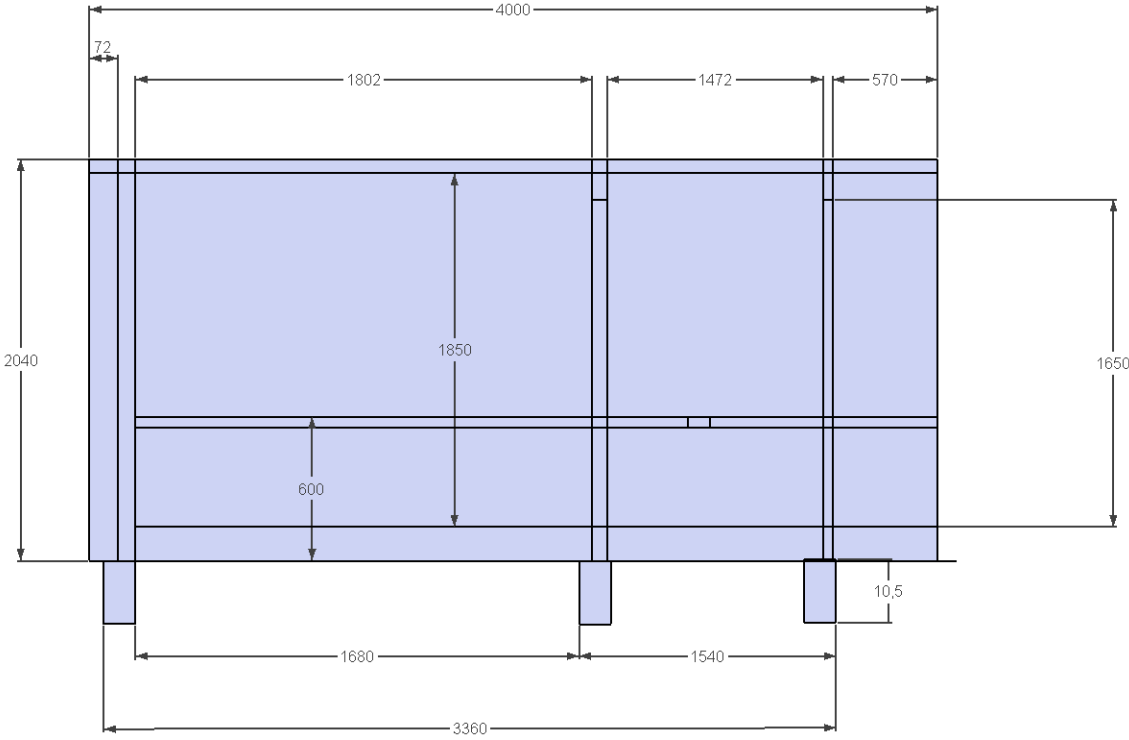

# Ansicht 2

## 310401

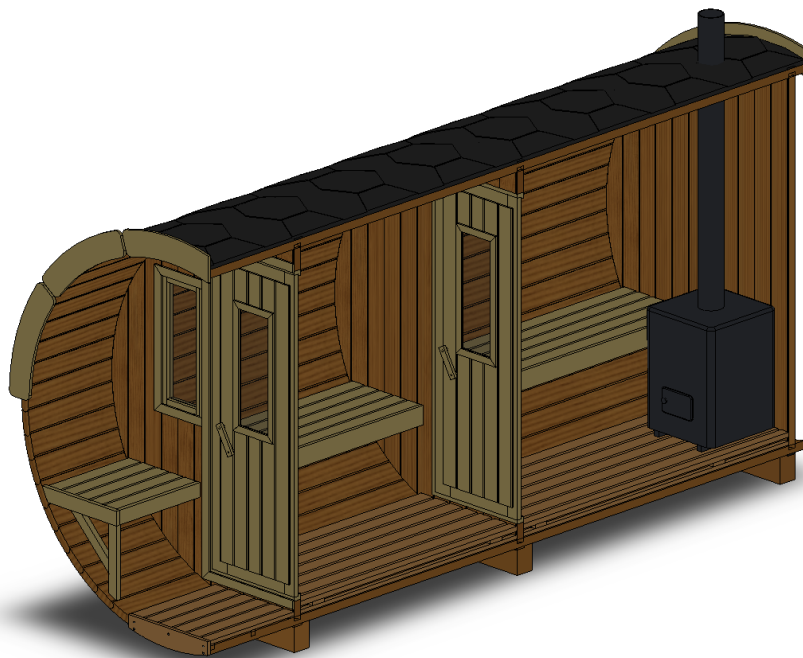

# Ansicht 3 310401

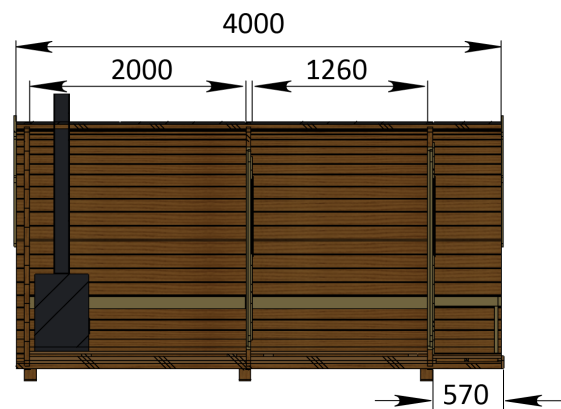
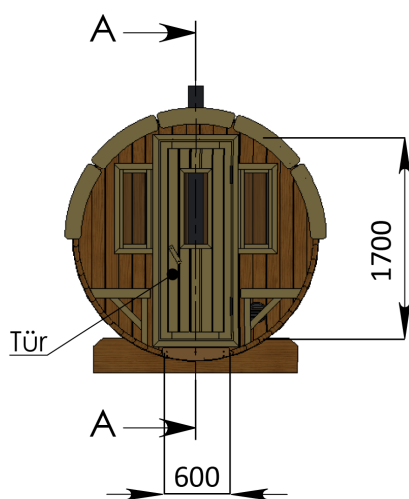
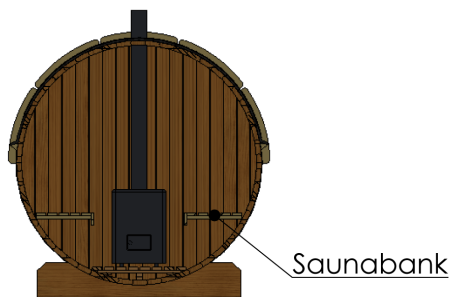
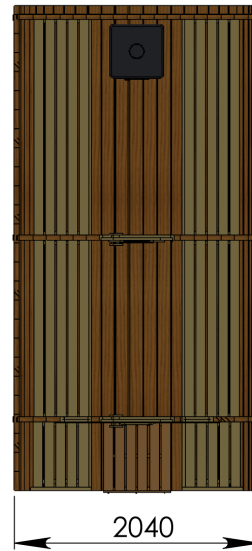
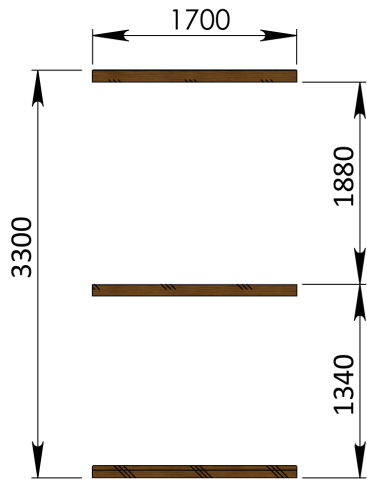

# Elektroofen

Saunaofen-Set 6-teilig 9 KW mit integrierter Steuerung für alle Saunafässer basic + de luxe



## Installation bei Elektroofen

Kontrolliert durch:

Achtung: Alle angegebenen Maße sind ca.-Maße!

# Elektroofen

Saunaofen-Set 6-teilig 9 KW mit integrierter Steuerung für alle Saunafässer basic + de luxe

## Installation bei Elektroofen

**Alle elektrischen Arbeiten müssen durch einen lizenzierten Elektriker durchgeführt werden !!!**

