

Technische Daten: Art.-Nr.: 350 160

Wandaußenmaß: 720 x 320 cm

Bohlenstärke: 70 mm



Kontrolliert durch:

Achtung: Alle angegebenen Maße sind ca.-Maße!

3D-Darstellung Art.-Nr. 350 160

Das Saunahaus lässt sich auch spiegelverkehrt aufbauen. Darum ist es erforderlich, die Fussbodenbretter und Terrassenbretter im Eingangsbereich laut beigefügter Zeichnung selbst zuzuschneiden.

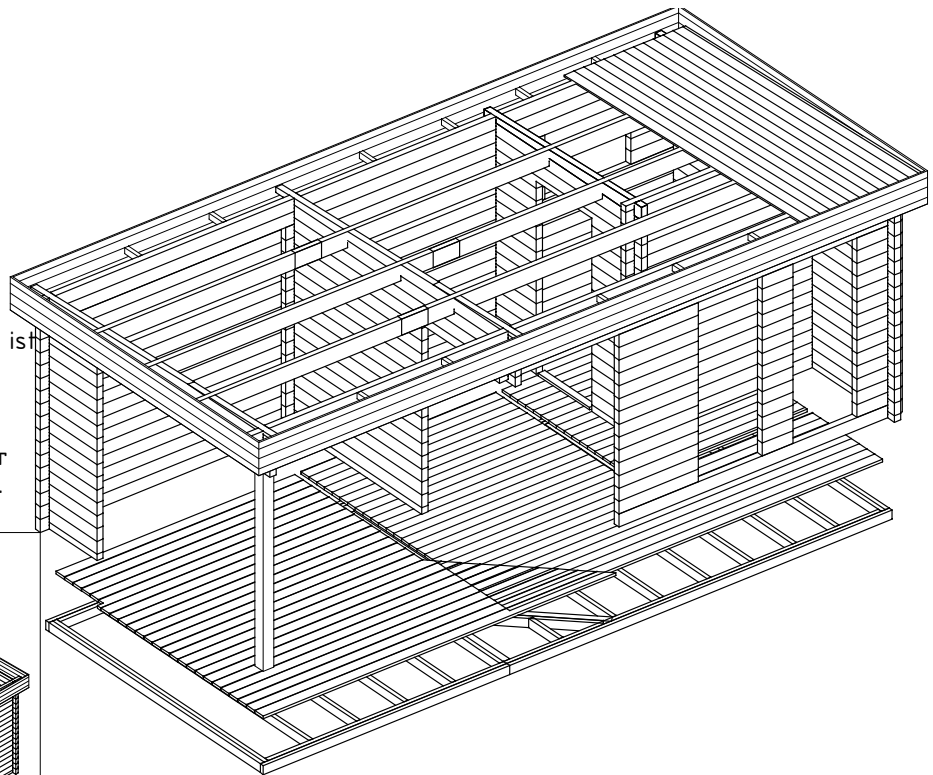
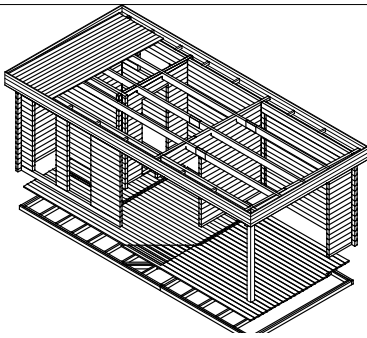

Grundriss Art.-Nr. 350 160

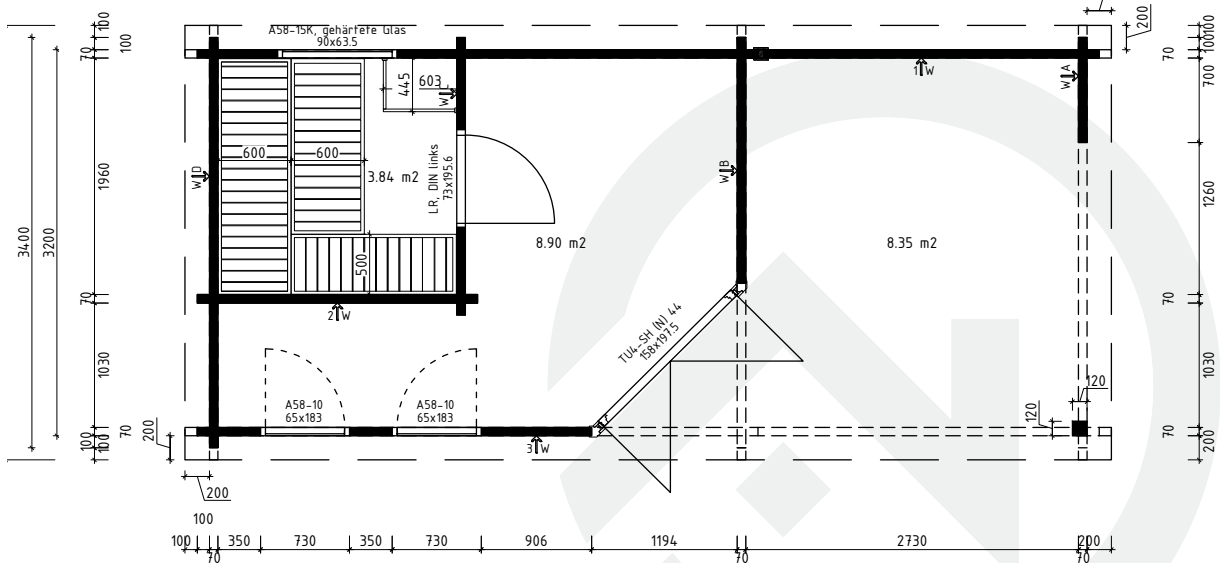
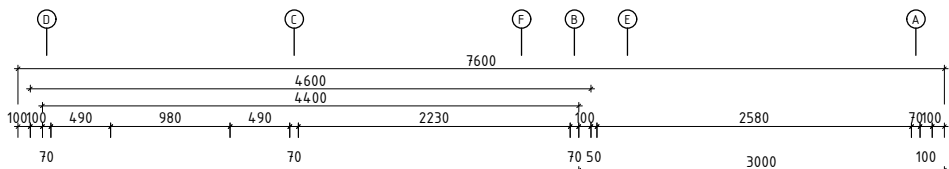
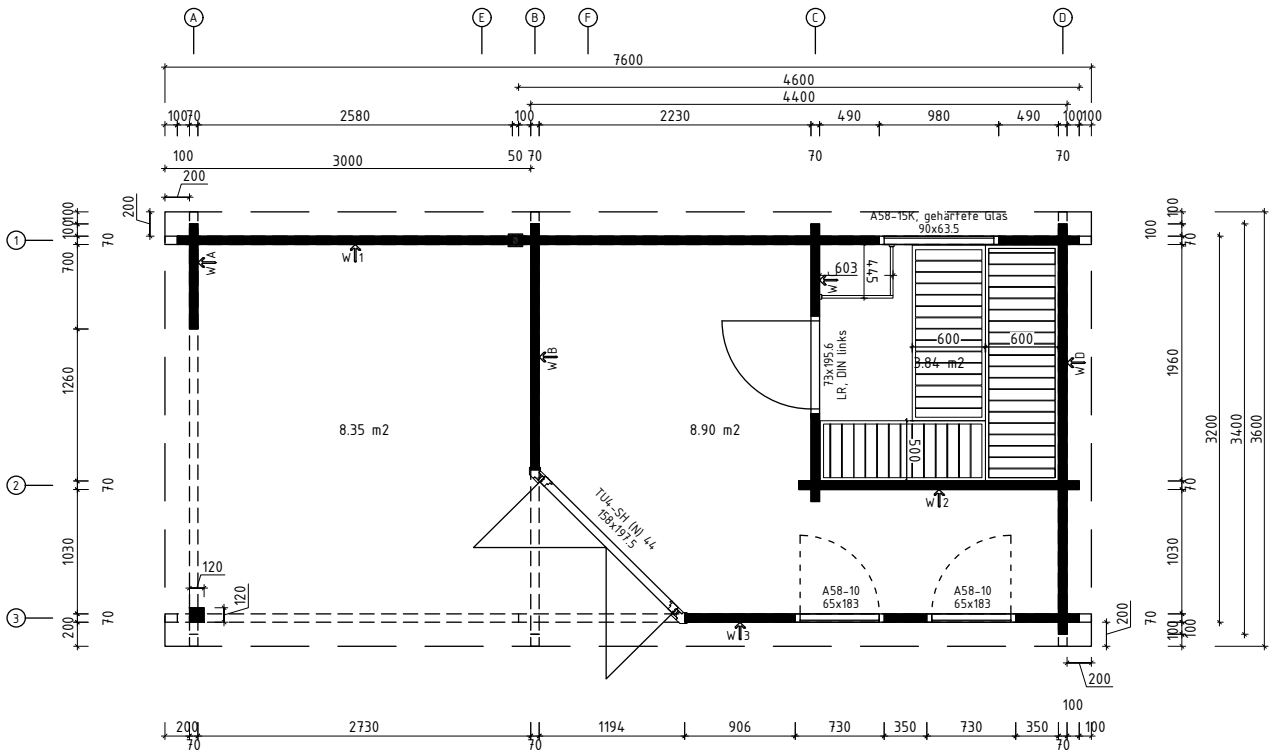

Lagerholzplan und Fundamentplan Art.-Nr. 350 160

Wir empfehlen als Fundament für Ihr Gartenhaus eine vollflächig festgegründete, gepflasterte oder betonierte Fläche.
Wahlweise ist auch ein Punkt- oder Streifenfundament möglich.

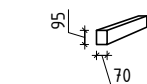
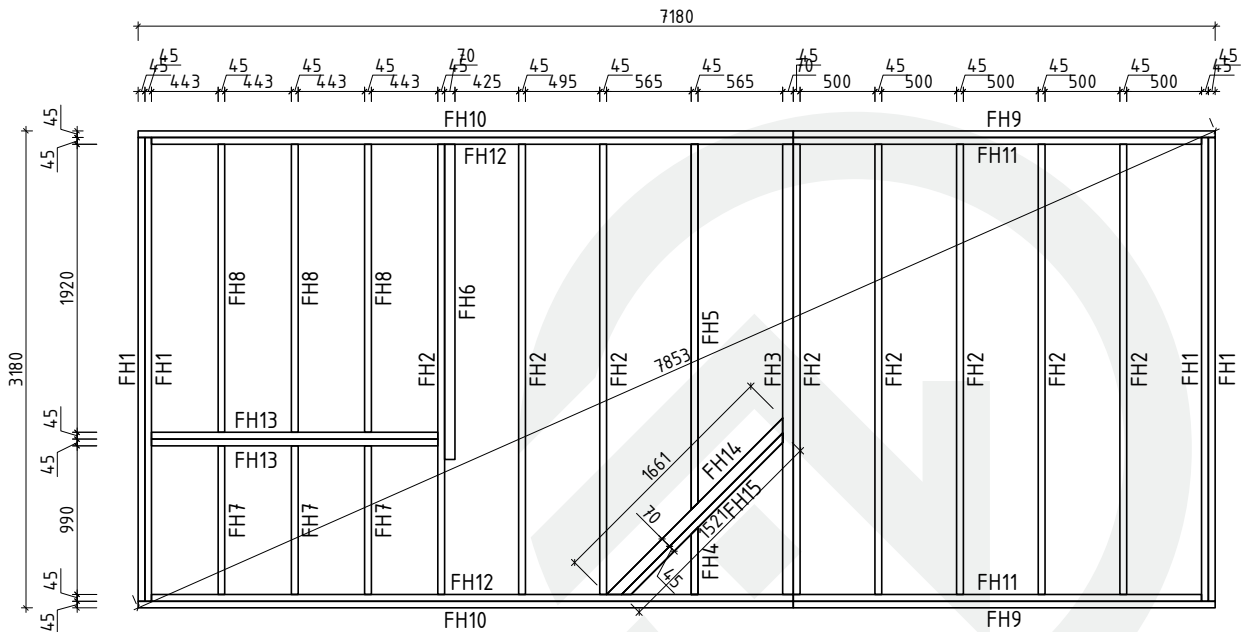
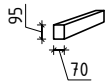
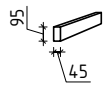
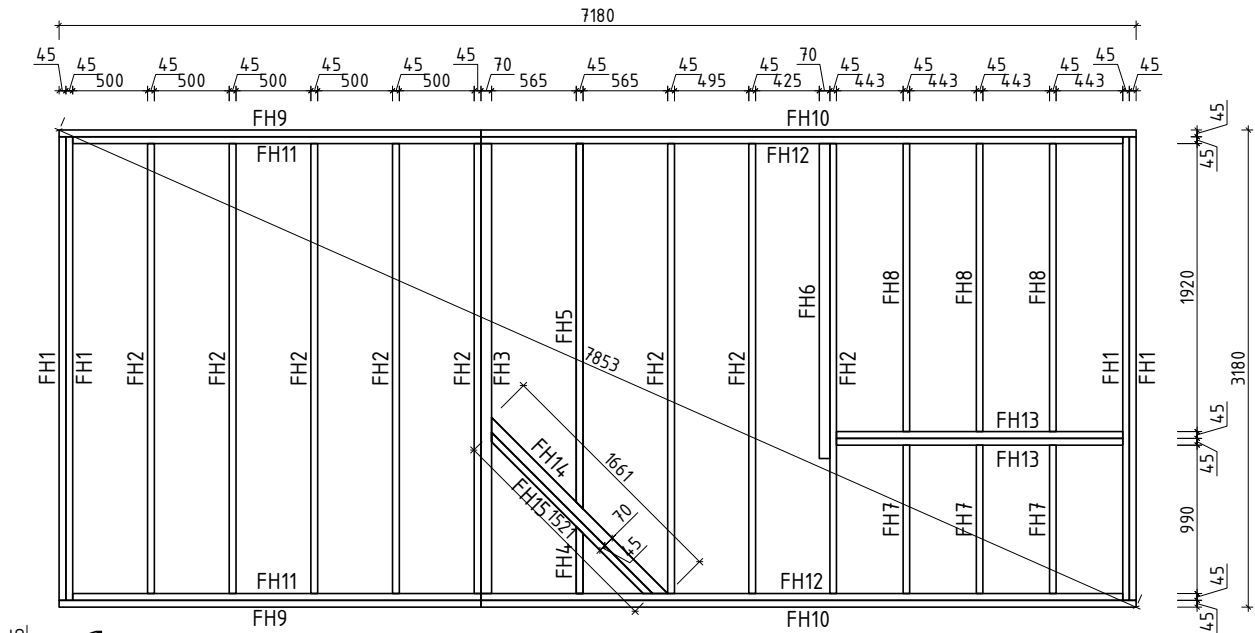

Teileliste 1

Art.-Nr. 350 160

Pos		Stck	Profil (mm)	Länge (mm)
001		1	70x135	5235
002		1	70x135	4617
003		1	70x135	4600
004		1	70x135	4600
005		9	70x135	4600
006		1	70x135	4600
007		1	70x135	4565
008		1	70x104	4565
009		1	70x135	4465
010		2	70x135	3600
011		1	70x135	3600
012		15	70x135	3400
013		2	70x135	3400
014		1	70x68	3400
015		1	70x135	3400
016		3	70x135	3400
017		1	70x135	3400
018		1	70x135	3236
019		1	70x104	3035
020		1	70x135	3035
021		5	70x135	2960
022		1	70x135	2935
023		1	70x135	2783
024		16	70x135	2750
025		1	70x135	2300



















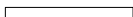

Teileliste 2

Artikel-Nr.: 350 160

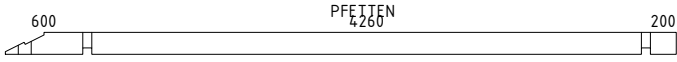
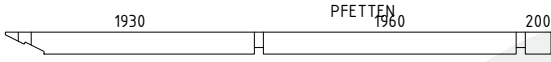
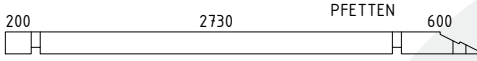
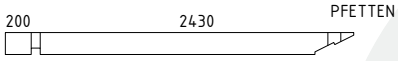
Pos		Stck	Profil (mm)	Länge (mm)
026		1	70x68	2300
027		20	70x135	2300
028		1	70x135	2300
029		1	70x135	2165
030		14	70x135	2036
031		1	70x68	2036
032		3	70x43	1300
033		7	70x135	906
034		4	70x135	906
035		3	70x135	906
036		8	70x135	870
037		4	70x135	870
038		3	70x135	870
039		1	70x68	870
040		1	70x68	763
041		14	70x135	763
042		1	70x68	728
043		14	70x135	728
044		5	70x135	660
045		14	70x135	520
046		10	70x135	350
047		4	70x135	350
FH3	FUNDAMENTHÖLZER (imprägniert) 	1	70x95	3000
FH6	FUNDAMENTHÖLZER (imprägniert) 	1	70x95	2100
FH14	FUNDAMENTHÖLZER (imprägniert) 	1	70x95	1661



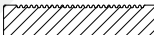
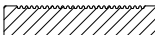









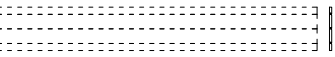



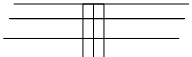





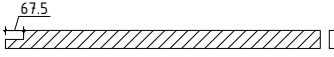

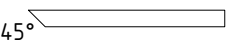

Teileliste 3

Artikel-Nr.: 350 160

Pos		Stck	Profil (mm)	Länge (mm)	
FH10	FUNDAMENTHÖLZER (imprägniert) 	2	45x95	4368	
FH12	FUNDAMENTHÖLZER (imprägniert) 	2	45x95	4278	
FH1	FUNDAMENTHÖLZER (imprägniert) 	4	45x95	3090	
FH2	FUNDAMENTHÖLZER (imprägniert) 	8	45x95	3000	
FH9	FUNDAMENTHÖLZER (imprägniert) 	2	45x95	2813	
FH11	FUNDAMENTHÖLZER (imprägniert) 	2	45x95	2723	
FH5	45° FUNDAMENTHÖLZER (imprägniert) 	1	45x95	2435	
FH8	FUNDAMENTHÖLZER (imprägniert) 	3	45x95	1920	
FH13	FUNDAMENTHÖLZER (imprägniert) 	2	45x95	1908	
FH15	45° FUNDAMENTHÖLZER (imprägniert) 45° 	1	45x95	1521	
FH7	FUNDAMENTHÖLZER (imprägniert) 	3	45x95	990	
FH4	45° FUNDAMENTHÖLZER (imprägniert) 	1	45x95	447	
HS1	HOLZSCHWELLE (unter der Saunatür) 	✓	75x28	750	
PF2	600 2230 PFETTEN 1960 200 	1	58x170	5200	
PF5	600 PFETTEN 4260 200 	1	58x170	5200	
PF4	1930 PFETTEN 1960 200 	1	58x170	4230	
PF3	200 2730 PFETTEN 600 	1	58x170	3670	
PF1	200 2430 PFETTEN 	2	58x170	2700	
	DACHBRETTER 	68+1	113x18	3500	
	FUSSBODENBRETTER 	✓	10+1	113x28	4255
	FUSSBODENBRETTER 	18	113x28	2225	
	FUSSBODENBRETTER 	18	113x28	1955	
	TERRASSENBRETTER (imprägniert) 	✓	10+1	120x28	2904-4029
	TERRASSENBRETTER (imprägniert) 	15	120x28	2795	
	ABDECKLEISTEN 	✓	15x28	23.0lfm	

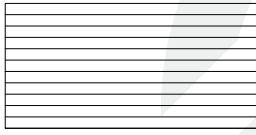

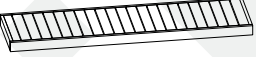
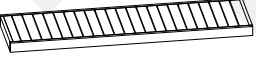
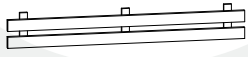







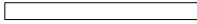
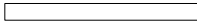
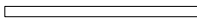
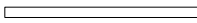
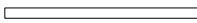



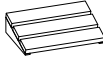
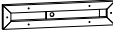

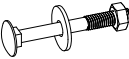

Teileliste 4

Artikel-Nr.: 350 160

Pos		Stck	Profil (mm)	Länge (mm)
	FUSSBODENLEISTEN  ✓		14x55	23.0lfm
BL-1	DACHBLENDEN 336mm  	2	18x336	3600
BL-2	DACHBLENDEN 336mm  	4	18x336	3818
BS-1	DACHBLENDEN- Blendenstützen 44x65 	12	44x65	200
VL-1	DACHBLENDEN- Verbindungsleisten 	2	18x120	336
UPB-1	DACHBLENDEN- U-Profil für Blenden  40 ✓		65x44	23.0lfm
DPL-1	DACHPAPPENLEISTEN 15x28  ✓		15x28	15.0lfm
T06-1	TRAUFENLEISTEN 18x40  ✓		18x40	15.5lfm
A70-1	ADAPTER 70  Obere seite  ✓	1	120x106	2260
TP1 20-1	STÜTZPFOSTEN 120x120  67.5 ✓	1	120x120	2090
TL70-1	T-LEISTE 70 	2	45x70	625
TL7 0-2	T-LEISTE 70 	4	45x70	1840
TL7 0-3	T-LEISTE 70 	2	45x70	1910
DzT 58-1	ECKTÜR- Deckbrett zum Tür 58 	1	18x58	1750
VK3-1	ECKTÜR- Verkleidungsleisten 95 für Vordachelement  45°  ✓	2	95x18	1250
P9L4-1	ECKTÜR- linke Türpfoste 70  40 	1	90x90	2035
P9R 4-1	ECKTÜR- rechte Türpfoste 70  40 	1	90x90	2035
VE3	ECKTÜR- Vordachelement 1600x825 	1		
	DECKENISOLATION  	2 Elemente	ca 1950x975	
SA0 2-1	SAUNA - Saunabank 50cm 	1	500x90	1355
SA01-1	SAUNA - Saunabank 60cm 	2	600x90	1955
SA16-1	SAUNA - Bänke Zwischenstück 	1	40x300	1955
SA15-1	SAUNA - Rücklehne 	2	40x250	1860











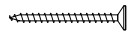

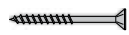
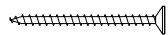

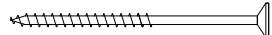
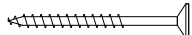
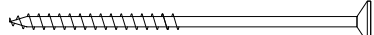
Teileliste 5

Artikel-Nr.: 350 160

Pos			Stck	Profil (mm)	Länge (mm)	
SA11-1	SAUNA - Stützpfeiler für Saunabänke		✓	1	44x65	500
SA11-2	SAUNA - Stützpfeiler für Saunabänke		✓	2	44x65	1000
SA10-1	SAUNA - Trägleiste für Saunabänke		✓	1	30x40	500
SA10-2	SAUNA - Trägleiste für Saunabänke		✓	2	30x40	600
SA10-3	SAUNA - Trägleiste für Saunabänke		✓	2	30x40	1200
SA20-1	SAUNA - Trägleiste für Deckenisolation		✓	4	35x35	2010
SA37	SAUNA - Bodenrost			1		
SA30	SAUNA - Heizung Umbau (set 1)			1		
SA35	SAUNA - Kopfstütze			2		
SA36	SAUNA - Luftschieber			3		
SA25-1	SAUNA - Dichtungsband für Deckenisolationselemente		✓			8.0lfm
HK2	HOLZ-KLOTZEN für verbinden der Wandbohlen (122mm)			1		
SH	Schlaghölzer			3		
KP-1	DACHPAPPE		✓		8.3m-5'st	45.0lfm
SS023	Schloßschrauben M8x70 Mutter M8 U-Scheibe Ø25 - Befestigung für Saunabänke			2		
VS	VERBINDUNGSSTREIFEN für verbinden der Wandbohlen			4		
VP3	Verstellbare Pfostenstütze M20			1		
ML1	Metallstange			1	D10	1040
ML2	Metallstange			1	D10	970
ML3	Metallstange			5	D10	900
ML4	Metallstange			2	D10	770
ML5	Metallstange			5	D10	360
ML6	Metallstange			1	D10	330
NG01	DACHPAPPNÄGEL 2.8x15			560		
NG04	NÄGEL 2.5x50			680		
		Dachbretter				

Teileliste 6

Artikel-Nr.: 350 160

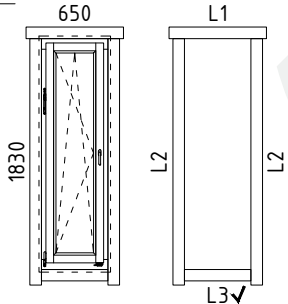
Pos			Stck	Profil (mm)	Länge (mm)
SR32	SCHRAUBEN 3.0x30	Abdeckleisten, Fussbodenleisten, Verbindungsleisten Dachpappenleisten, Traufenleisten 40x18 Bänke Zwischenstück, Luftschieber		191	
SR37	SCHRAUBEN 3.5x45	Heizung Umbau, Verbindungsstreifen		24	
SR3 547	SCHRAUBEN 3.5x45 C3	Fenster- und Türleisten		128	
SR3 547	SCHRAUBEN 3.5x45 C3	U-Profil		48	
SR44	SCHRAUBEN 4.0x60	Trägleiste für Saunabänke Trägleiste für Deckenisolation, Rücklehne		61	
SR4 257	SCHRAUBEN 4.2x55 C2	28mm Fussbodenbretter		289	
SR4 267	SCHRAUBEN 4.2x65 C3	28mm Terrassenbretter		350	
SR57	SCHRAUBEN 5.0x100	Fundamenthölzer Stützpfeiler 120x120		145	
SR55	SCHRAUBEN 5.0x70	Blendenbefestigung Verstellbare Pfostenstütze Stützpfeiler für Saunabänke		74	
SR61	SCHRAUBEN 6.0x140	Blendenstützen		24	
KL-1	Gewindestange M12 - für die Pfetten		6		170
MUT26	Mutter M12 U-Scheibe Ø30 - für die Pfetten		12		
KL1	Gewindestange M8		3		2000
KL2	Gewindestange M8		1		564
KL3	Gewindestange M8		1		509
KL4	Gewindestange M8		2		460
KL5	Gewindestange M8		1		374
KV M UT M8	Mutter M8		10		
KV S EIB M8X25	U-Scheibe M8 Ø25		10		
KV MU TJ M8	Befestigungsmutter M8		3		
	FENSTER Q4	 <p style="text-align: center;">650</p> <p style="text-align: center;">L1</p> <p style="text-align: center;">1830</p> <p style="text-align: center;">L2</p> <p style="text-align: center;">L2</p> <p style="text-align: center;">L3✓</p> <p>A58-10 spez</p> <p>L1 18x90 L=850mm 2*</p> <p>L2 18x90 L=1910mm 4*</p> <p>L3 18x90 L=610mm 2* ✓</p> <p>1x DIN links / 1x DIN rechts</p>	650x1830	2	

Wandplan 1

Art.-Nr. 350 160

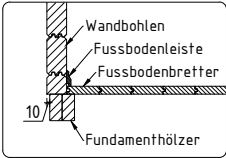
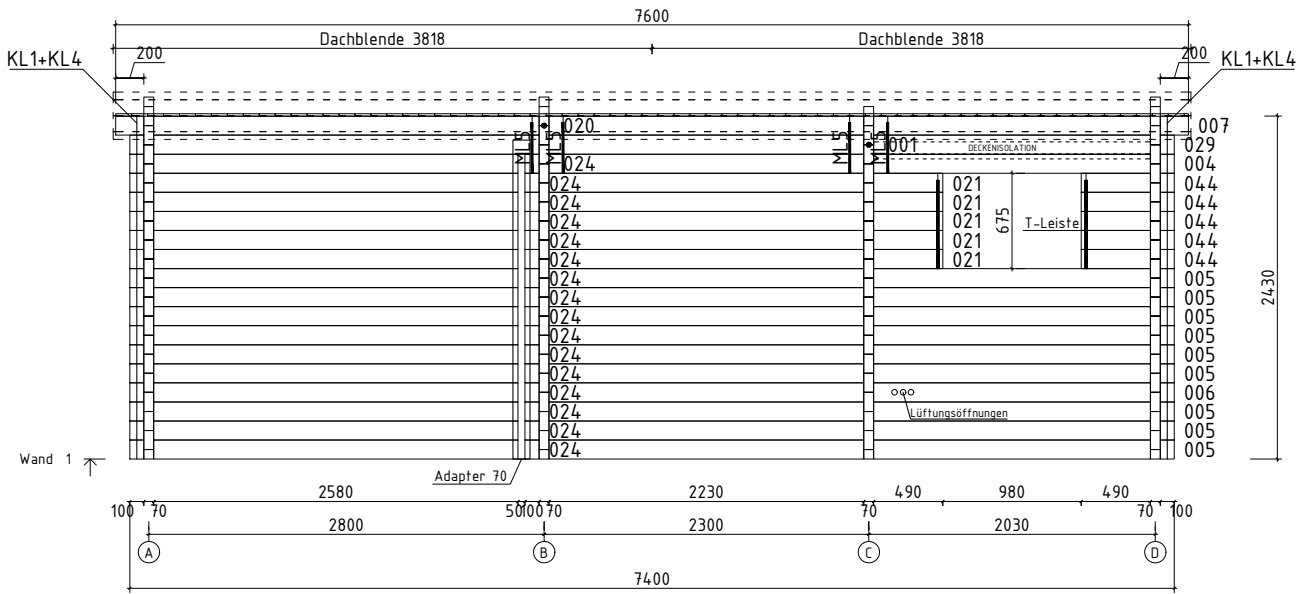

Die Bohlen mit Lüftungöffnungen können je nach Bedarf höher oder niedriger eingesetzt werden. Bitte achten Sie darauf, dass die Lüftungöffnungen von innen nicht mit der Saunabank bedeckt werden!



Wandplan 2

Art.-Nr. 350 160

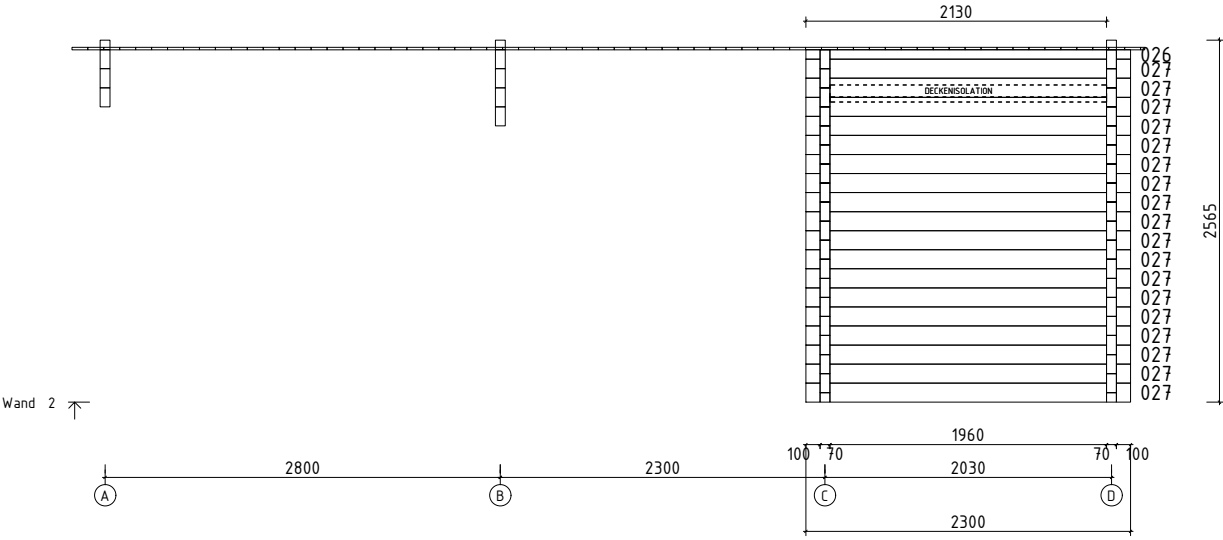

Wandplan 3 Art.-Nr. 350 160

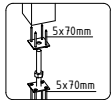
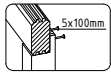
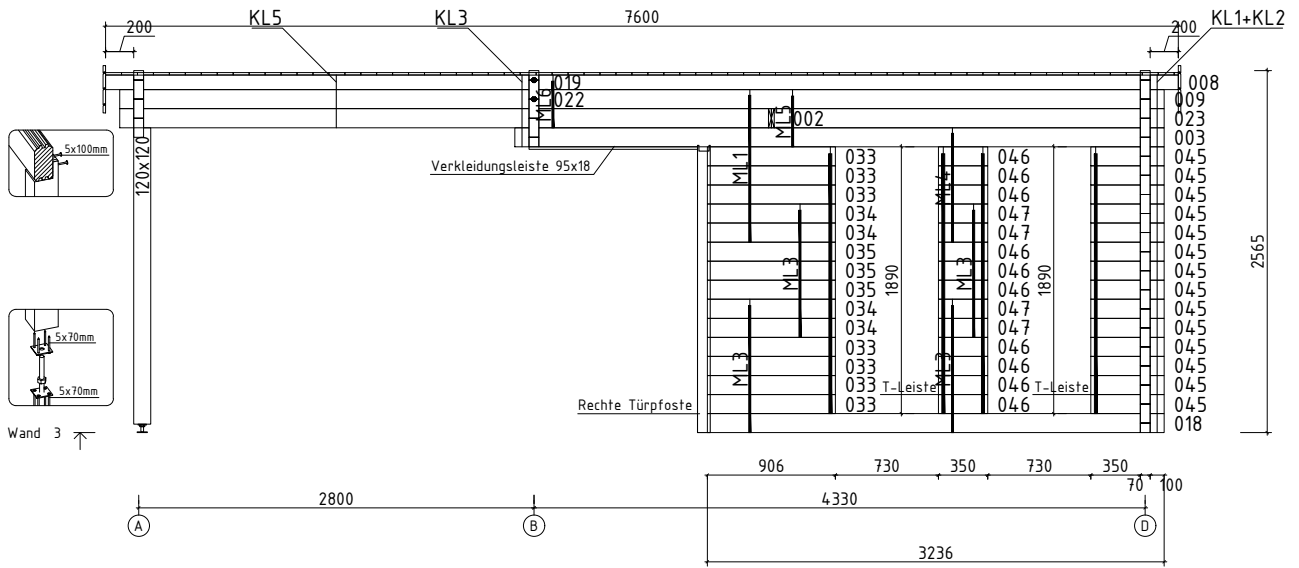

Wand 3 ↗

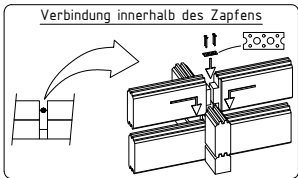

Wandplan A

Art.-Nr. 350 160

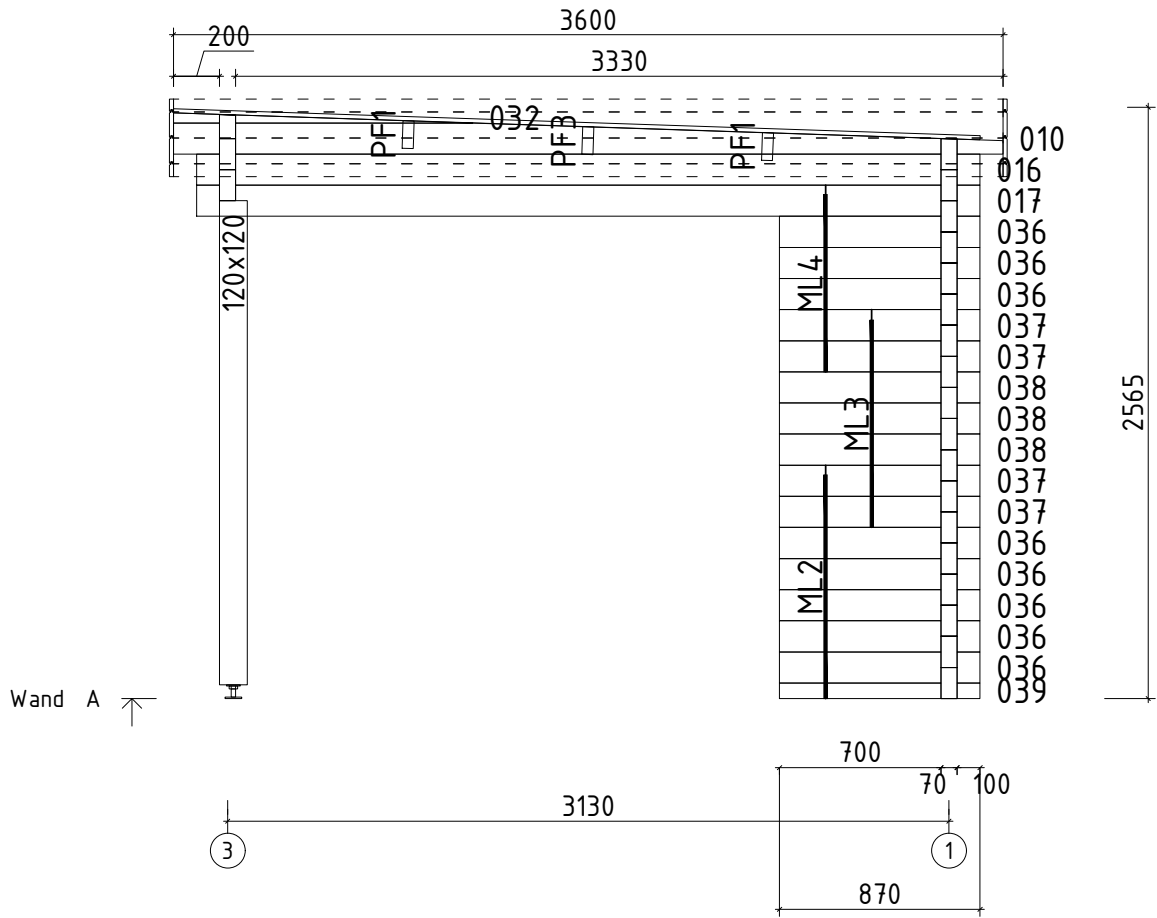

Wandplan B

Art.-Nr. 350 160

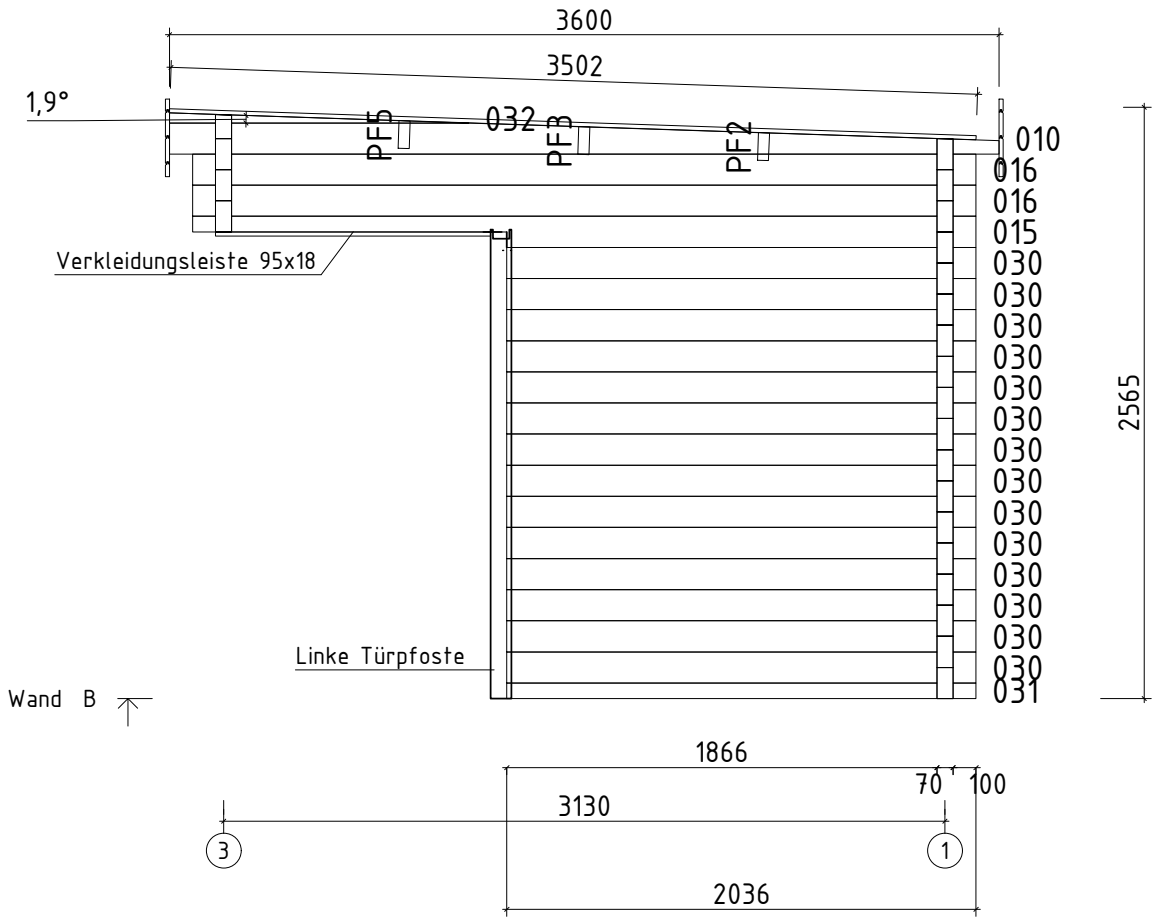

Wandplan D

Art.-Nr. 350 160

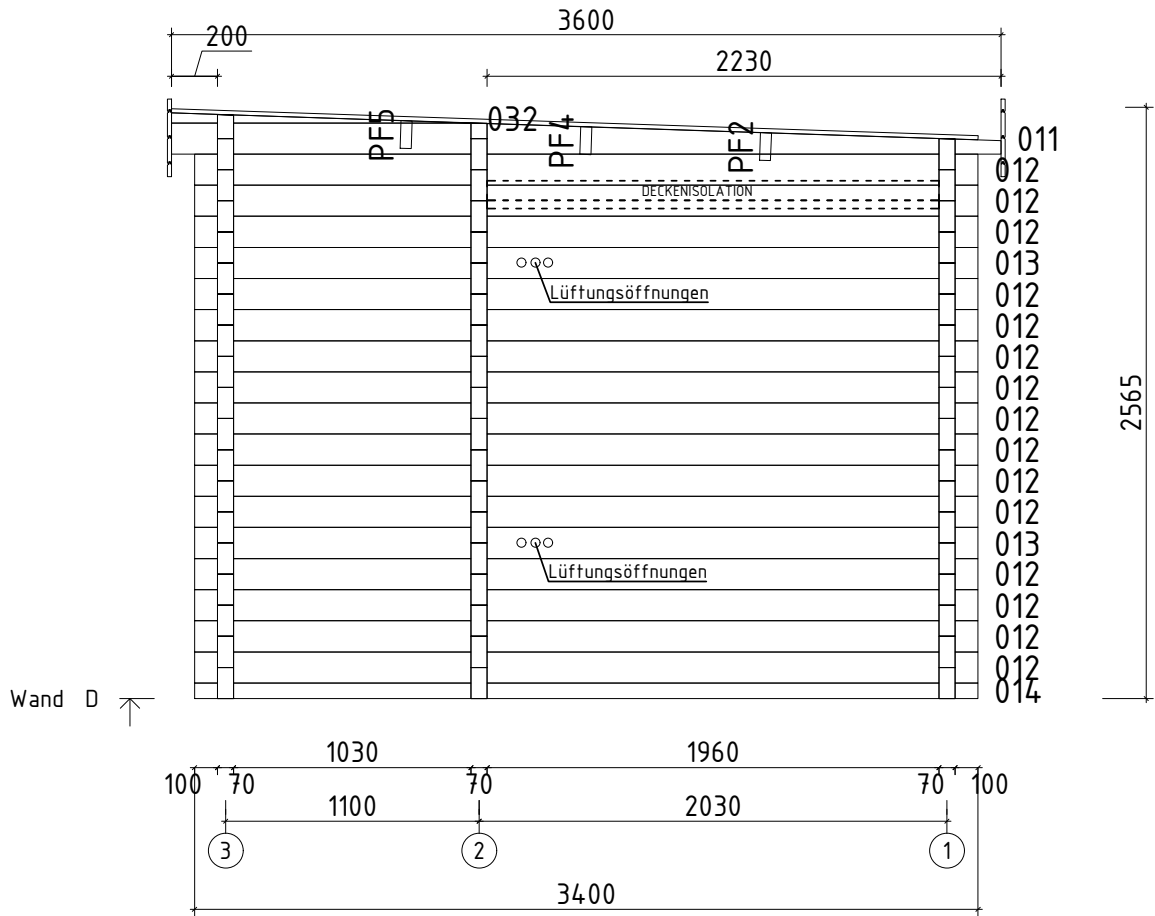

Montage T-Leisten

Art.-Nr. 350 160

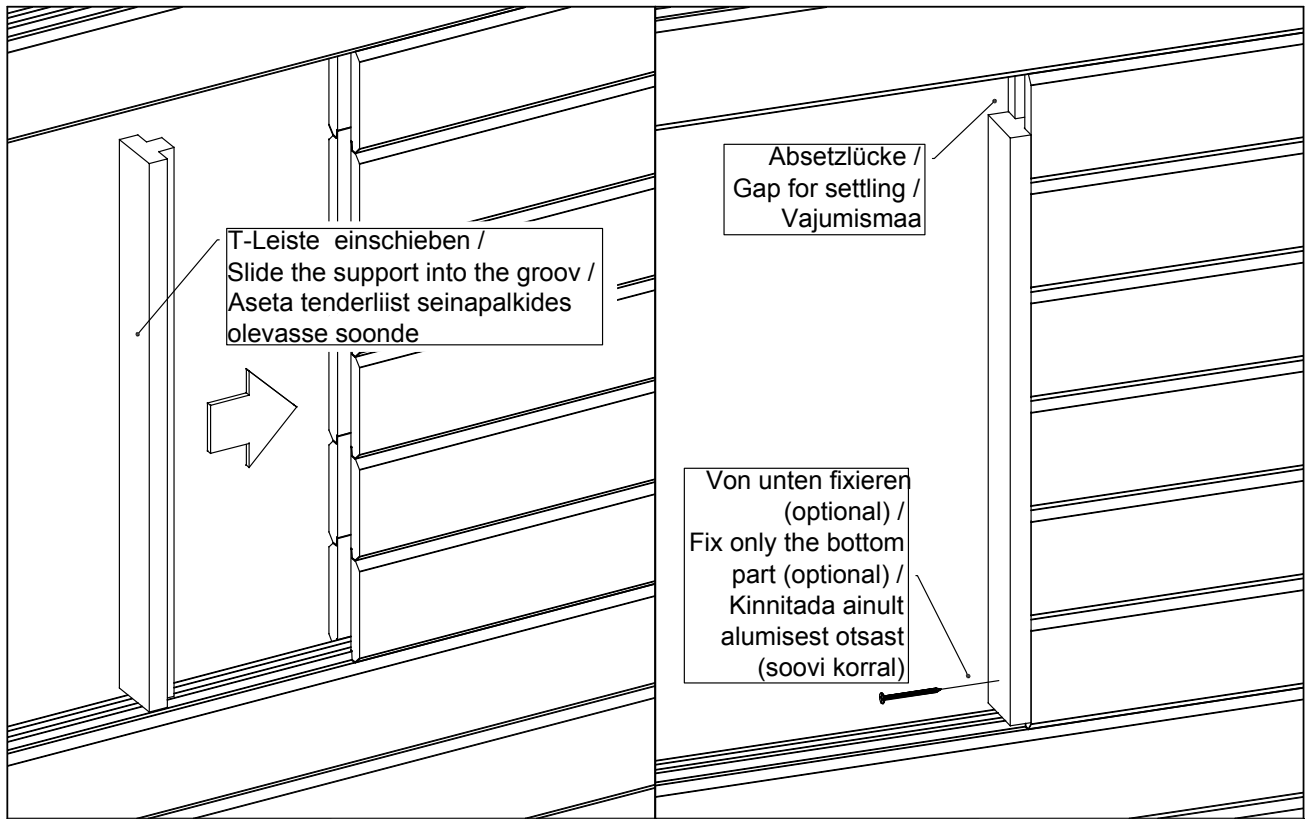

Fenstermontage

Art.-Nr. 350 160

Aken Q4-Q6 - paigaldusjuhised
 Window Q4-Q6 - assembly instructions
 Fenster Q4-Q6 - Montageanleitung

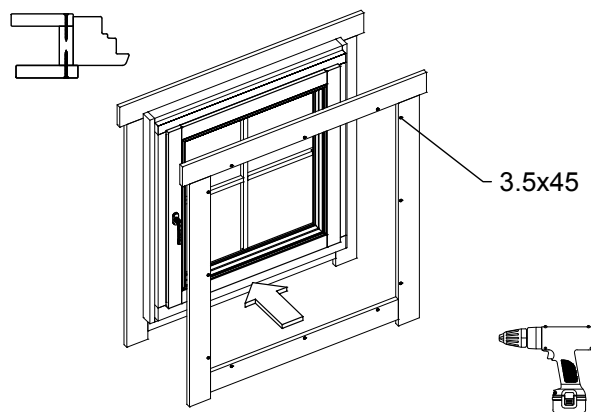
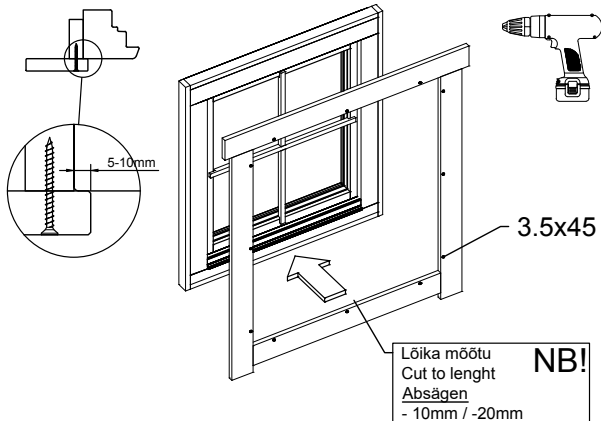
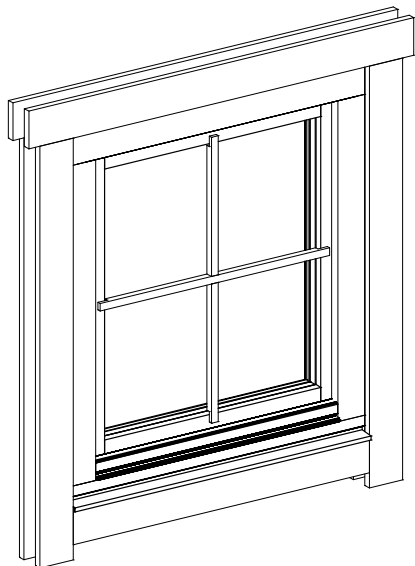

Fenstermontage

Art.-Nr. 350 160

Veeplekk / Window sill / Fensterbank

Q4

1

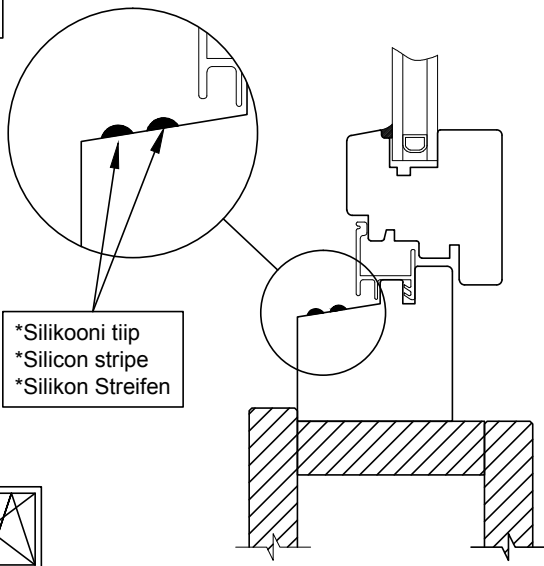

2

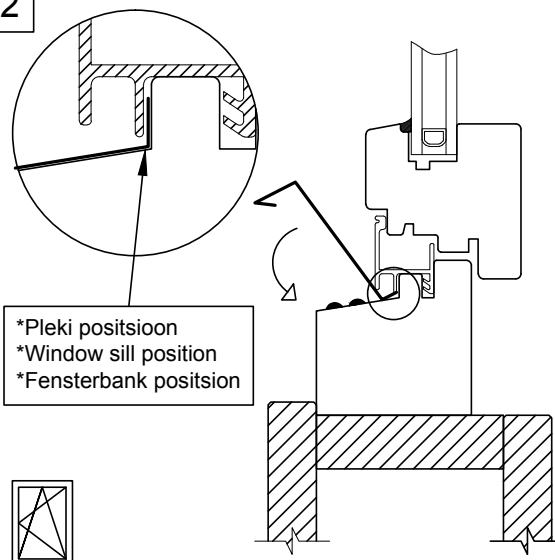

3

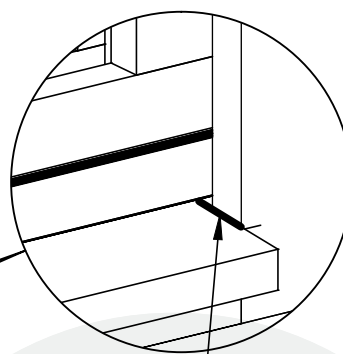
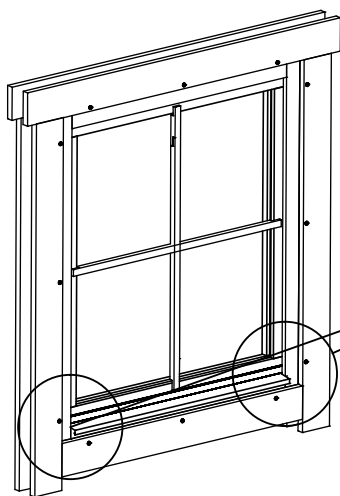

*Silikooni tiip
*Silicon stripe
*Silikon Streifen

1

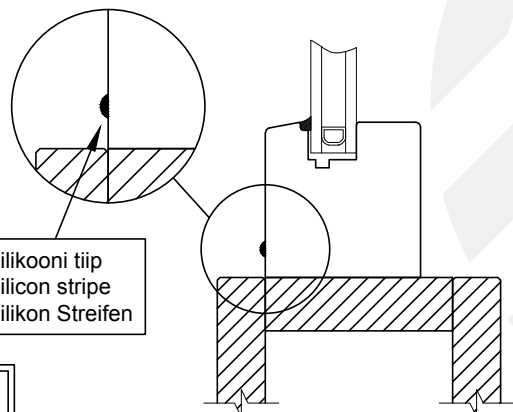

2

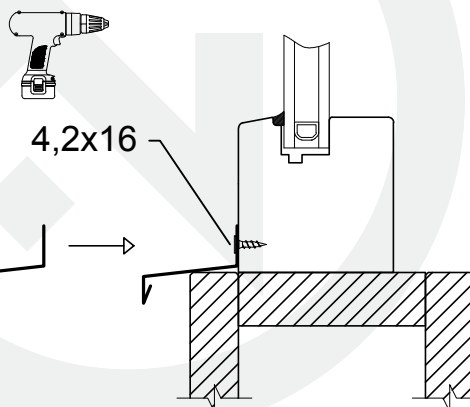

Türmontage

Art.-Nr. 350 160

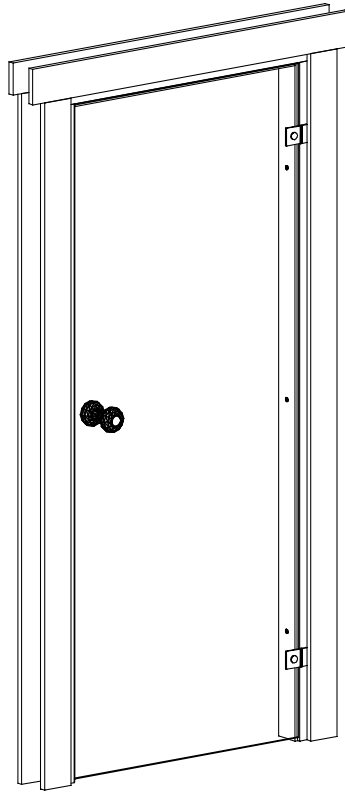

18x90 Blendleisten/
cover strips/piirdeliistud

Rahmenleisten
20x Wandstärke/
frame extensions
20x wall thickness/
laienduslist
20x seina paksus

18x90 Blendleisten/
cover strips/piirdeliistud

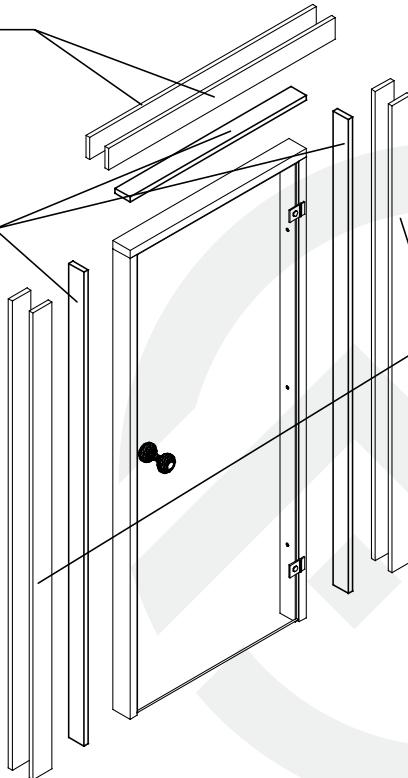

Türmontage

Art.-Nr. 350 160

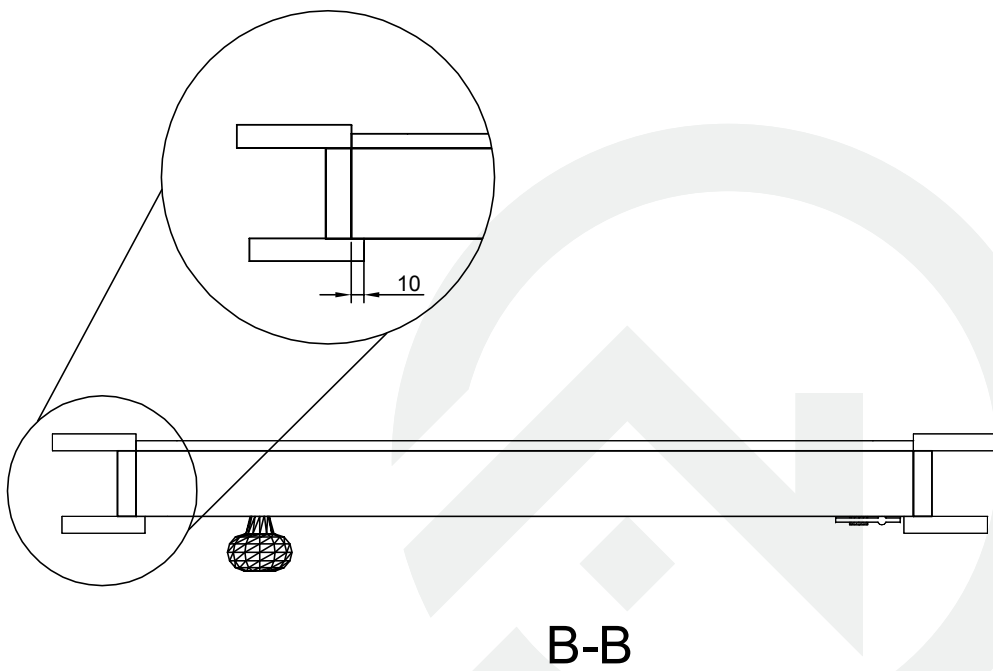
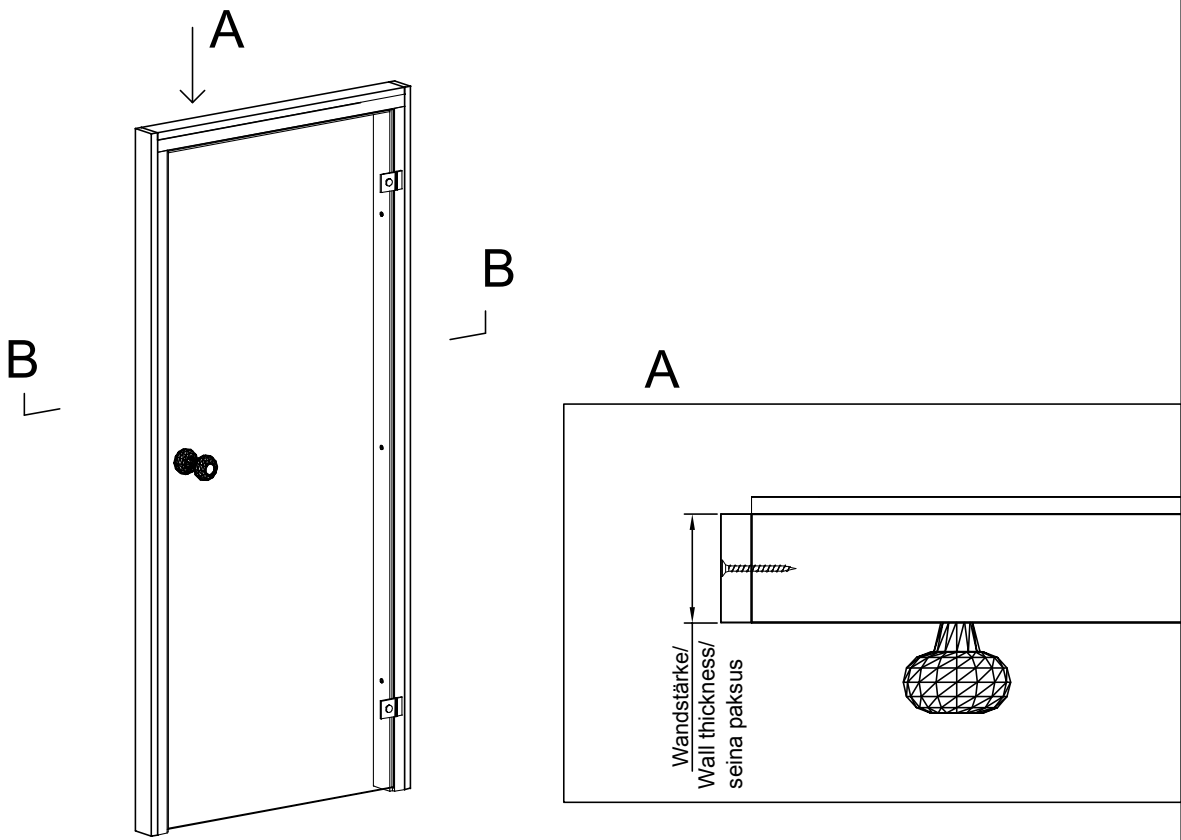

Türmontage

Art.-Nr. 350 160

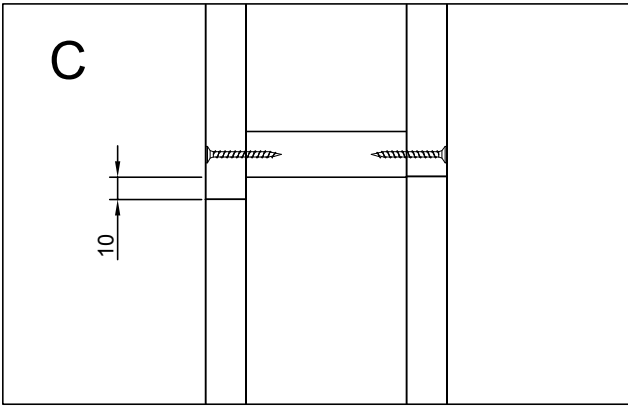
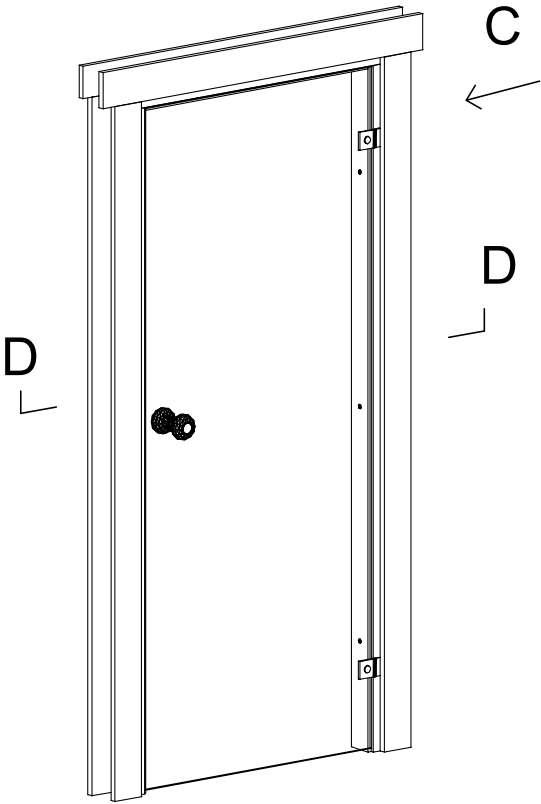

D-D



Einsetzen der Saunabänke Art.-Nr. 350 160

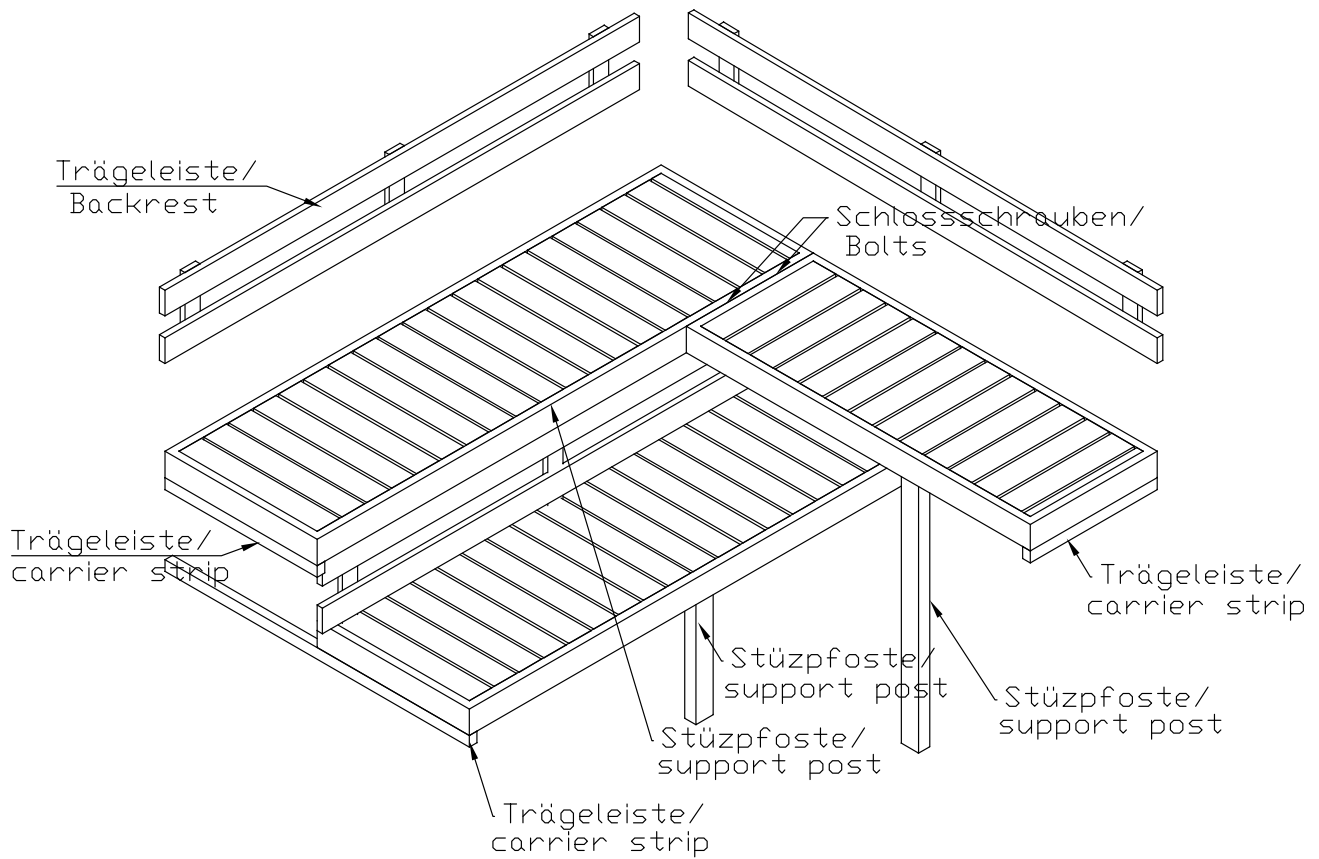

Montage Bänke und Zwischendecke

Art.-Nr. 350 160

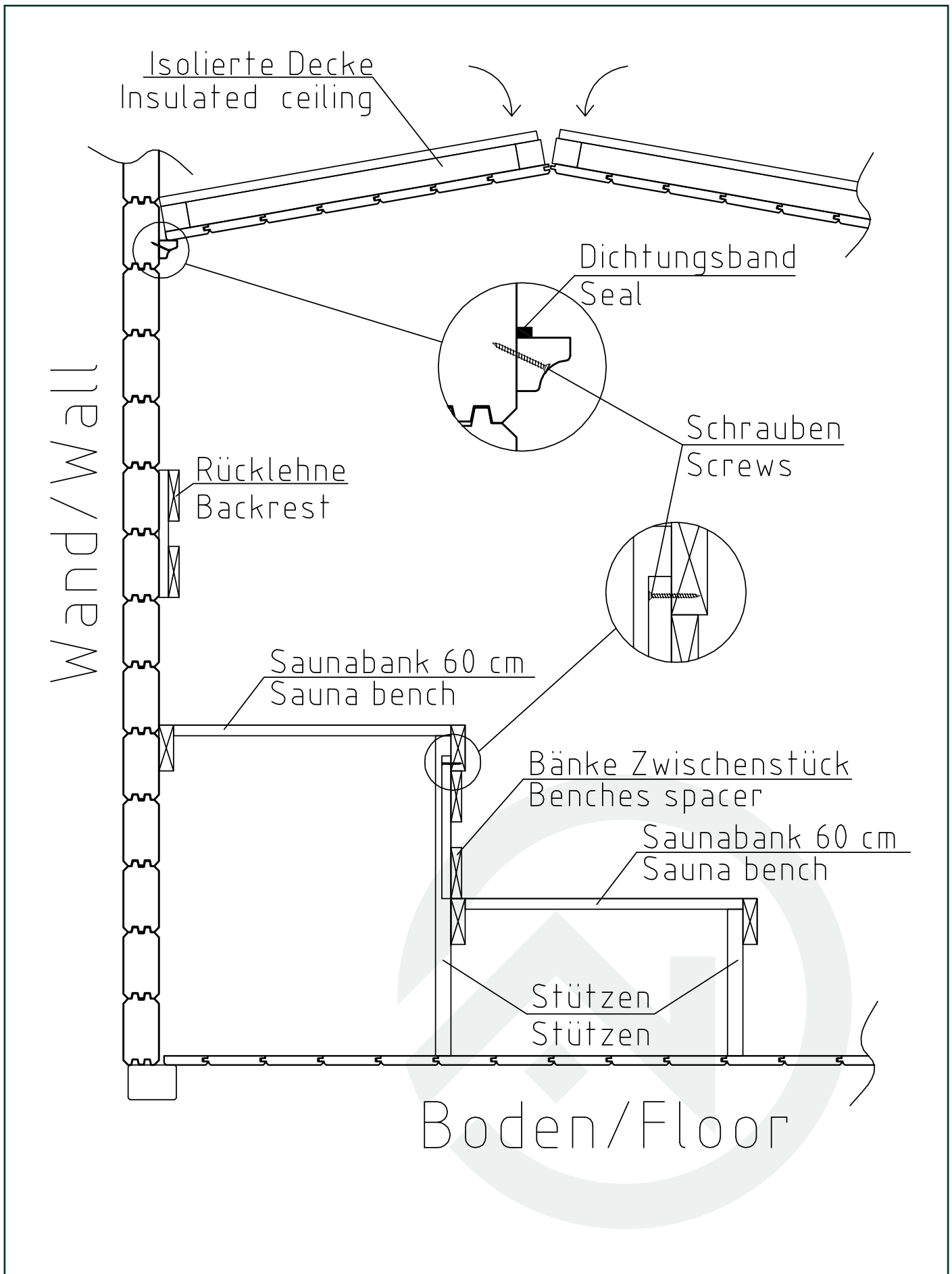

Vordachelement / Schnitt

Art.-Nr. 350 160

Step 1: Dachelement an den Wänden verschrauben.
Step 1: Screw canopy element to the wall.

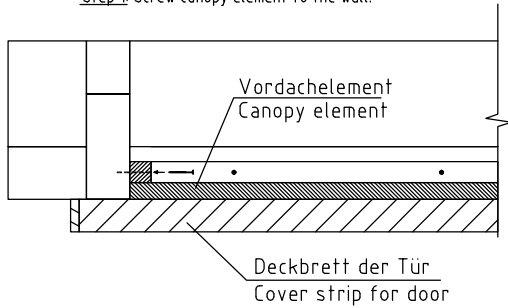

Step 3: Die Verkleidungsteisten in die richtige Länge schneiden und unter das VD-Element befestigen.
Step 3: Cut trim strips to size and fasten under the VD-element.

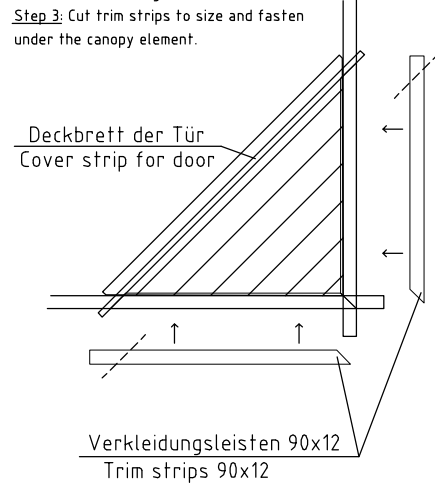

Step 2: Das Deckbrett muss von oben (durch das VD-Element) an das Dachelement verschraubt werden.
Step 2: Fasten cover strip to the canopy element.

