

# Technische Daten Maria 44-A

Wandaußenmaß: 300 x 300 cm

Bohlenstärke: 44 mm



Durch Kunden farblich endbehandelt

Kontrolliert durch:

Achtung: Alle angegebenen Maße sind ca.-Maße!

# 3D-Darstellung und Grundriss Maria 44-A

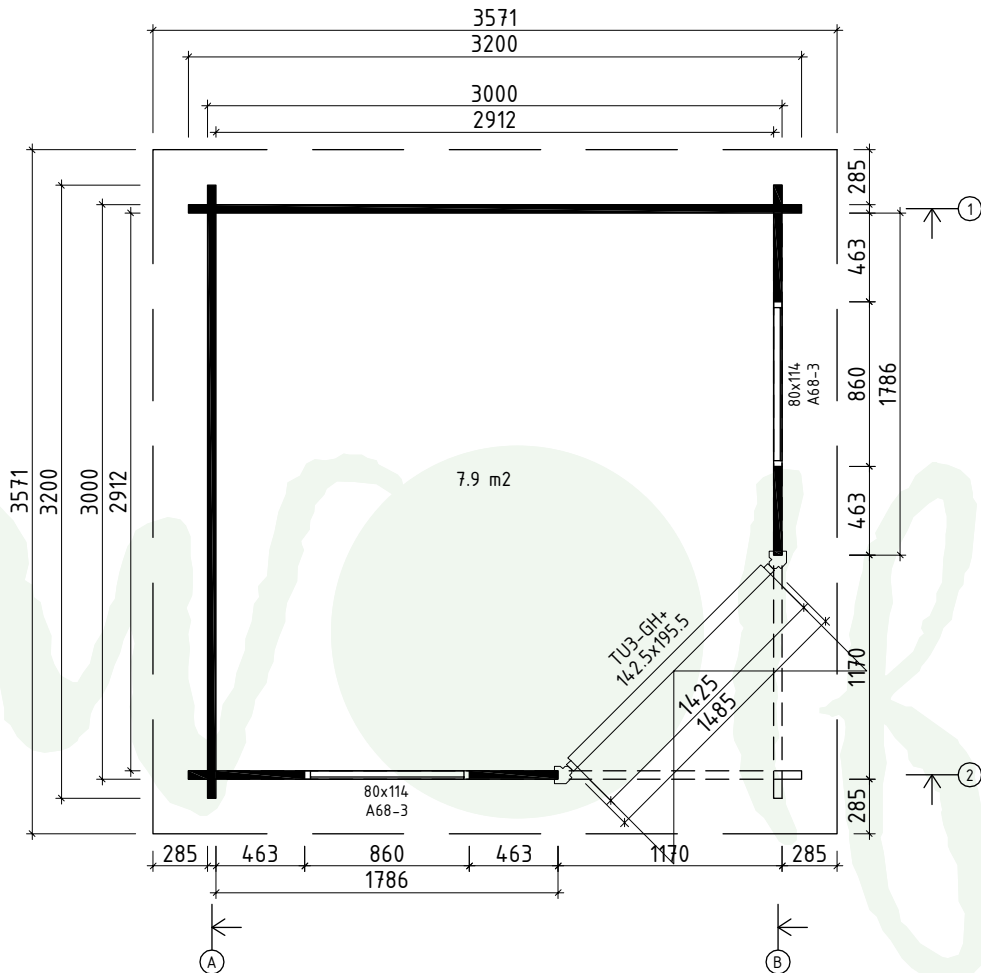

# Lagerholzplan und Fundamentplan Maria 44-A

Wir empfehlen als Fundament für Ihr Gartenhaus eine vollflächig festgegründete, gepflasterte oder betonierte Fläche.  
Wahlweise ist auch ein Punkt- oder Streifenfundament möglich.

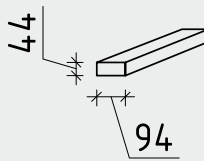
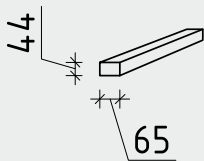
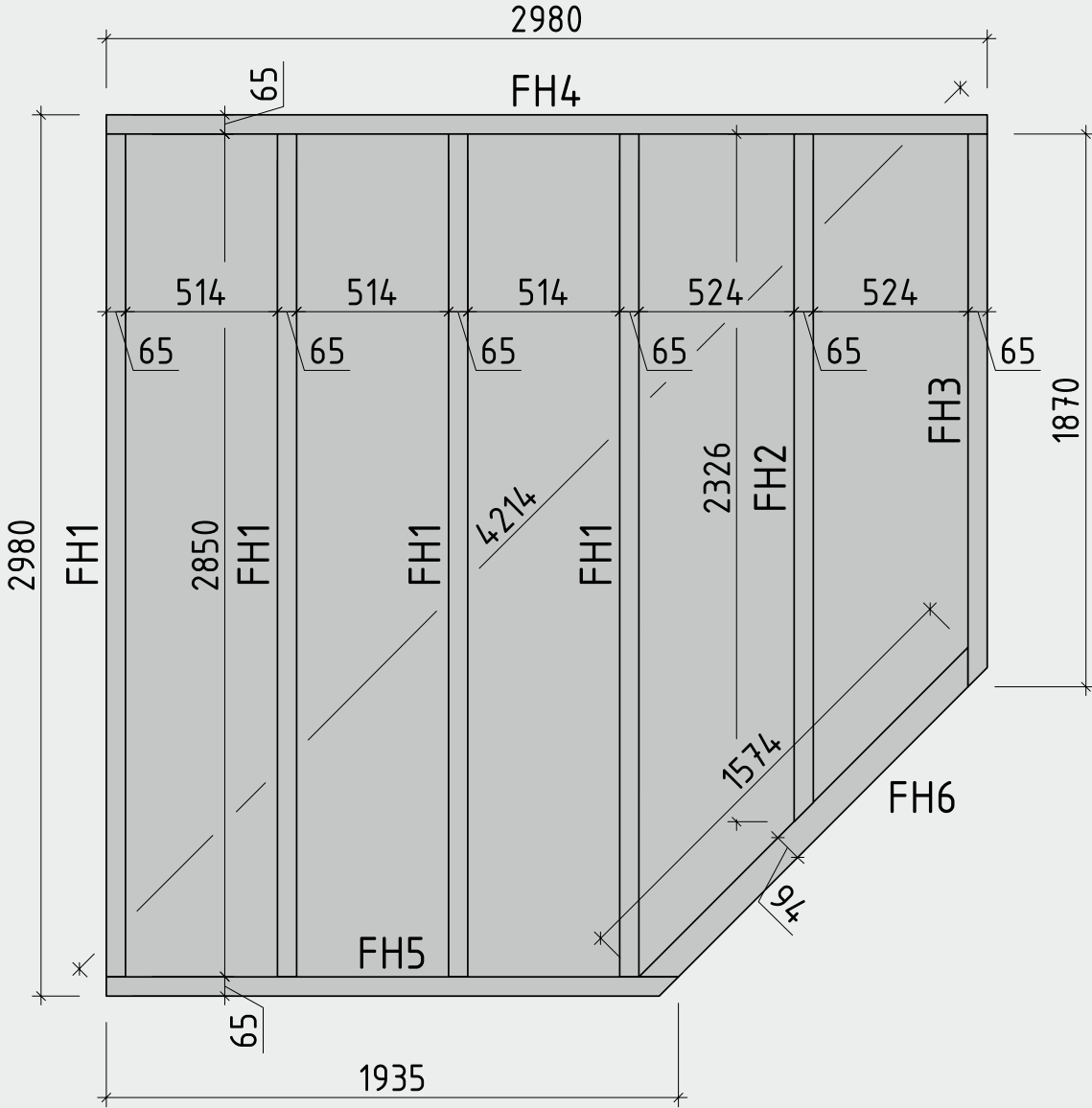



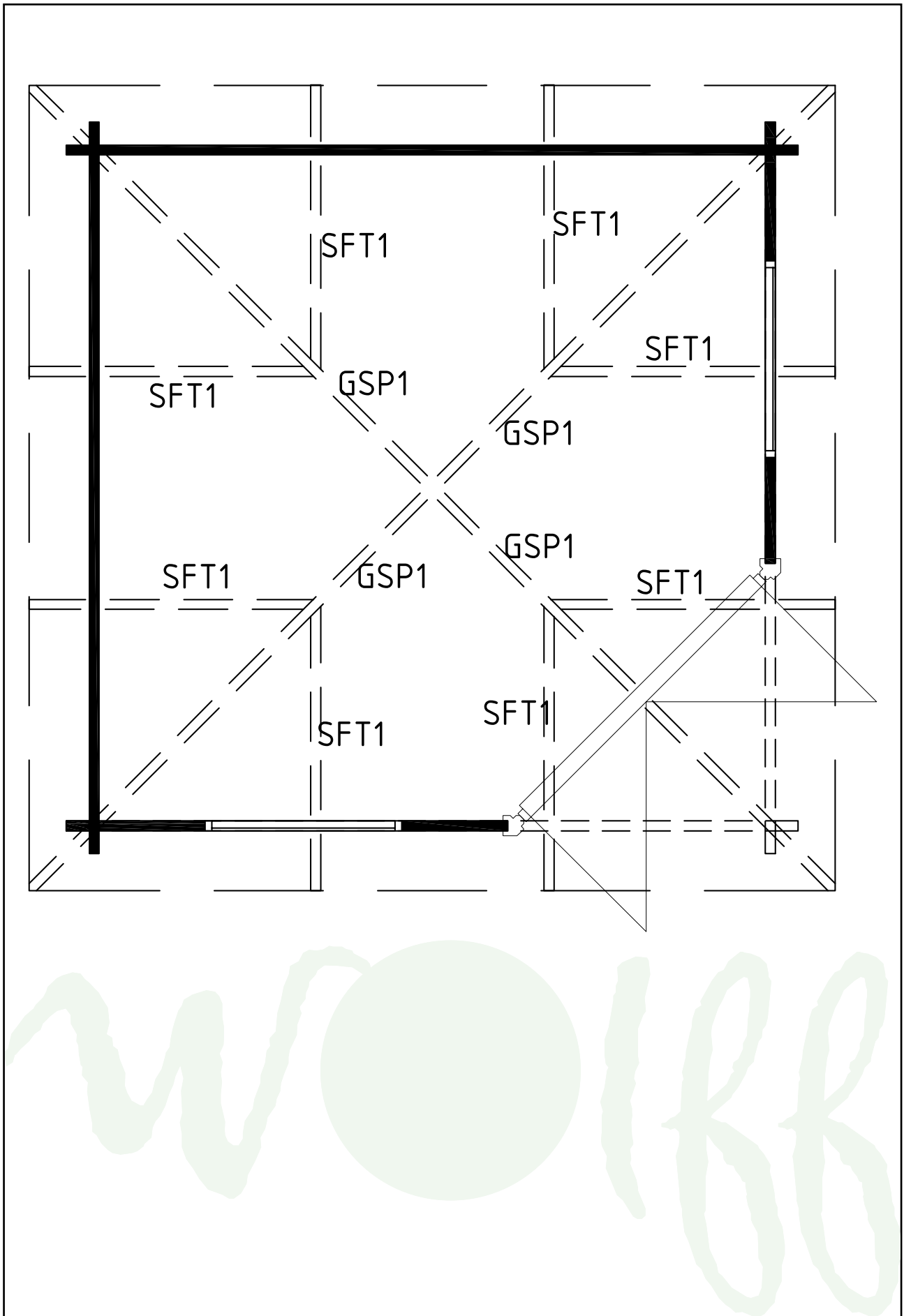



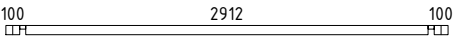
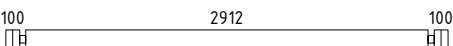
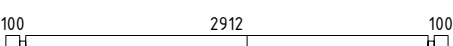
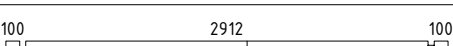
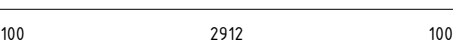
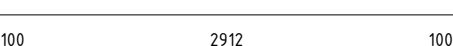
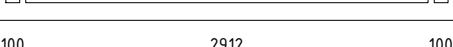
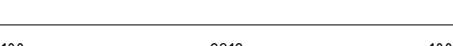
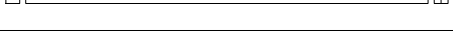
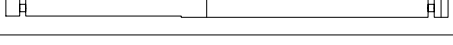
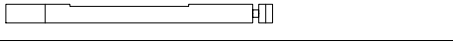
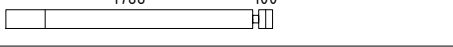
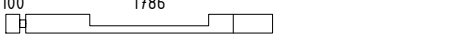
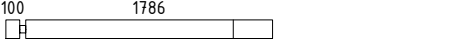
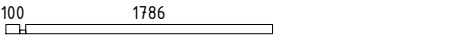

# Pfettenplan Maria 44-A







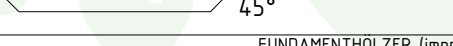
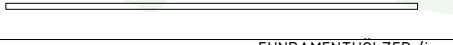



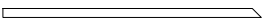

# Teileliste 1

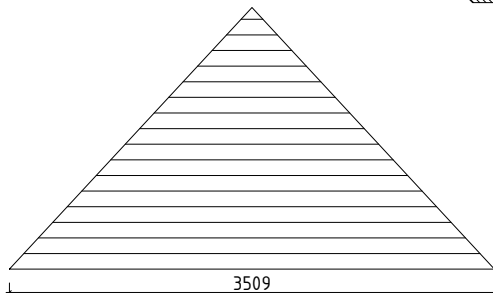
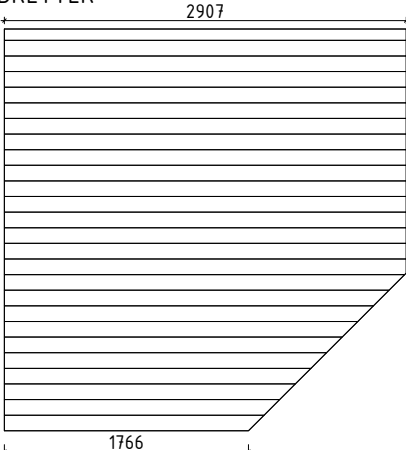
## Maria 44-A

Pos		Stck	Profil (mm)	Länge (mm)
001		1	44x68	3200
002		16	44x135	3200
003		1	44x135	3200
004		1	44x135	3200
005		1	44x135	3200
006		15	44x135	3200
007		1	44x68	3200
008		1	44x68	3200
009		1	44x135	3200
010		1	44x135	1930
011		5	44x135	1930
012		1	44x135	1930
013		5	44x135	1930
014		1	44x68	1930
015		4	44x74	960
016		4+4	44x74	945
017		9	44x135	607
018		8	44x135	607
019		2	44x135	463
020		4	44x135	463
021		11	44x135	463
FH6		1	94x44	1574
FH4		1	65x44	2980
FH1		4	65x44	2850
FH2		1	65x44	2326

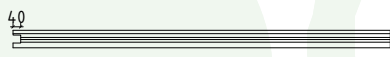
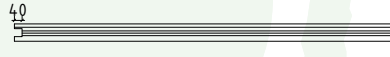





# Teileliste 2

## Maria 44-A

Pos		Stck	Profil (mm)	Länge (mm)	
FH5	FUNDAMENTHÖLZER (imprägniert)  45°	1	65x44	1935	
FH3	FUNDAMENTHÖLZER (imprägniert)  45°	1	65x44	1870	
GSP1	GRATSPARREN 	4	44x94	2571	
SFT1	SCHIFTER 	4+4	44x85	1366	
	DACHBRETTER 	4	113x18		
	FUSSBODENBRETTER 	1	113x18	15+1 singed/ ohne Ecke  11 nurk 45°/ mit Ecke	
	FUSSBODENLEISTE 	✓	18x40	11,0 lfm	
T1-1	TRAUFENBRETTER 120X18 	✓	4	120x18	3610
	Zentralverbindungselement (Dach) 	1	44x44	90	
P9L-1	ECKTÜR- linke Türpfoste 90 	1	90x90	2045	
P9R-1	ECKTÜR- rechte Türpfoste 90 	1	90x90	2045	
DzT 40-1	ECKTÜR- Deckbrett zum Tür 40 	1	18x40	1585	
VK-1	ECKTÜR- Verkleidungsleisten für Vordachelement 	✓	2	58x12	1110
VE1	ECKTÜR- Vordachelement 1435x745 	1			
SH	Schlaghölzer 	3			

# Teileliste 3

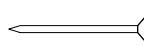
## Maria 44-A

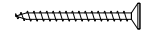
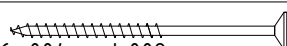
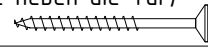
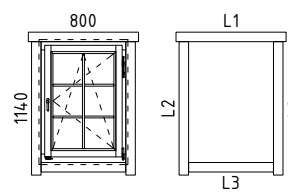
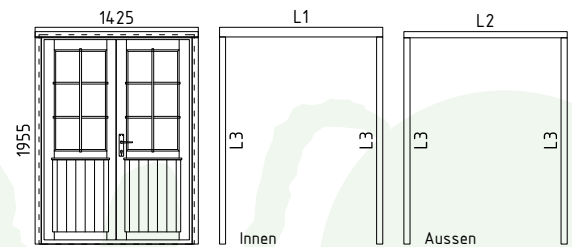
Pos			Stck	Profil (mm)	Länge (mm)
ML1	Metallstange		4	D10	1170
KL1	Gewindestange M8		3	M8	2000
KL2	Gewindestange M8		3	M8	258
	Mutter M8 U-Scheibe Ø25		6	M8	
	Befestigungsmutter M8		3	M8	
NG1	NÄGEL 2.5x50	Dachbretter Fussbodenbretter		760	
SR01	SCHRAUBEN 3.0x30	Fussbodenleiste		25	
SR03	SCHRAUBEN 3.5x45	Deckbrett, Vordachelement Verkleidungsleisten, Traufenbretter Fenster- und Türleisten		118	
SR10	SCHRAUBEN 5.0x100	Fundamenthölzer Wandbalken pos 015, 016, 004 und 008		68	
SR09	SCHRAUBEN 5.0x70	pos 011 und 014 (1. Bohlenreihe neben die Tür) Pfetten PF1, PF2		24	
	FENSTER 800x1140		2		
	 <p style="text-align: center;">A68-3</p> <p>L1 18x90 L=1040mm 2 Stck. L2 18x90 L=1260mm 4 Stck. L3 18x90 L=800mm 2 Stck. ✓</p> <p>DIN 1xrechts/1links</p>				
	TÜR 1425x1955		1		
	 <p style="text-align: center;">TU3-GH+</p> <p>L1 18x90 L=1540mm 1 Stck. L2 18x58 L=1540mm 1 Stck. L3 18x58 L=1955mm 4 Stck. ✓</p> <p>DIN rechts</p>				
	✓ - bitte selber anpassen (falls nötig)!				

# Wandplan 1 und 2 Maria 44-A

