

Technische Daten Trondheim 44-A XL

Wandaußenmaß: 360 x 300 cm

Bohlenstärke: 44 mm



Kontrolliert durch:

Achtung: Alle angegebenen Maße sind ca.-Maße!

3D-Darstellung und Grundriss Trondheim 44-A XL

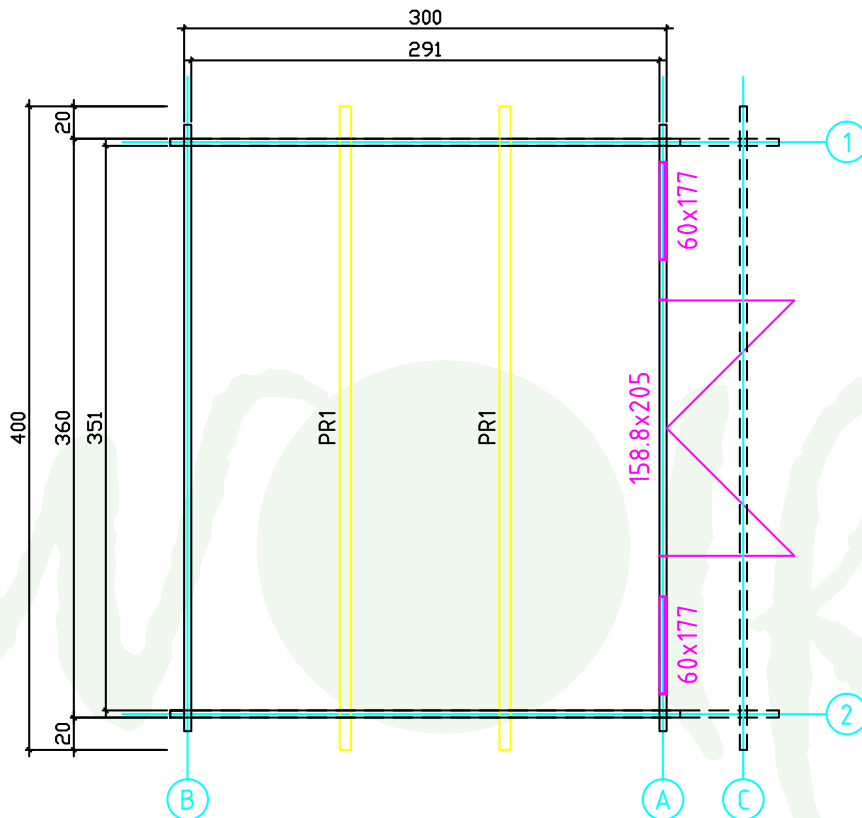
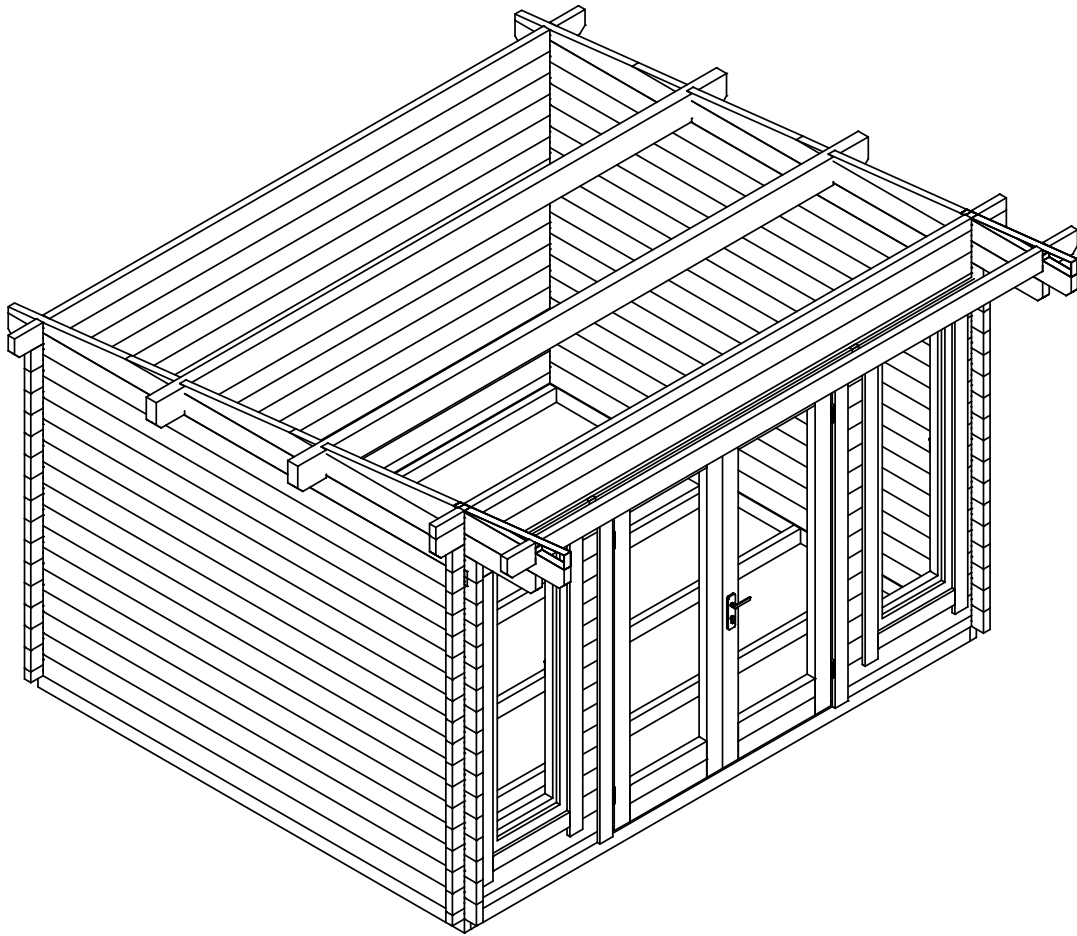





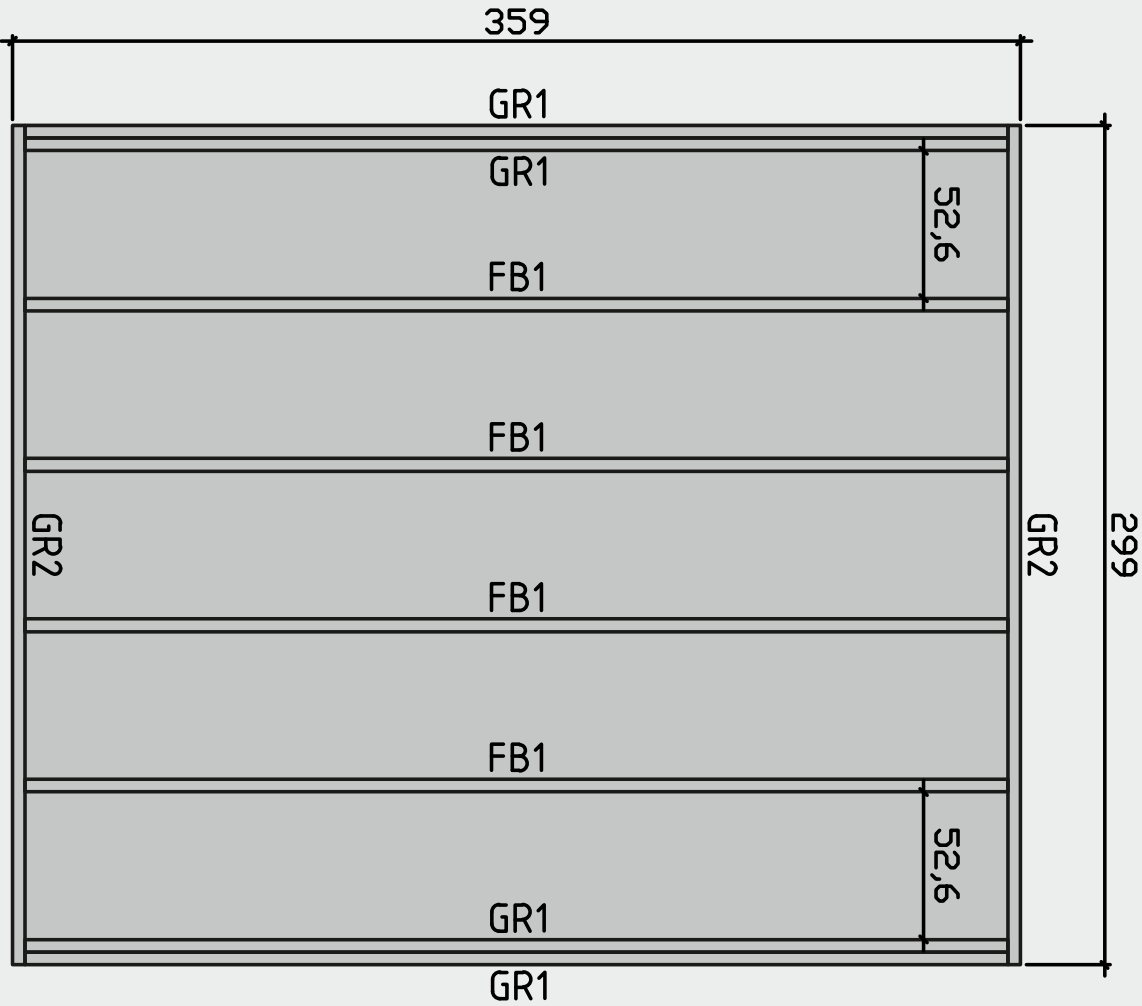





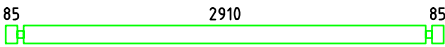
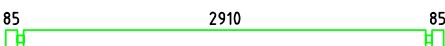

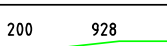
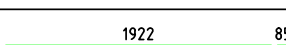

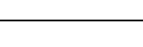
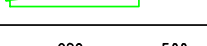
Lagerholzplan und Fundamentplan Trondheim 44-A XL

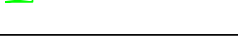
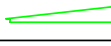
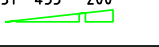
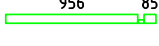
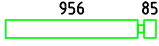
Wir empfehlen als Fundament für Ihr Gartenhaus eine vollflächig festgegründete, gepflasterte oder betonierte Fläche.
Wahlweise ist auch ein Punkt- oder Streifenfundament möglich.

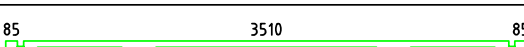
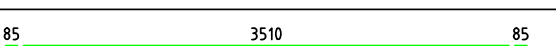
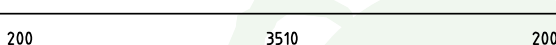

Teileliste 1

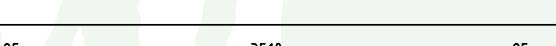
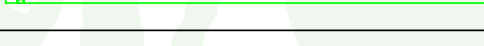
Trondheim 44-A XL

Pos		Quantity	Profil (mm)	Lenght (mm)
001		2	45x130	3170
002		28	45x130	3170
003		2	45x130	3285
004		2	45x130	1173
005		2	45x130	2052
006		2	45x40	352
007		2	45x130	963
008		2	45x130	1473
009		2	45x22	194
010		2	45x130	1703
011		2	45x88	776
012		2	45x65	1086
013		2	45x130	1086
014		2	45x130	1086
015		26	45x130	230
016		26	45x130	246
017		1	45x130	3770
018		16	45x130	3770
019		1	45x130	4000
020		1	45x74	4000
021		1	45x65	3770
022		2	45x130	4000
GR1	GROUNDFRAME 	4	45x90	3500
GR2	GROUNDFRAME 	2	45x90	2990
FB1	FLOORBEAMS 	4	45x90	3500

Teileliste 3

Trondheim 44-A XL

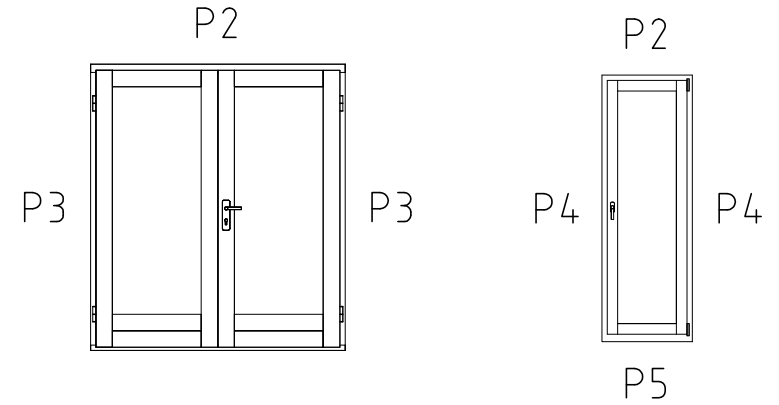
POS	ST.	B	H	L	Teileliste
FB1	Vt. spetsi				FUNDMENTHOLZER
F1	10,2m ²	28		2905	FUSSBODENBRETTER
PR	2	70	170	4000	DACHBALKEN
RB1	15,7m ²	20		3925	DACHBRETTER
R1	2	20	140	4040	<small>Vaata keti se kalteni rka</small> Traufenbretter
R2	2	45	65	4000	<small>Vaata keti se kalteni rka</small> Traufenbretter
R3	2	20	140	4120	<small>Vaata keti se kalteni rka</small> Giebelabschlussleiste
R4	2	20	90	4120	Giebelabschlussleiste
DR1 WN1	1 2	1588 600	2050 1770		
P1	14m	20	40		Fußbodenleiste
P2	1+1	20	90	3500	Türleiste DR1, Fensterleiste WN1
P3	2+2	20	90	2030	Türleiste DR1
P4	4+4	20	90	1920	Fensterleiste WN1
P5	2+2	20	90	540 570	Fensterleiste WN1



Wandplan 1 und 2 Trondheim 44-A XL

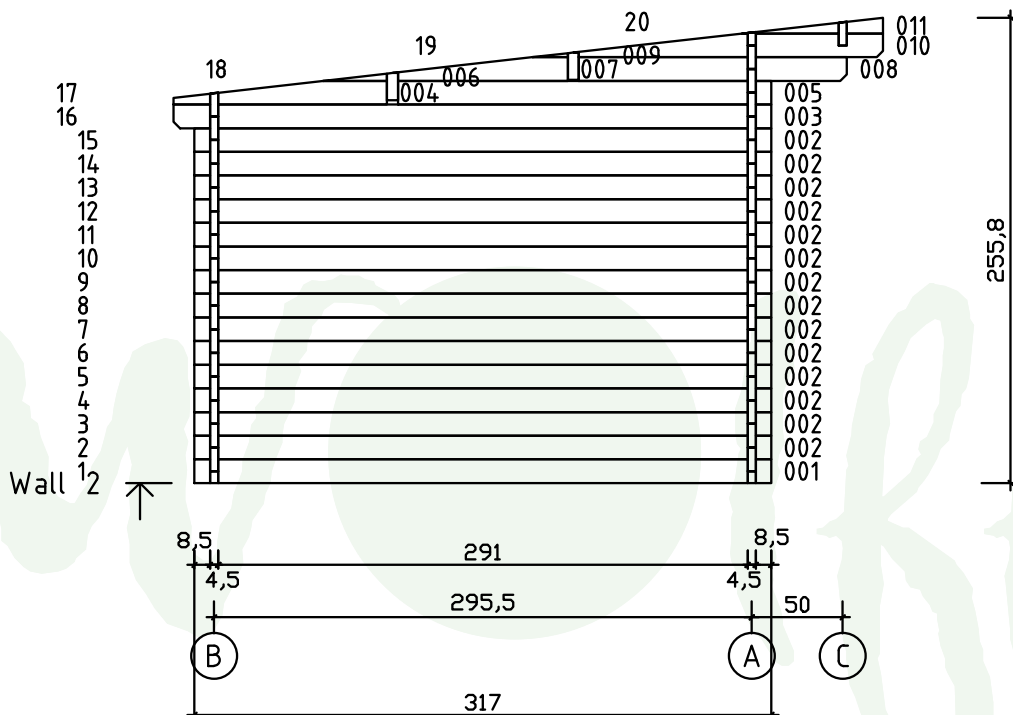
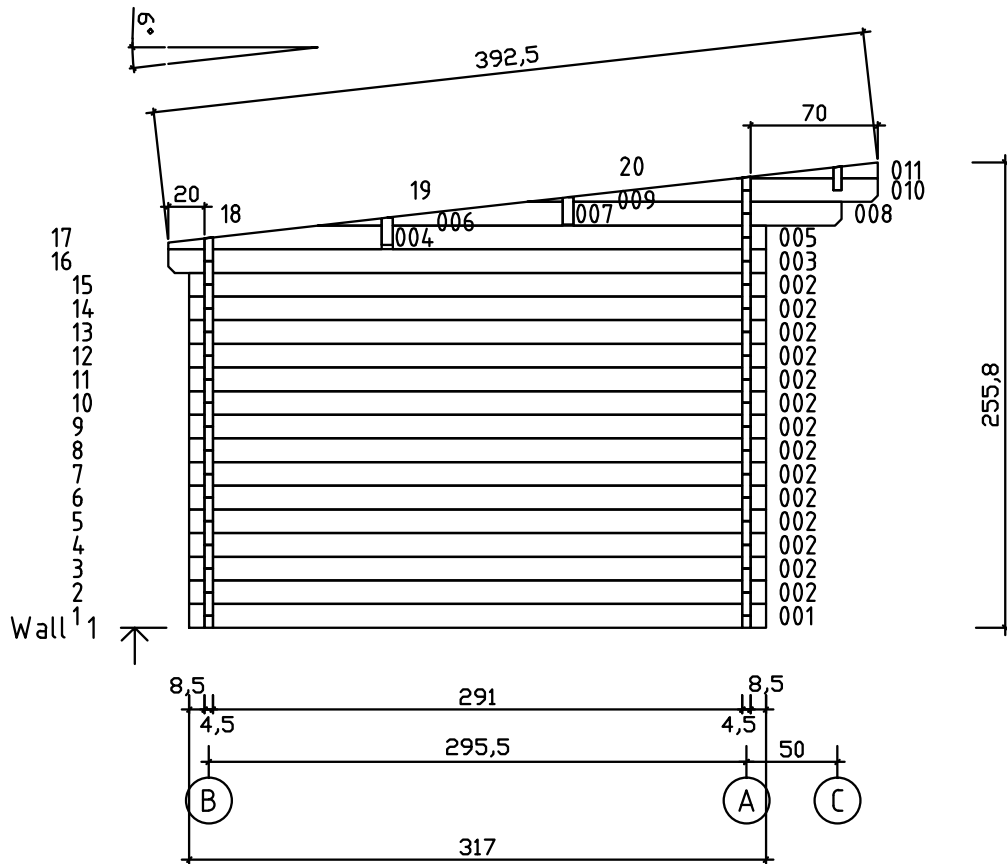

Wandplan A und B Trondheim 44-A XL

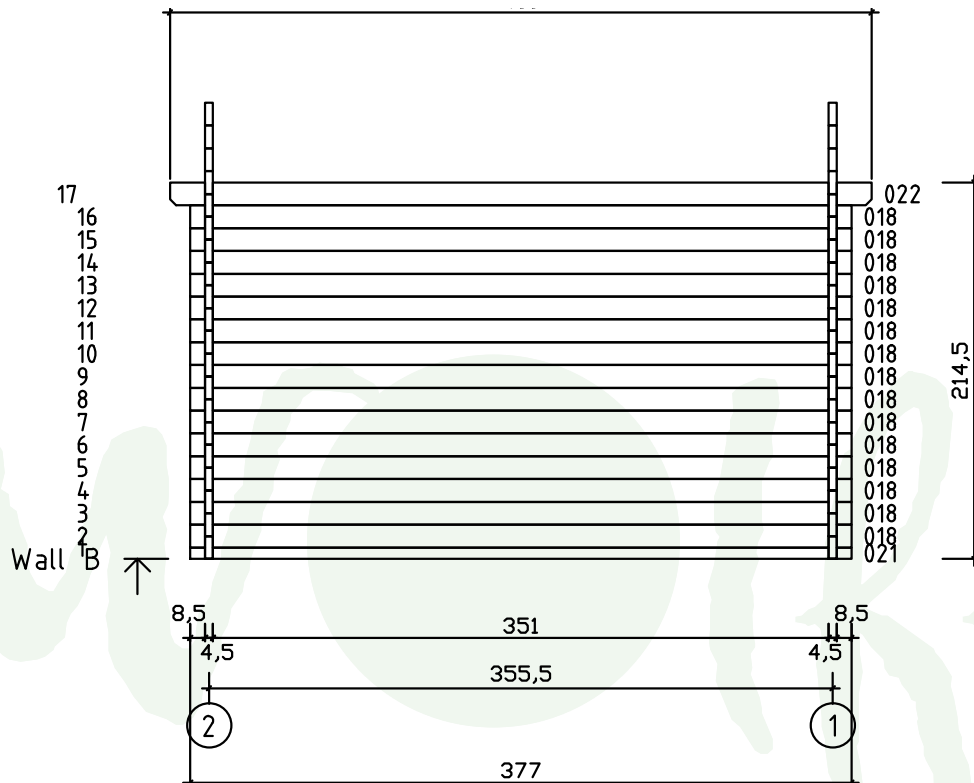
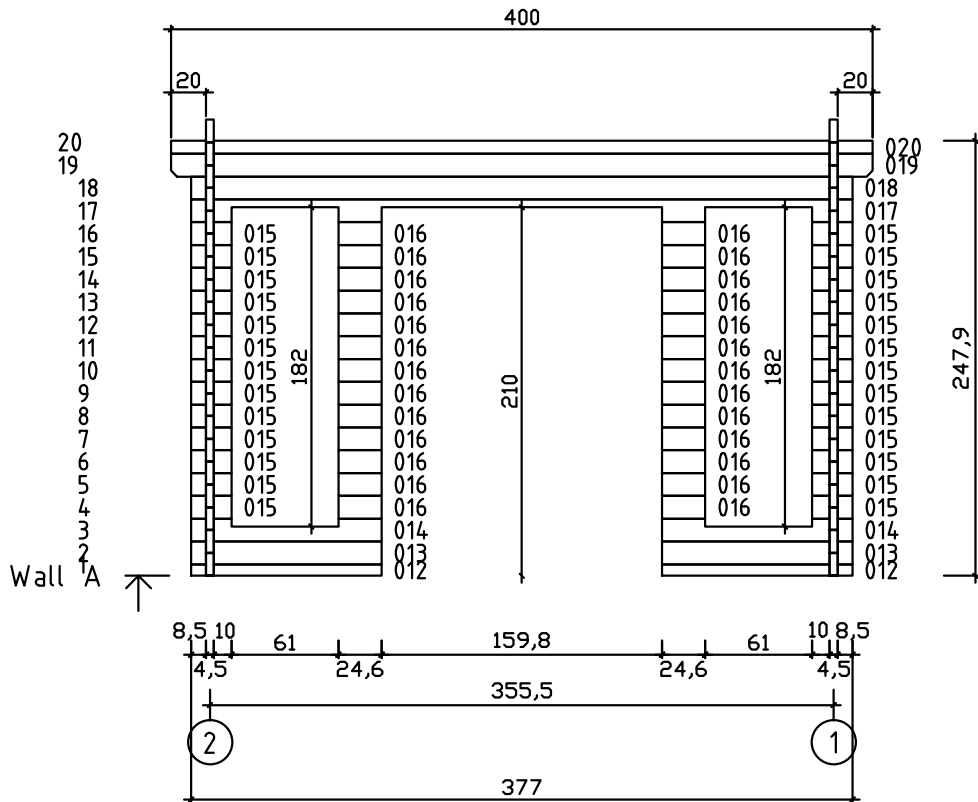

Wandplan C Trondheim 44-A XL

