

# Technische Daten Trondheim 44-B XL

Wandaußenmaß: 360 x 360 cm

Bohlenstärke: 44 mm



Kontrolliert durch:

Achtung: Alle angegebenen Maße sind ca.-Maße!

# 3D-Darstellung und Grundriss Trondheim 44-B XL

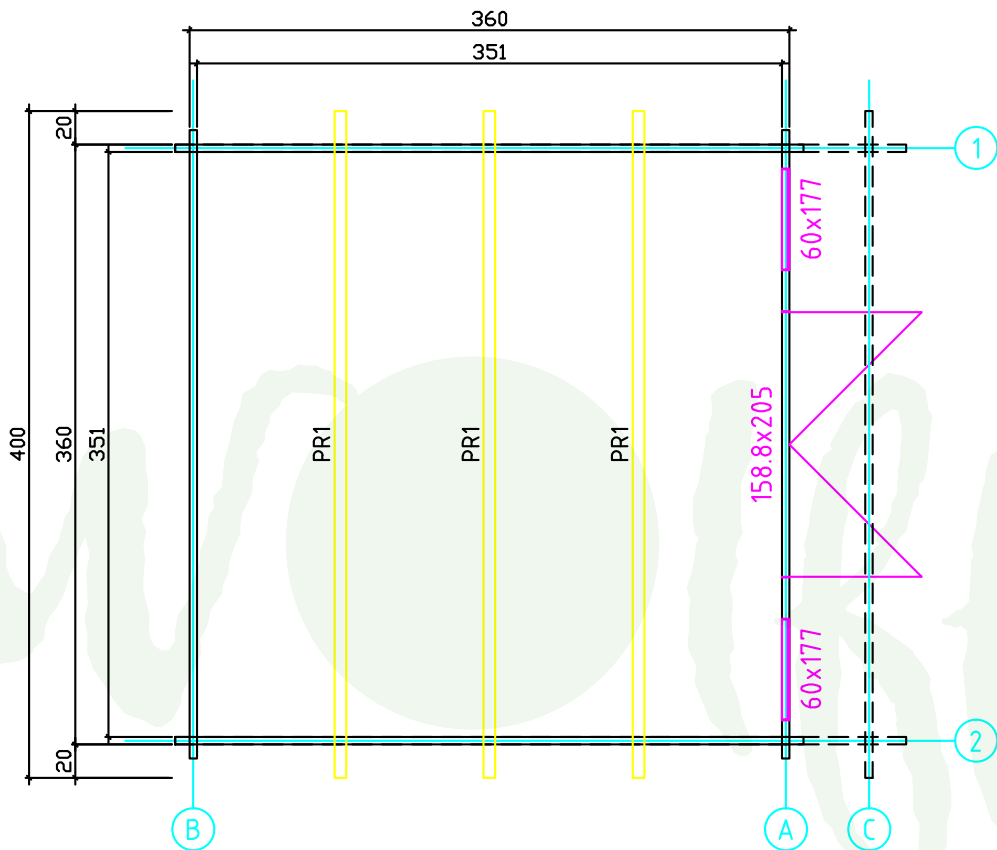
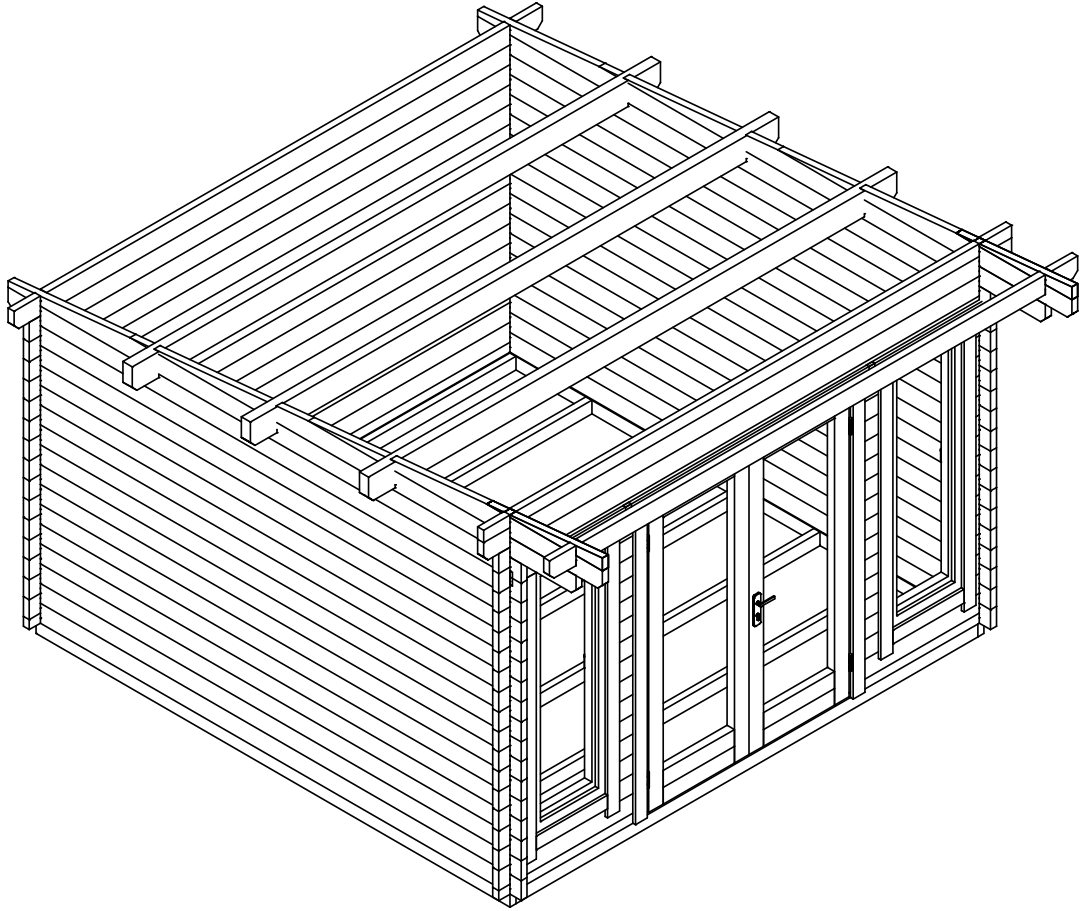



# Teileliste 1

## Trondheim 44-B XL

Pos	Quantity	Profil (mm)	Lenght (mm)
001	2	45x130	3770
002	44	45x130	3770
003	2	45x130	3885
004	2	45x130	1075
005	2	45x130	2750
006	2	45x15	154
007	2	45x101	865
008	2	45x130	2270
009	2	45x57	593
010	2	45x130	1605
011	2	45x84	876
012	2	45x65	1086
013	2	45x130	1086
014	2	45x130	1086
015	26	45x130	230
016	26	45x130	246
017	1	45x130	3770
018	1	45x130	4000
019	1	45x82	4000
020	1	45x65	3770
021	2	45x130	4000
GR2	2	45x90	3590
GR1	4	45x90	3500
FB1	5	45x90	3500
PR1	3	70x170	4000



# Teileliste 3

## Trondheim 44-B XL

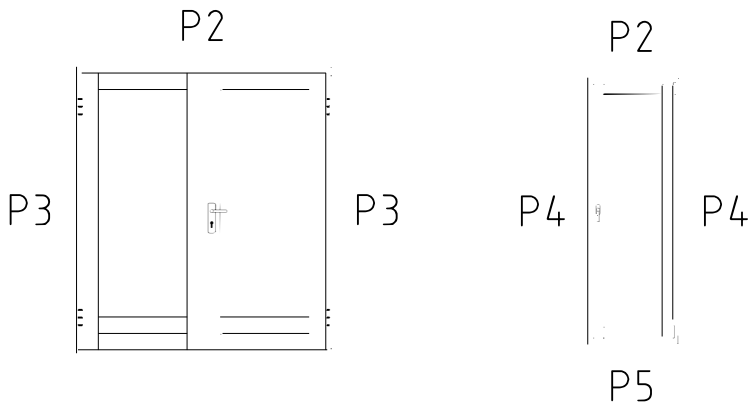
POS	ST.	B	H	L	
FB1	Vt. spetsi				FUNDMENTHOLZER
F1	12,3m <sup>2</sup>	28		3505	FUSSBODENBRETT
PR	3	70	170	4000	DACHBALKEN
RB1	18,1m <sup>2</sup>	20		4521	DACHBRETT
*R1	2	20	140	4040	Traufenbretter
*R2	2	45	45	4000	Traufenbretter
*R3	2	20	140	4720	Giebelabschlussleiste
*R4	2	20	90	4720	Giebelabschlussleiste
DR1 WN1	1 2	1588 600	2050 1770		
*P1	15m	20	40		Fußbodenleiste
*P2	1+1	20	90	3500	Türleiste DR1, Fensterleiste WN1
*P3	2+2	20	90	2030	Türleiste DR1
*P4	4+4	20	90	1920	Fensterleiste WN1
*P5	2+2	20	90	<del>540</del> 570	Fensterleiste WN1

\*Wird als Fixlänge geliefert und muss bauseits zugeschnitten werden.

# Wandplan 1 und 2 Trondheim 44-B XL

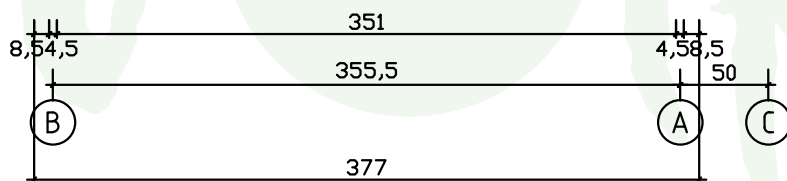
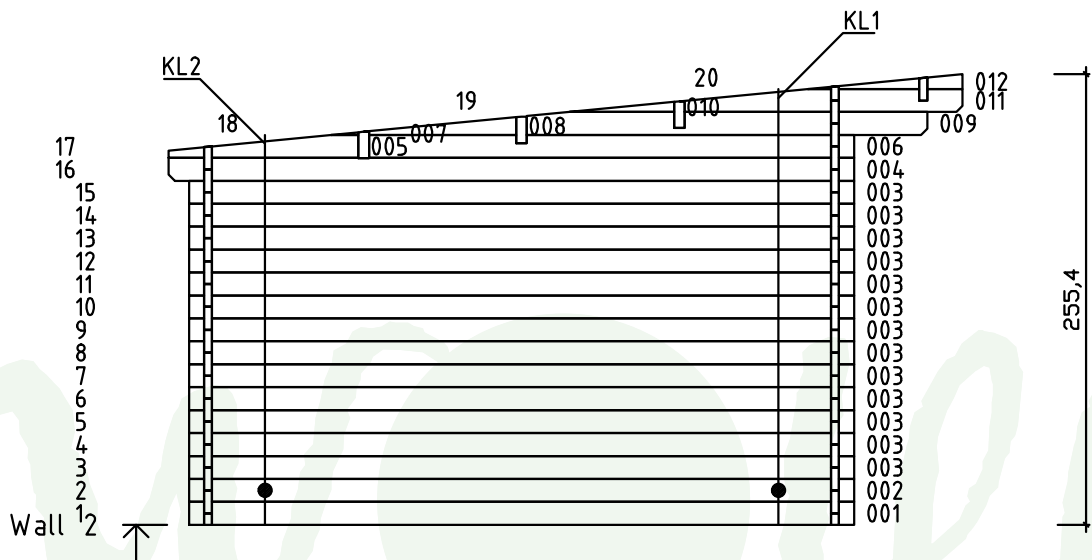
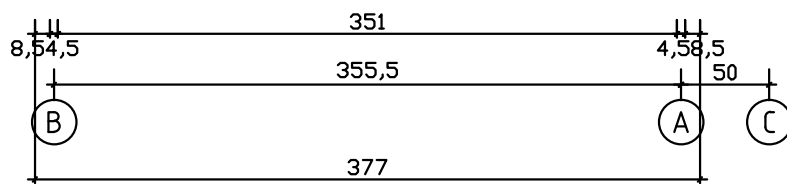
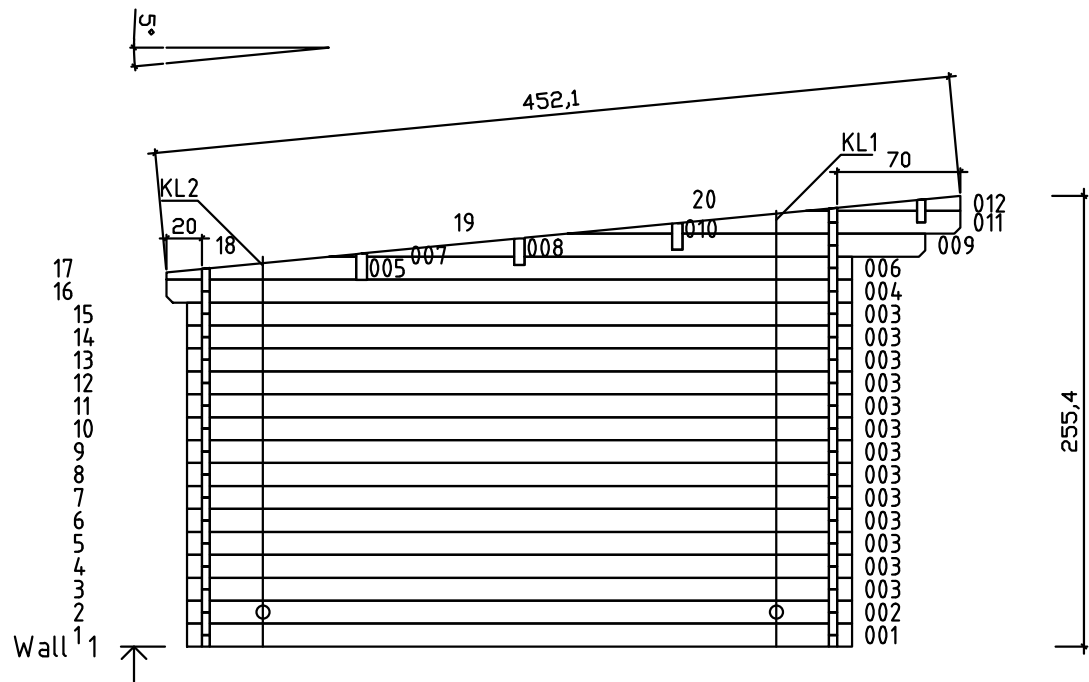

# Wandplan A und B Trondheim 44-B XL

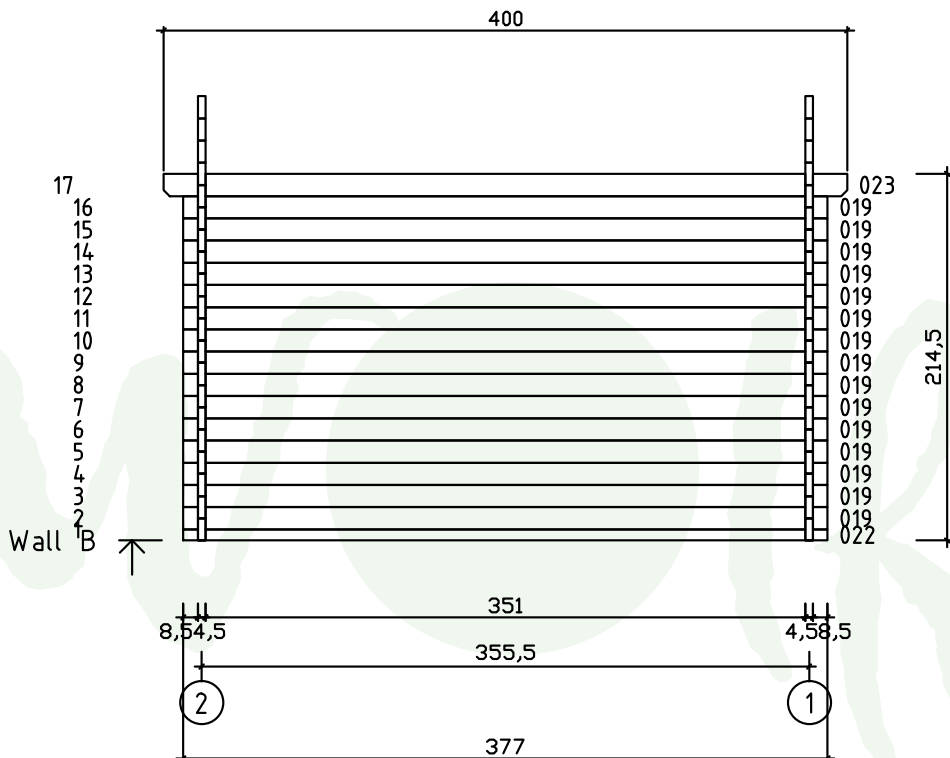
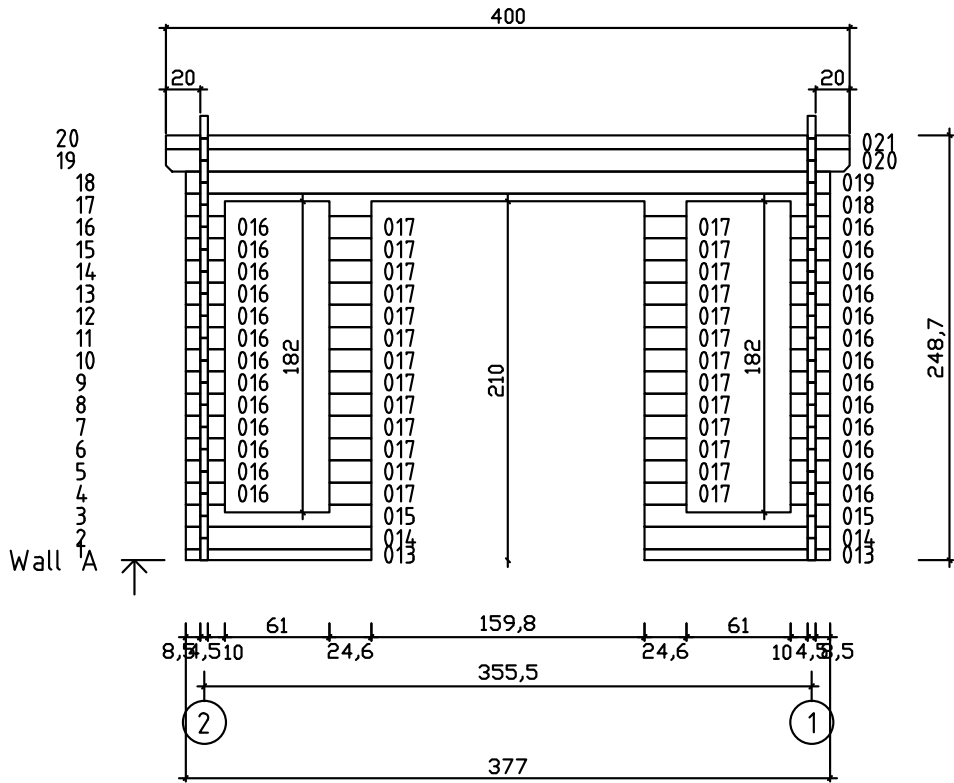



# Wandplan C Trondheim 44-B XL

## Vorgelagerte Vordachbohle vor Wand A

