

# Technische Daten Trondheim 44-C XL

Wandaußenmaß: 390 x 390 cm

Bohlenstärke: 44 mm



Trondheim 70-D XL

Kontrolliert durch:

Achtung: Alle angegebenen Maße sind ca.-Maße!

# 3D-Darstellung und Grundriss Trondheim 44-C XL

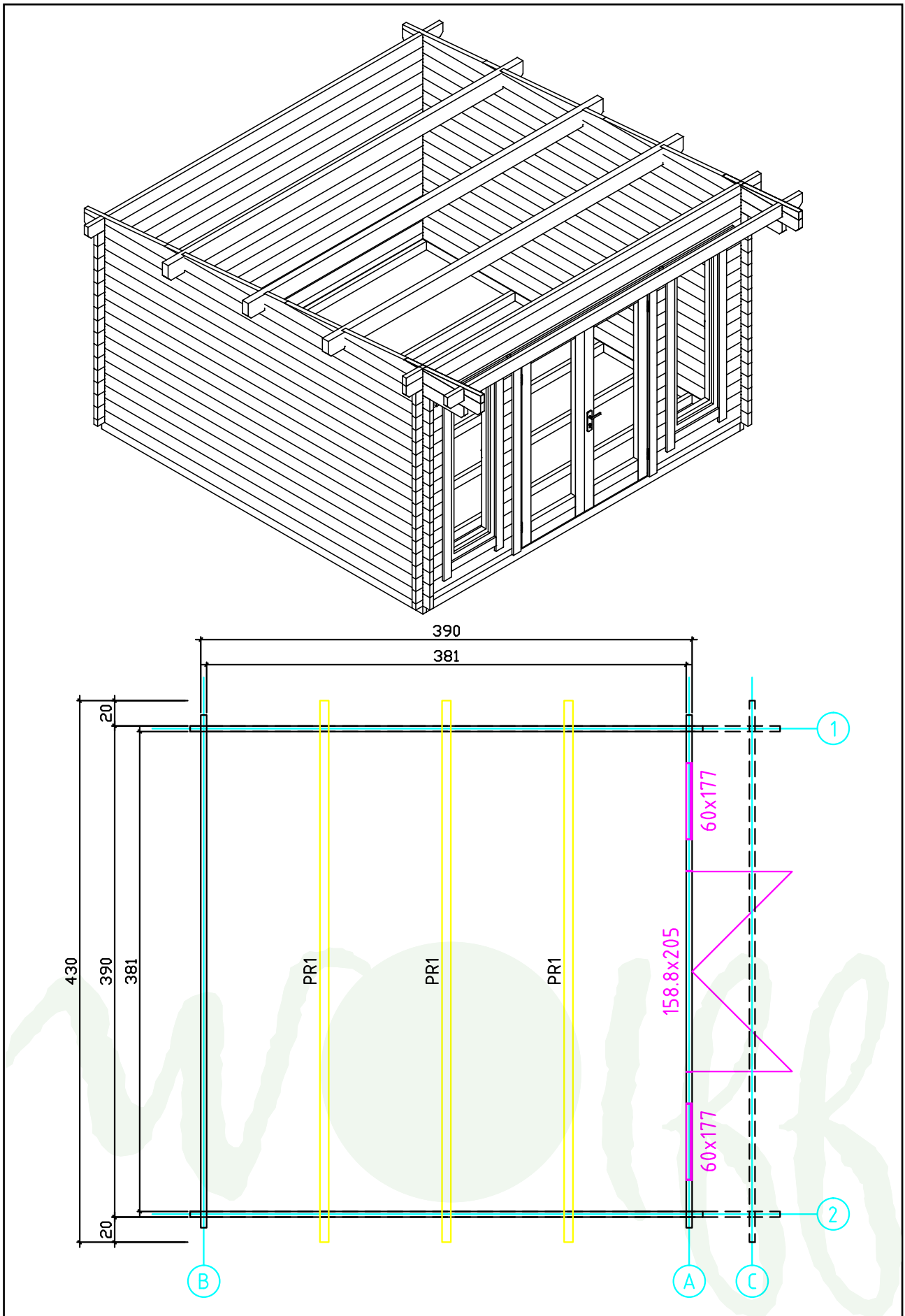





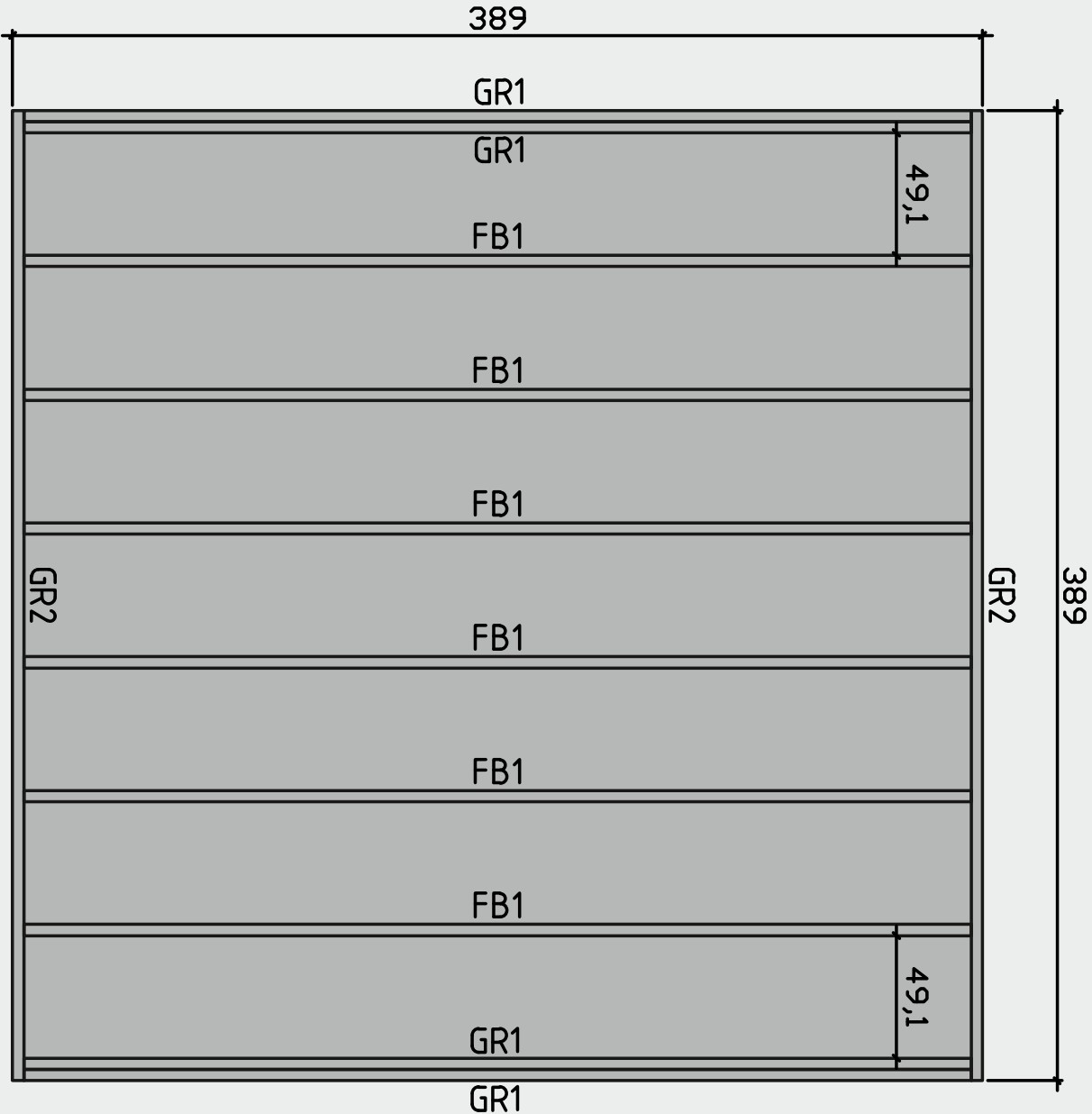





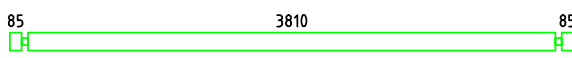
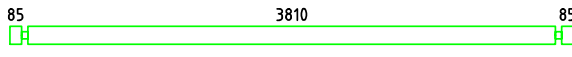
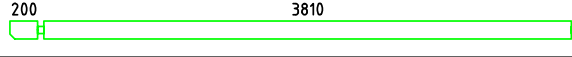
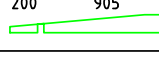
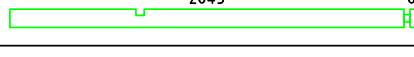

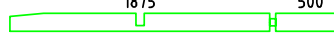
# Lagerholzplan und Fundamentplan Trondheim 44-C XL

Wir empfehlen als Fundament für Ihr Gartenhaus eine vollflächig festgegründete, gepflasterte oder betonierte Fläche.  
Wahlweise ist auch ein Punkt- oder Streifenfundament möglich.

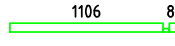
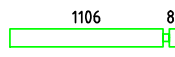
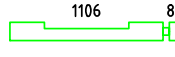

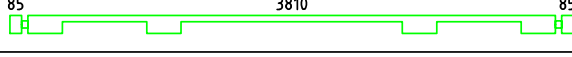
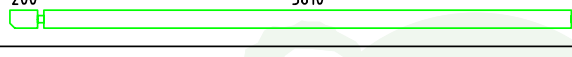
# Teileliste 1

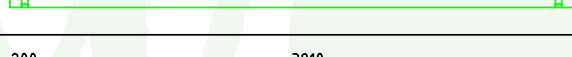
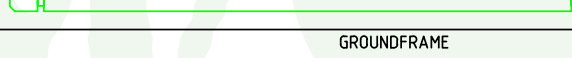
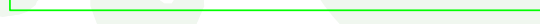
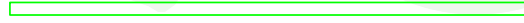
## Trondheim 44-C XL

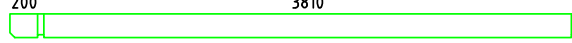
Pos		Quantity	Profil (mm)	Lenght (mm)
001		2	45x130	4070
002		44	45x130	4070
003		2	45x130	4185
004		2	45x130	1150
005		2	45x130	2975
006		2	45x16	179
007		2	45x103	940
008		2	45x130	2420
009		2	45x60	668
010		2	45x130	1680
011		2	45x83	926
012		2	45x65	1236
013		2	45x130	1236
014		2	45x130	1236
015		26	45x130	378
016		26	45x130	248
017		1	45x130	4070
018		1	45x130	4300
019		1	45x85	4300
020		1	45x65	4070
021		2	45x130	4300
GR2	GROUNDFRAME 	2	45x90	3890
GR1	GROUNDFRAME 	4	45x90	3800
FB1	FLOORBEAMS 	6	45x90	3800
PR1	Purlins 	3	70x170	4300

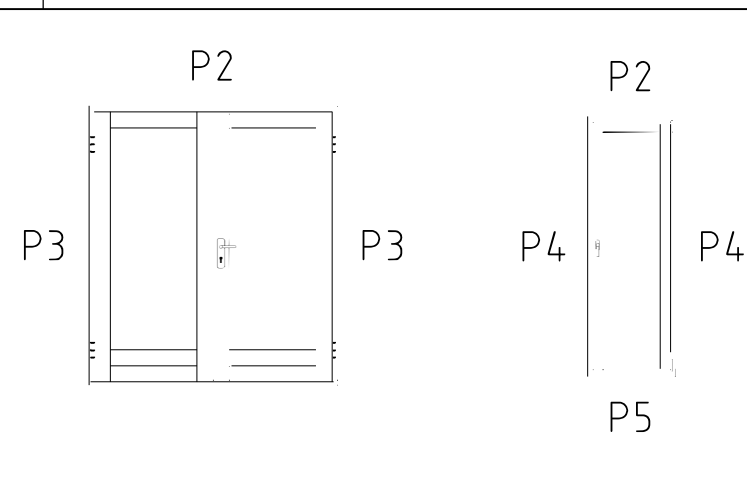

# Teileliste 3 Trondheim 44-C XL

POS	ST.	B	H	L	Teileliste
FB1	Vt. spetsi				FUNDMENTHOLZER
F1	14,5m <sup>2</sup>	28		3805	FUSSBODENBRETTER
PR	3	70	170	4300	DACHBALKEN
RB1	20,7m <sup>2</sup>	20		4819	DACHBRETTER
*R1	2	20	140	4340	Vaata katuse kaldeuurka  Traufenbretter
*R2	2	45	45	4300	Vaata katuse kaldeuurka  Traufenbretter
*R3	2	20	140	5020	Vaata katuse kaldeuurka  Giebelabschlussleiste
*R4	2	20	90	5020	Giebelabschlussleiste
DR1 WN1	1 2	1588 600	2050 1770		
*P1	17m	20	40		Fußbodenleiste
*P2	1+1	20	90	3800	Türleiste DR1, Fensterleiste WN1
*P3	2+2	20	90	2030	Türleiste DR1
*P4	4+4	20	90	1920	Fensterleiste WN1
P5	2+2	20	90	<del>540</del> 570	Fensterleiste WN1

\*Wird als Fixlänge geliefert und muss bauseits zugeschnitten werden.

# Wandplan 1 und 2 Trondheim 44-C XL

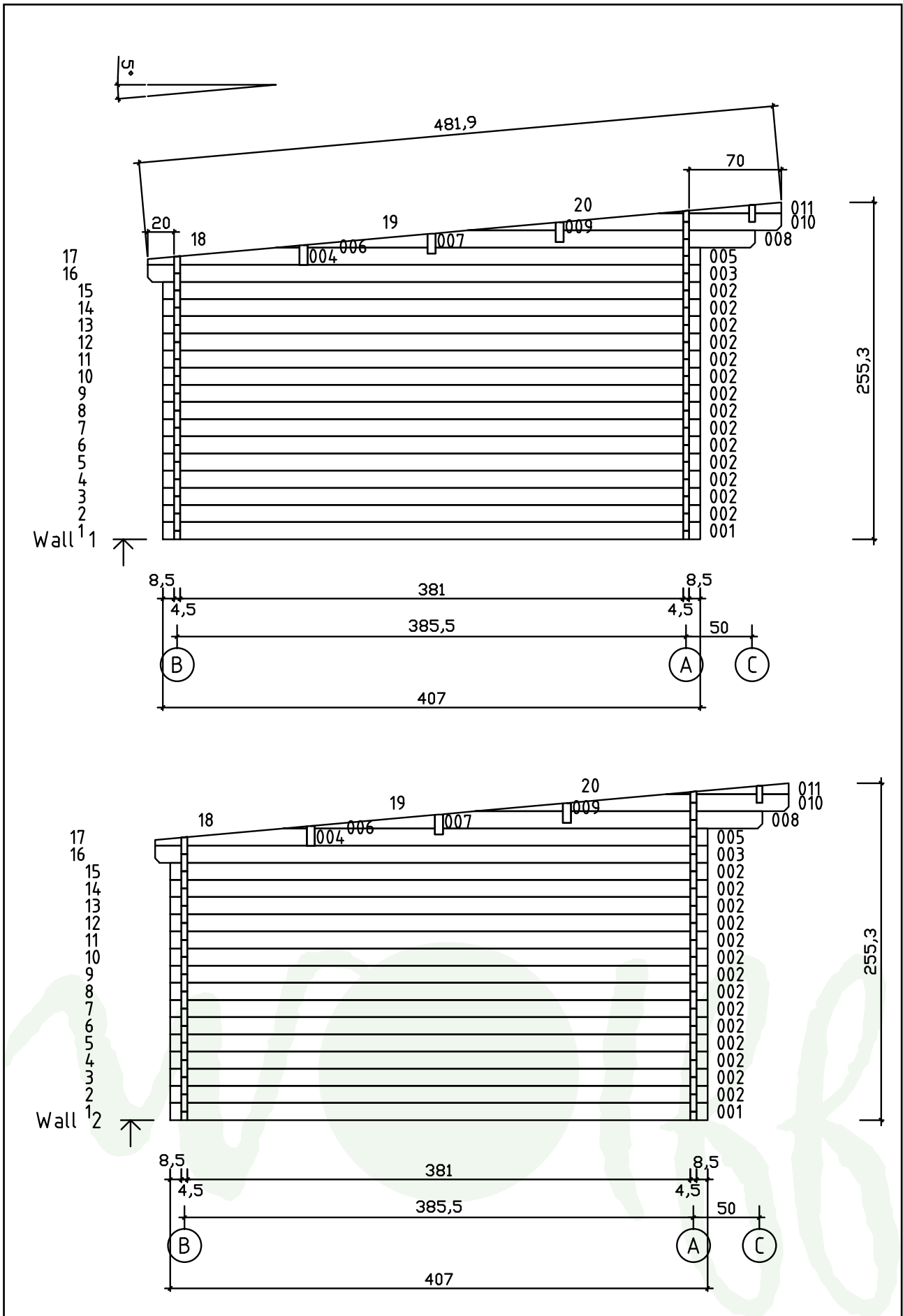

# Wandplan A und B Trondheim 44-C XL

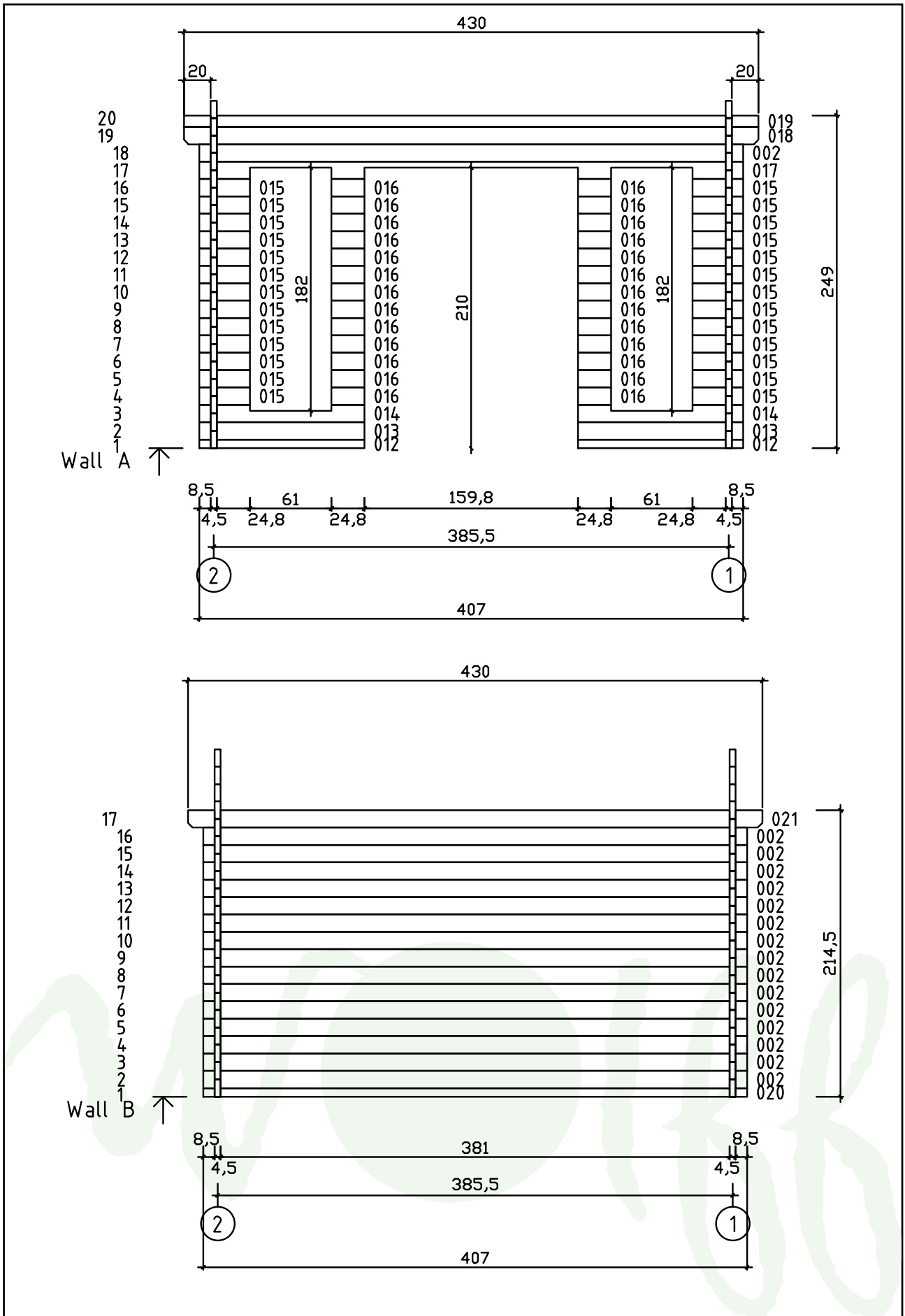



# Wandplan C

## Trondheim 44-C XL

### Vorgelagerte Vordachbohle vor Wand A

