

**Technische Daten: Art.-Nr.: 845120**

**Wandaußenmaß: 540 x 390 cm**

**Bohlenstärke: 44 mm**



Cordoba 44-B Modern

Kontrolliert durch:

Empty box for signature or name.

Achtung: Alle angegebenen Maße sind ca.-Maße!

# 3D-Darstellung und Grundriss Korpus für 845120

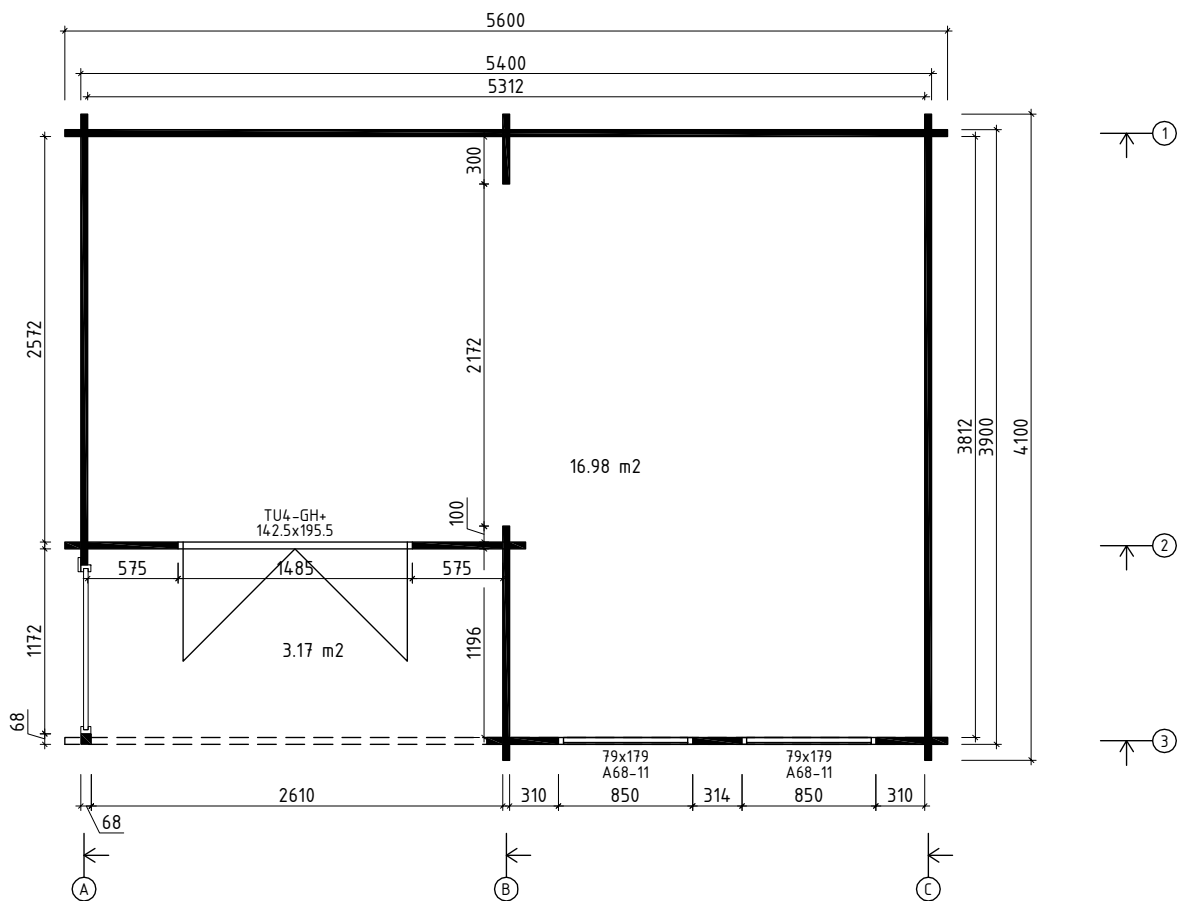
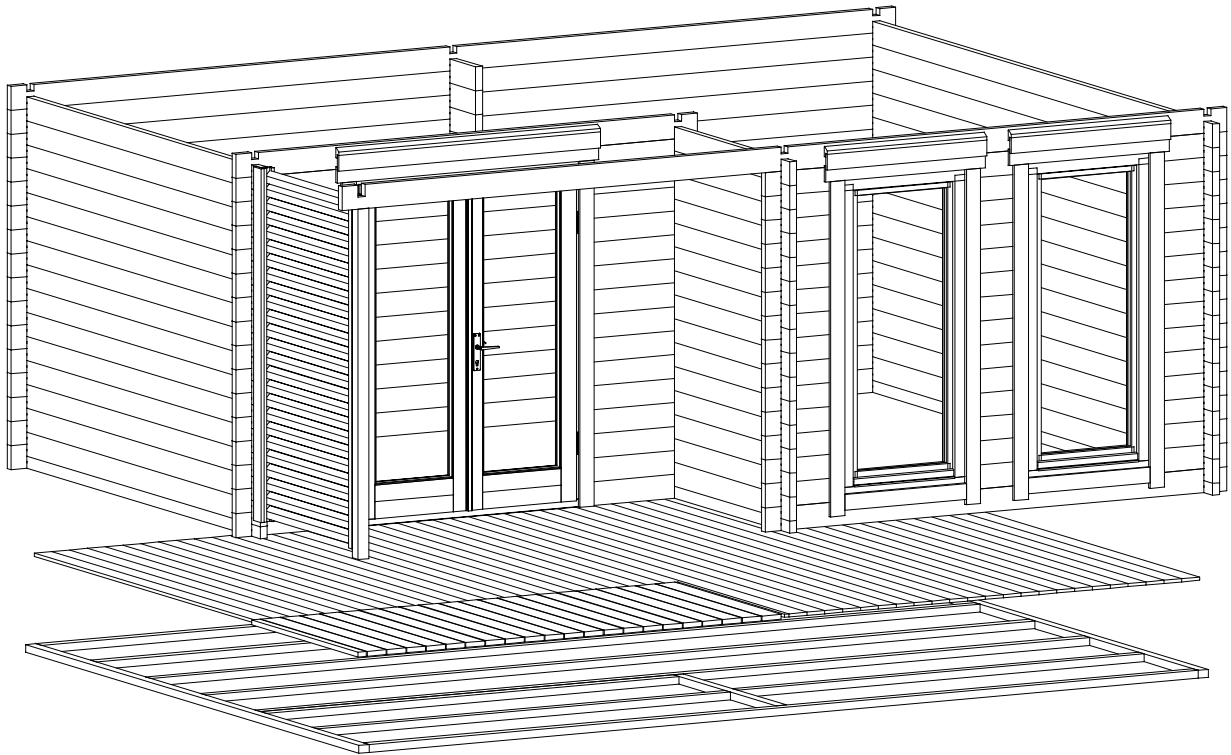

# Lagerholzplan und Fundamentplan Korpus für 845120

Wir empfehlen als Fundament für Ihr Gartenhaus eine vollflächig,  
festgegründete gepflasterte oder betonierte Fläche.  
Wahlweise ist auch ein Punkt- oder Streifenfundament möglich.

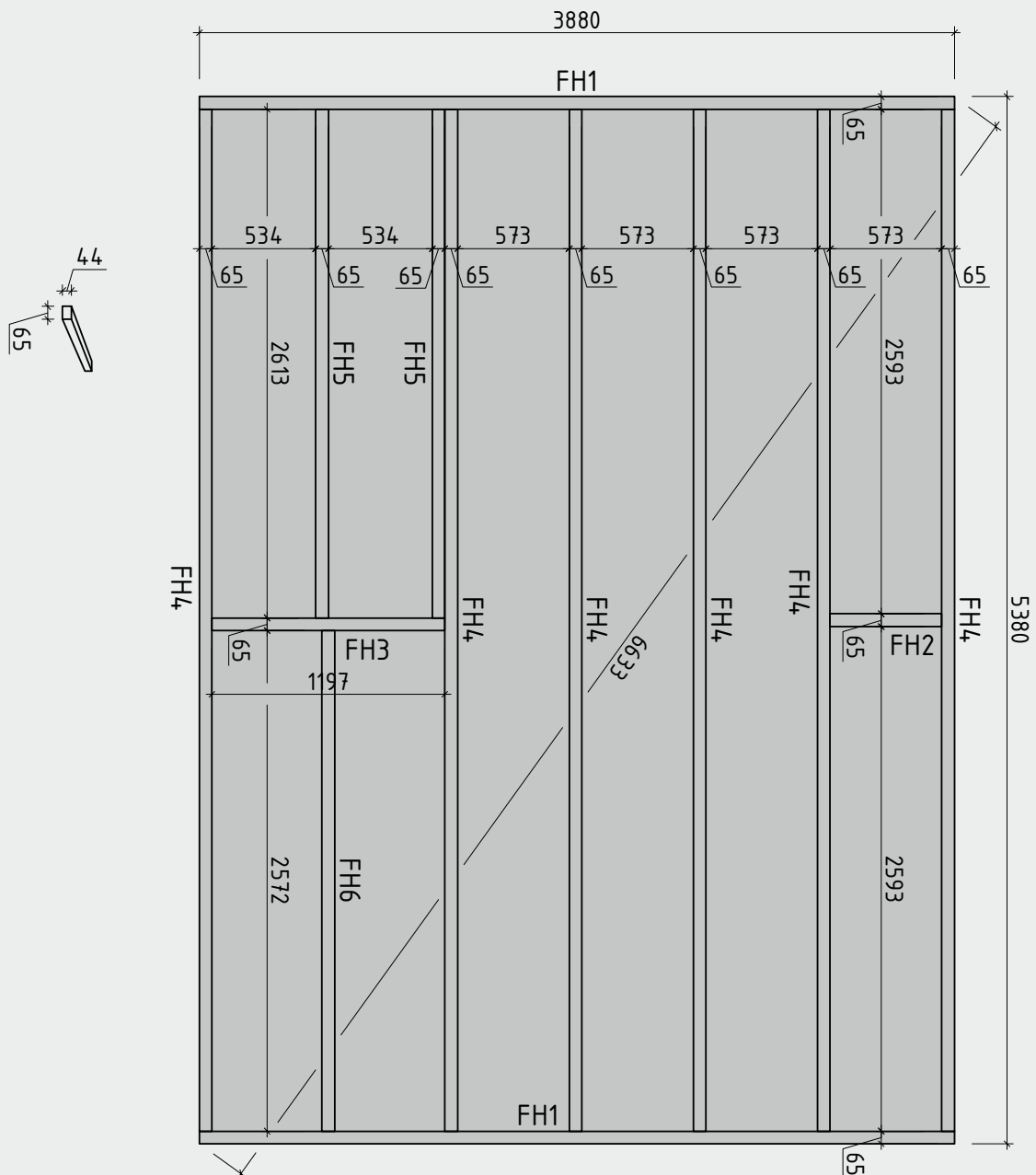













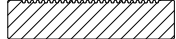

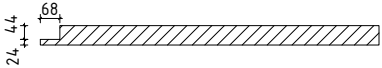
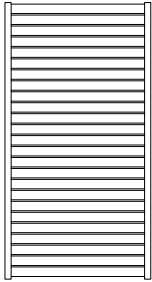



# Teileliste 1

## Korpus für 845120

Pos		Stck	Profil (mm)	Länge (mm)
001		16	44x135	5600
002		1	44x135	5600
003		15	44x135	4100
004		1	44x68	4100
005		1	44x135	2922
006		1	44x135	2922
007		15	44x135	2860
008		1	44x68	2860
009		15	44x135	1484
010		1	44x68	1484
011		30	44x135	718
012		14	44x135	454
013		14	44x135	454
014		6	44x135	444
015		2	44x135	444
016		7	44x135	444
017		1	44x68	444
018		12	44x135	314
019		2	44x135	314
FH4	FUNDAMENTHÖLZER (imprägniert) 	6	65x44	5250
FH1	FUNDAMENTHÖLZER (imprägniert) 	2	65x44	3880
FH5	FUNDAMENTHÖLZER (imprägniert) 	2	65x44	2613
FH6	FUNDAMENTHÖLZER (imprägniert) 	1	65x44	2572
FH3	FUNDAMENTHÖLZER (imprägniert) 	1	65x44	1197
FH2	FUNDAMENTHÖLZER (imprägniert) 	1	65x44	573

# Teileliste 2

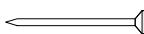
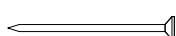
## Korpus für 845120

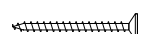
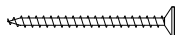
Pos		Stck	Profil (mm)	Länge (mm)
	FUSSBODENBRETTER 	24+1	113x18	3805
	FUSSBODENBRETTER 	23	113x18	2565
	TERRASSENBRETTER (imprägniert) 	22+1	120x28	1240
	FUSSBODENLEISTE  ✓		18x40	19,0 lfm
SP1-1	STÜTZPFOSTEN 68x68  ✓	1	68x68	2095
	GITTERWAND ELEMENT 	1	1072x1994	
	LEISTE FÜR GITTERWAND 	1	18x90	1994
SH	Schlaghölzer 	3		
SS02	Schlossschrauben M8x70 Mutter U-Scheibe (für Gitterwand) 	3	M8	
VP1	Verstellbare Pfostenstütze M10 	1	M10	
ML1	Metallstange 	4	D10	1170
KL1	Gewindestange M8 	3	M8	2000
KL2	Gewindestange M8 	1	M8	460
KL3	Gewindestange M8 	2	M8	405
KL4	Gewindestange M8 	2	M8	325
	Mutter M8 U-Scheibe Ø25 	10	M8	
	Befestigungsmutter M8 	3	M8	
NG1	NÄGEL 2.5x50 Fussbodenbretter 	564		
NG2	NÄGEL 2.5x60 Terrassenbretter 	132		
SR01	SCHRAUBEN 3.0x30 Fussbodenleisten 	42		
SR03	SCHRAUBEN 3.5x45 Gitterwand Fenster- und Türleisten 	86		
SR05	SCHRAUBEN 4.0x60 Wasserleisten WL1 	10		

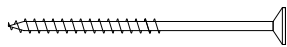
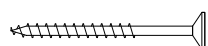
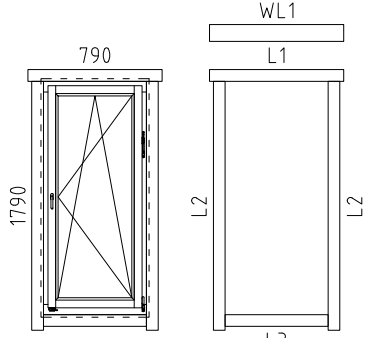
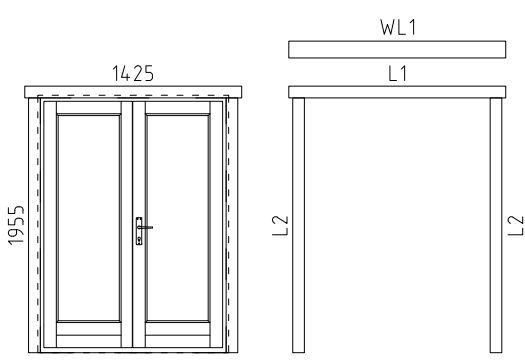
Pos		Stck	Profil (mm)	Länge (mm)
SR11	SCHRAUBEN 5.0x100 Fundamenthölzer 	52		
SR10	SCHRAUBEN 5.0x70 Gitterwand 	4		
	<p align="center"><b>FENSTER 790x1790</b></p>  <p align="center">A68-11</p> <ul style="list-style-type: none"> <li>L1 18x90 L=1030mm 2 Stck.</li> <li>L2 18x90 L=1910mm 4 Stck.</li> <li>L3 18x90 L=790mm 2 Stck. ✓</li> <li>WL1 36x129 L=1030mm 1 Stck.</li> </ul>	2		
	<p align="center"><b>TÜR 1425x1955</b></p>  <p align="center">TU4-GH+</p> <ul style="list-style-type: none"> <li>L1 18x90 L=1665mm 2 Stck.</li> <li>L2 18x90 L=1955mm 4 Stck. ✓</li> <li>WL1 36x129 L=1665mm 1 Stck.</li> </ul> <p>DIN rechts</p>	1		
	✓ - bitte selber anpassen (falls nötig!)			

# Teileliste 3

## Korpus für 845120

### Montageanleitung für Gitterwand

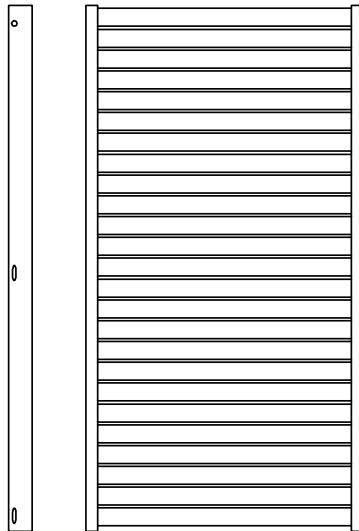

Schrauben 3.5\*45mm

6 Stck.



Schrauben 5x70mm

4 Stck.

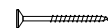

Schlossschrauben M8x70  
Mutter U-Scheibe

3 Stck.

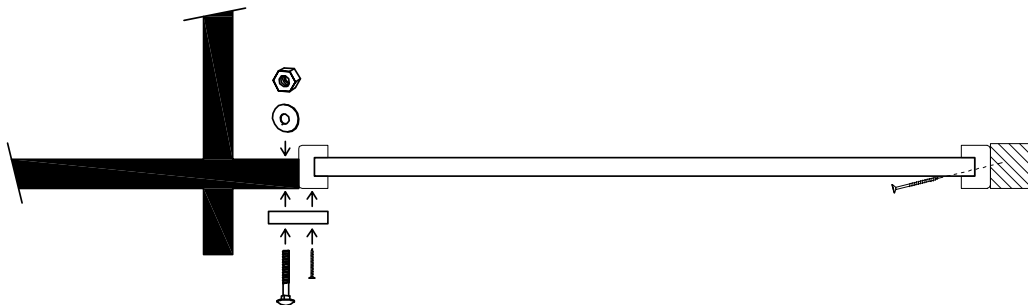
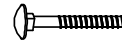

Spiegelverkehrt

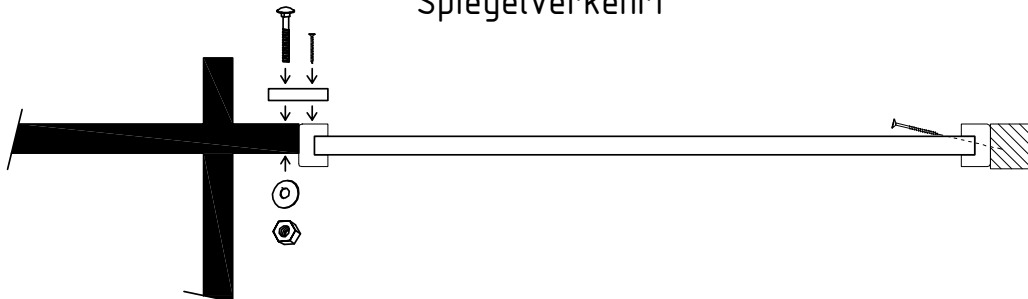

# Wandplan 1 und 2 Korpus für 845120

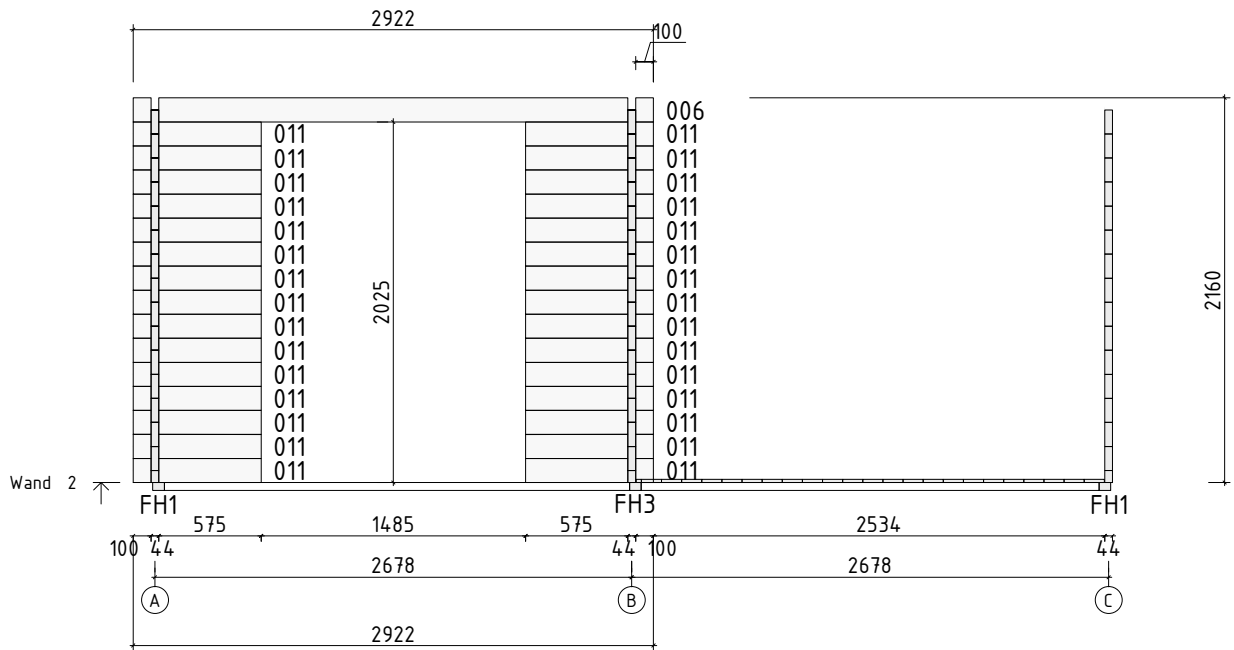
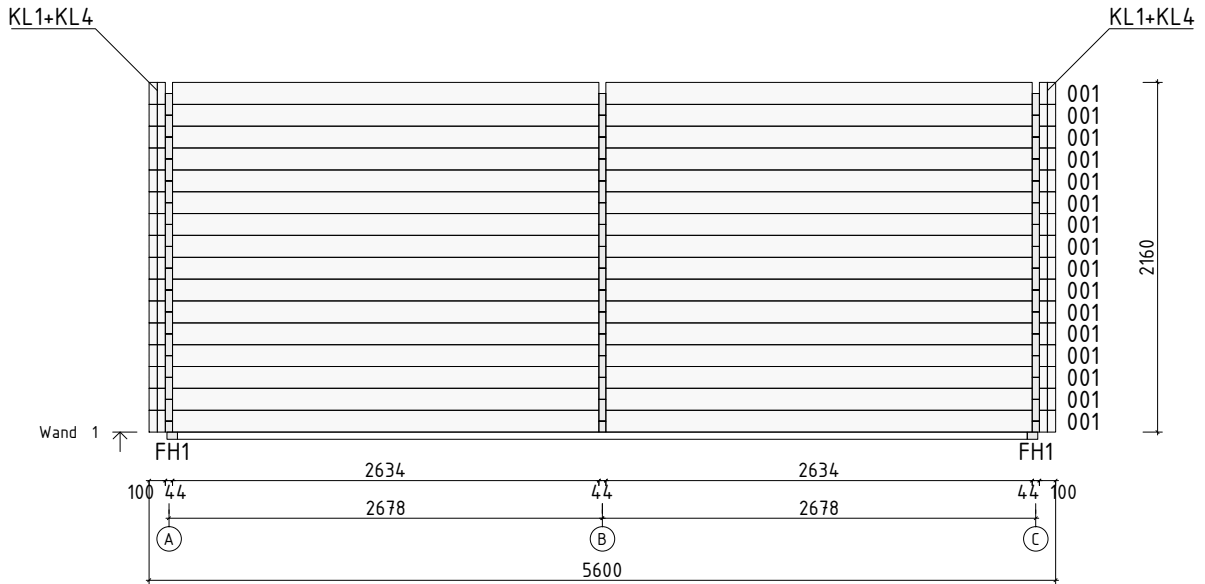



# Wandplan 3 Korpus für 845120

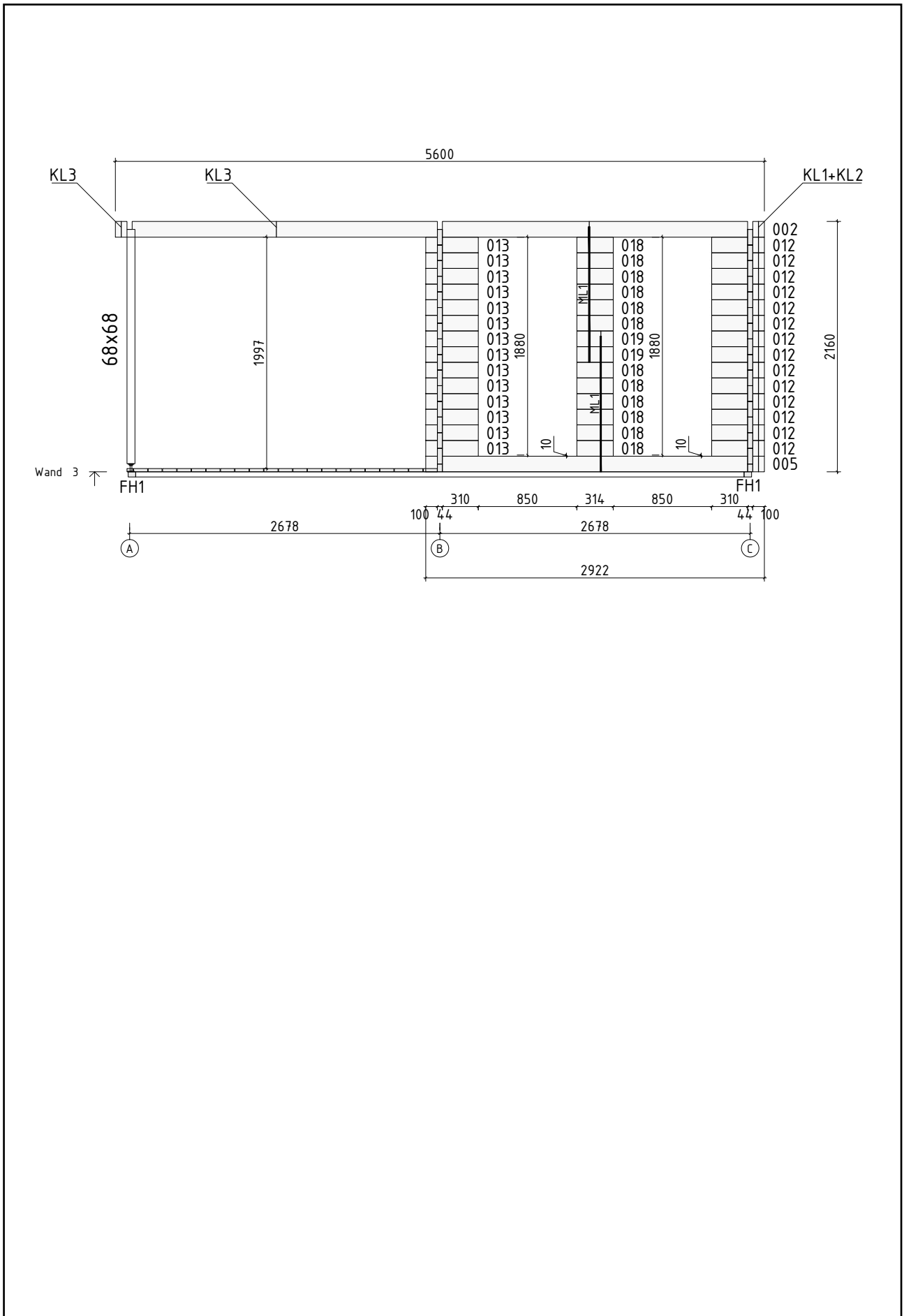

# Wandplan A und B

## Korpus für 845120

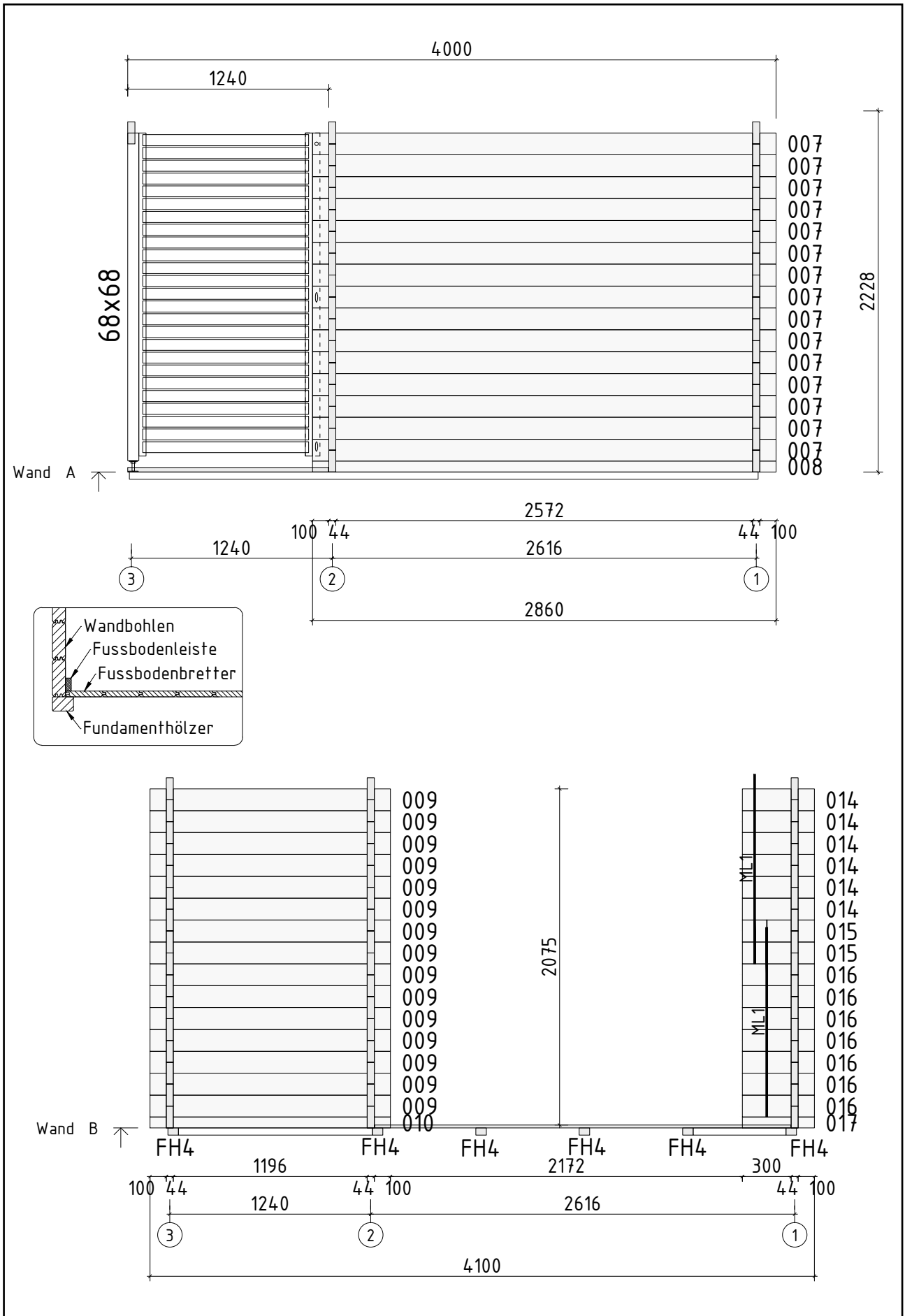

# Wandplan C

## Korpus für 845120

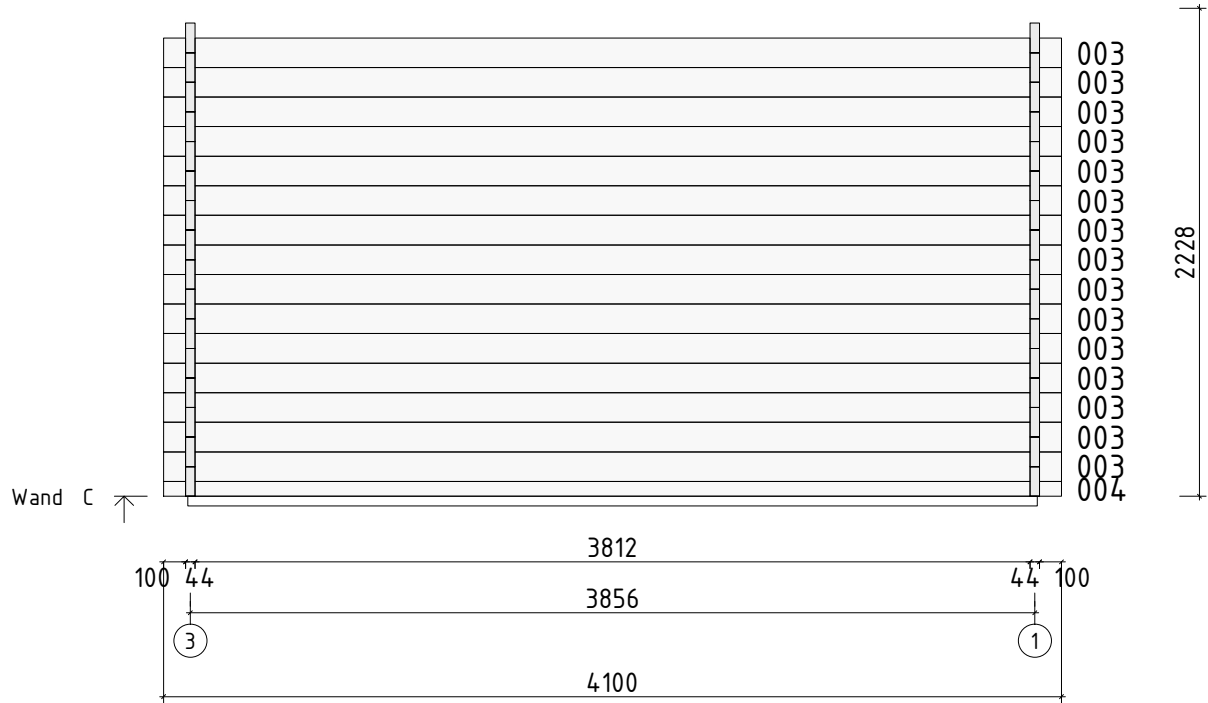

**845120 Flachdach**  
**Wandaußenmaß: 560 x 410 cm**  
**Bohlenstärke: 44 mm**



Cordoba 44-B Modern

Kontrolliert durch:

Achtung: Alle angegebenen Maße sind ca.-Maße!

# 3D-Darstellung und Grundriss 845120

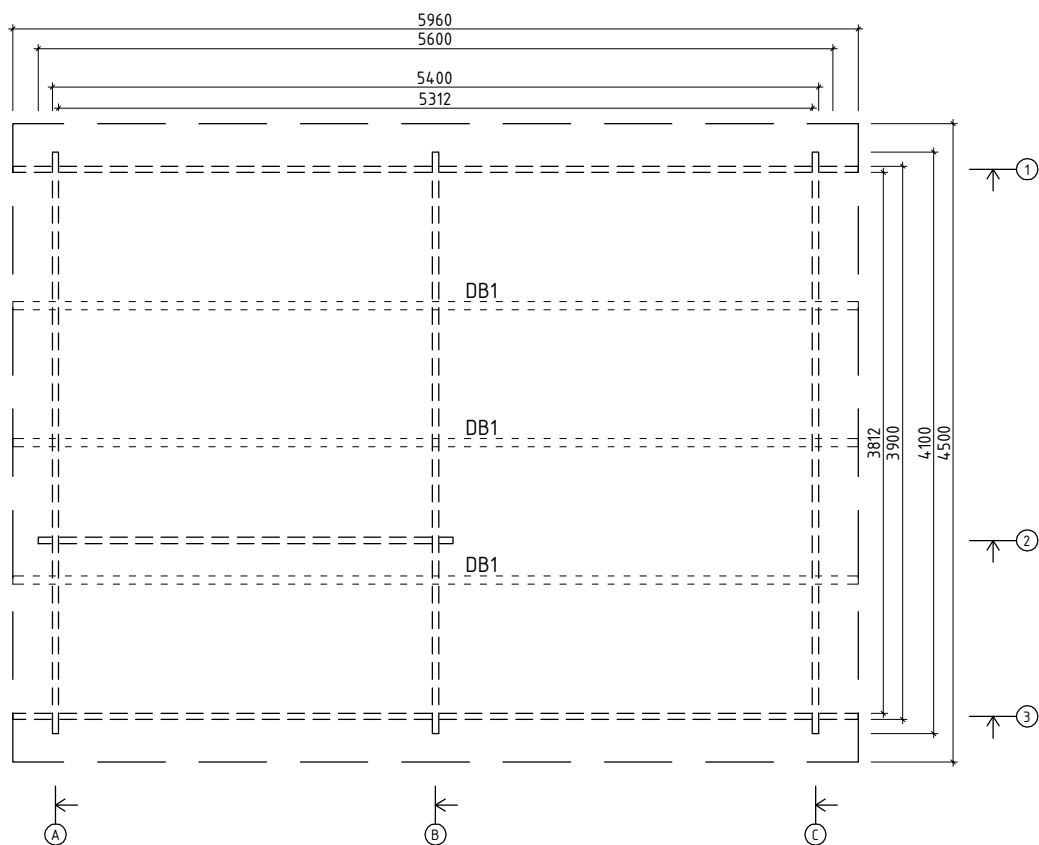
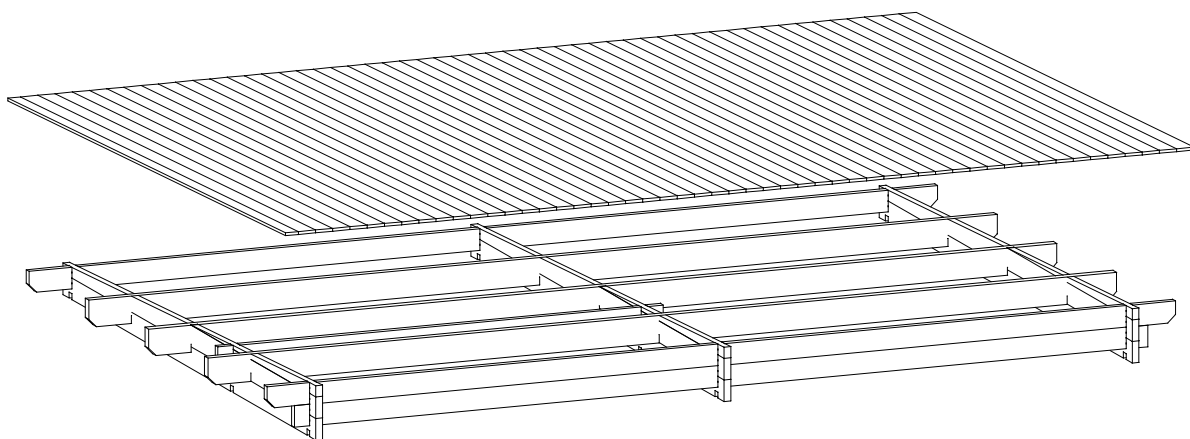

# Teileliste 1

## 845120 Flachdach

Pos		Stck	Profil (mm)	Länge (mm)
001		1	44x134	5960
002		1	44x134	5960
003		1	44x135	5600
004		1	44x135	4100
005		2	44x135	4100
006		1	44x135	4100
007		1	44x135	4100
008		1	44x135	4100
009		1	44x90	2922
010		1	44x135	2922
011		2	44x71	2028
012		1	44x71	2028
DB1		3	58x170	5960
	DACHBRETTER	53+1	113x18	4505
G1-1	GIEBELBRETTER 120X18	2	120x18	4525
G6-1	GIEBELDECKLEISTE 40X18	✓ 2	40x18	4525
T1-1	TRAUFENBRETTER 120X18	1	120x18	5996
T2-1	TRAUFENBRETTER 90X18	1	90x18	5960
T4-1	TRAUFENLEISTE 40x18	✓	40x18	12,0 lfm
T6-1	TRAUFENDECKLEISTE 40x18	2	40x18	3000
SH	Schlaghölzer	3		
NG3	DACHPAPPNÄGEL 2.0x18	550		
NG1	NÄGEL 2.5x50 Dachbretter	530		
SR01	SCHRAUBEN 3.0x30 Giebeldeckleisten, Traufenleisten, Traufendeckleisten	56		
SR03	SCHRAUBEN 3.5x45 Giebelbretter, Traufenbretter	44		
	DACHPAPPE	✓	6,0m-5st.	30,0 lfm
	✓ - bitte selber anpassen (falls nötig)!			

# Wandplan 1 und 2 845120 Flachdach

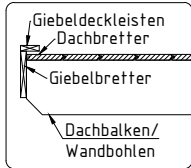
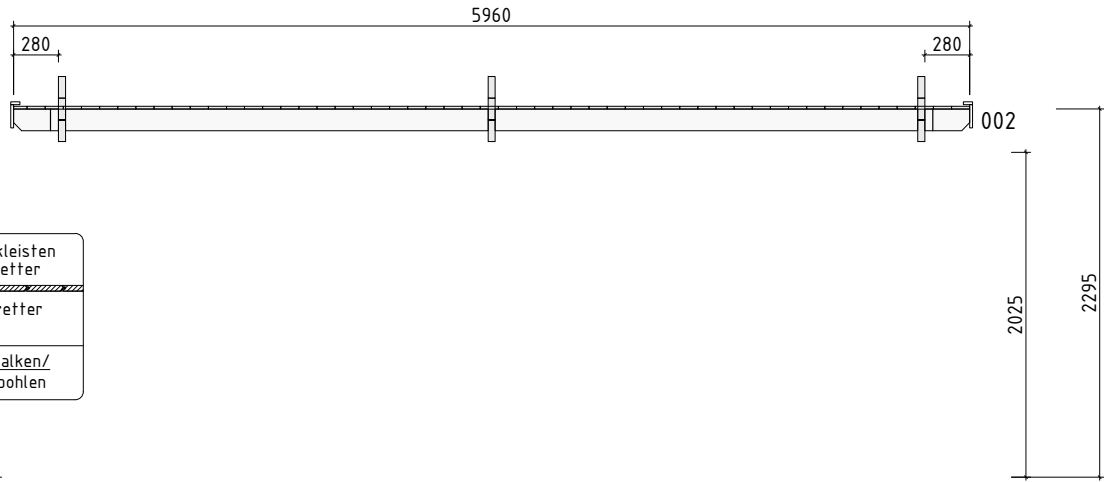

Wand 1 ↗

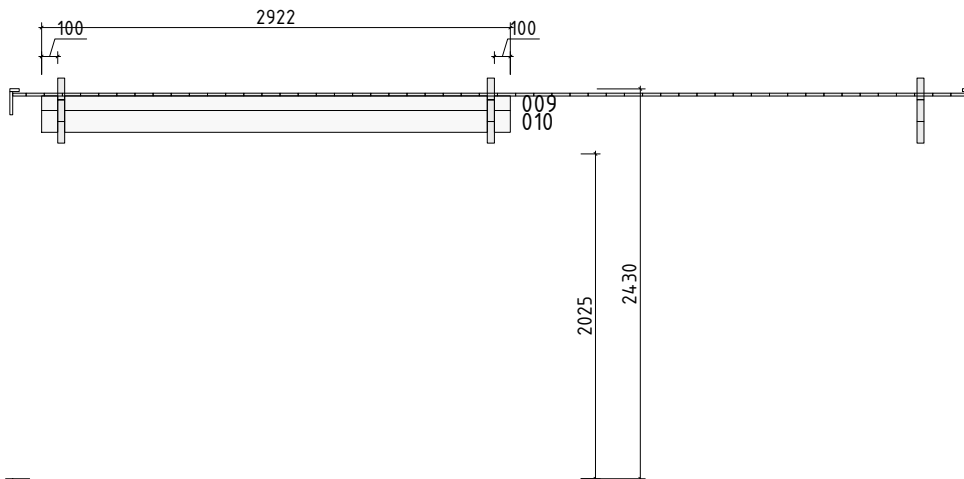
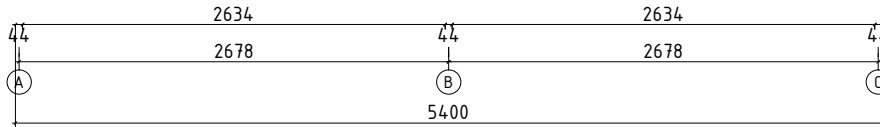

Wand 2 ↗

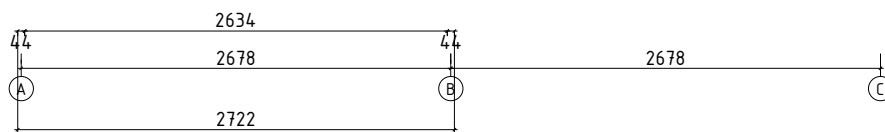

# Wandplan 3

## 845120 Flachdach

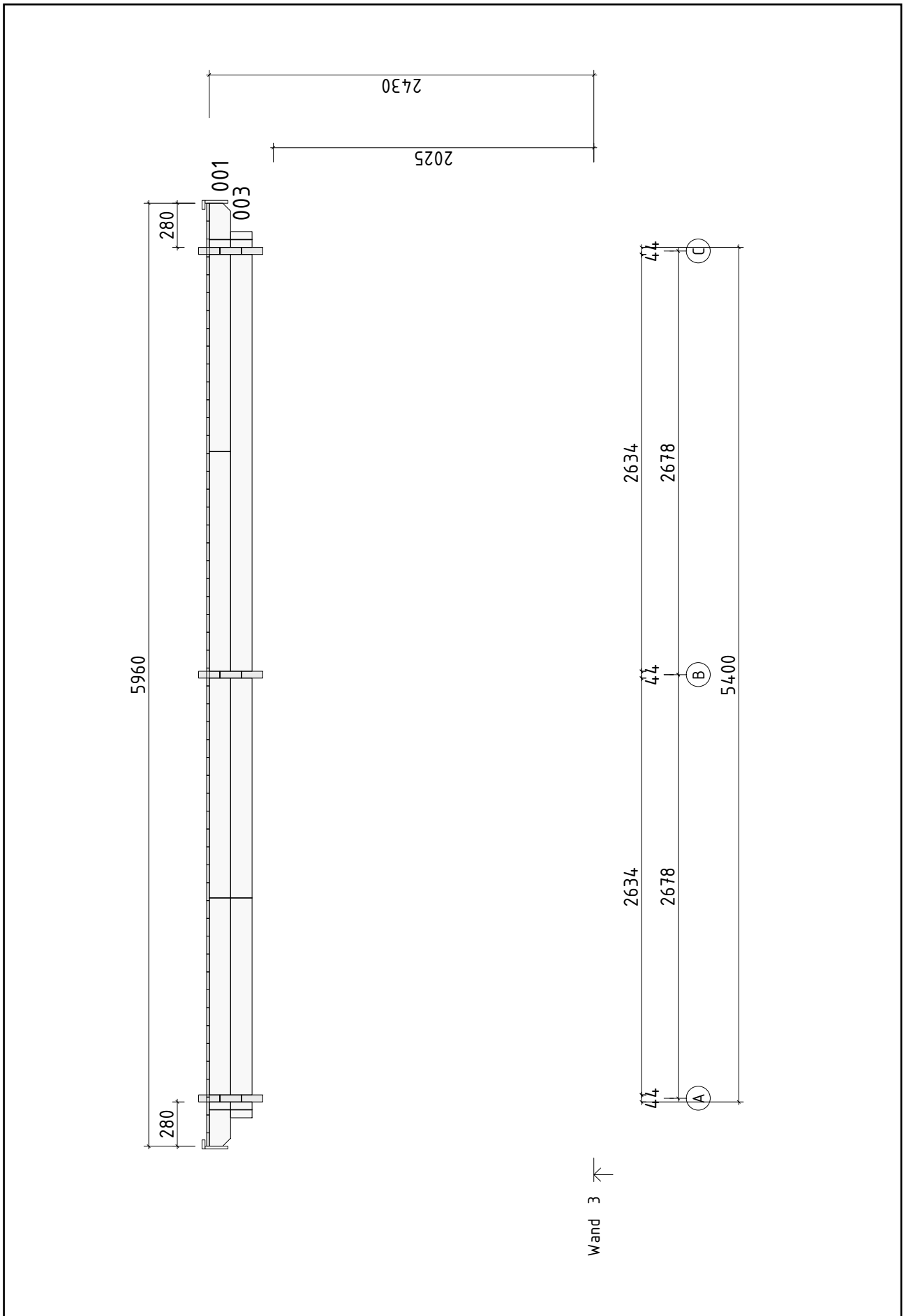



# Wandplan A

## 845120 Flachdach

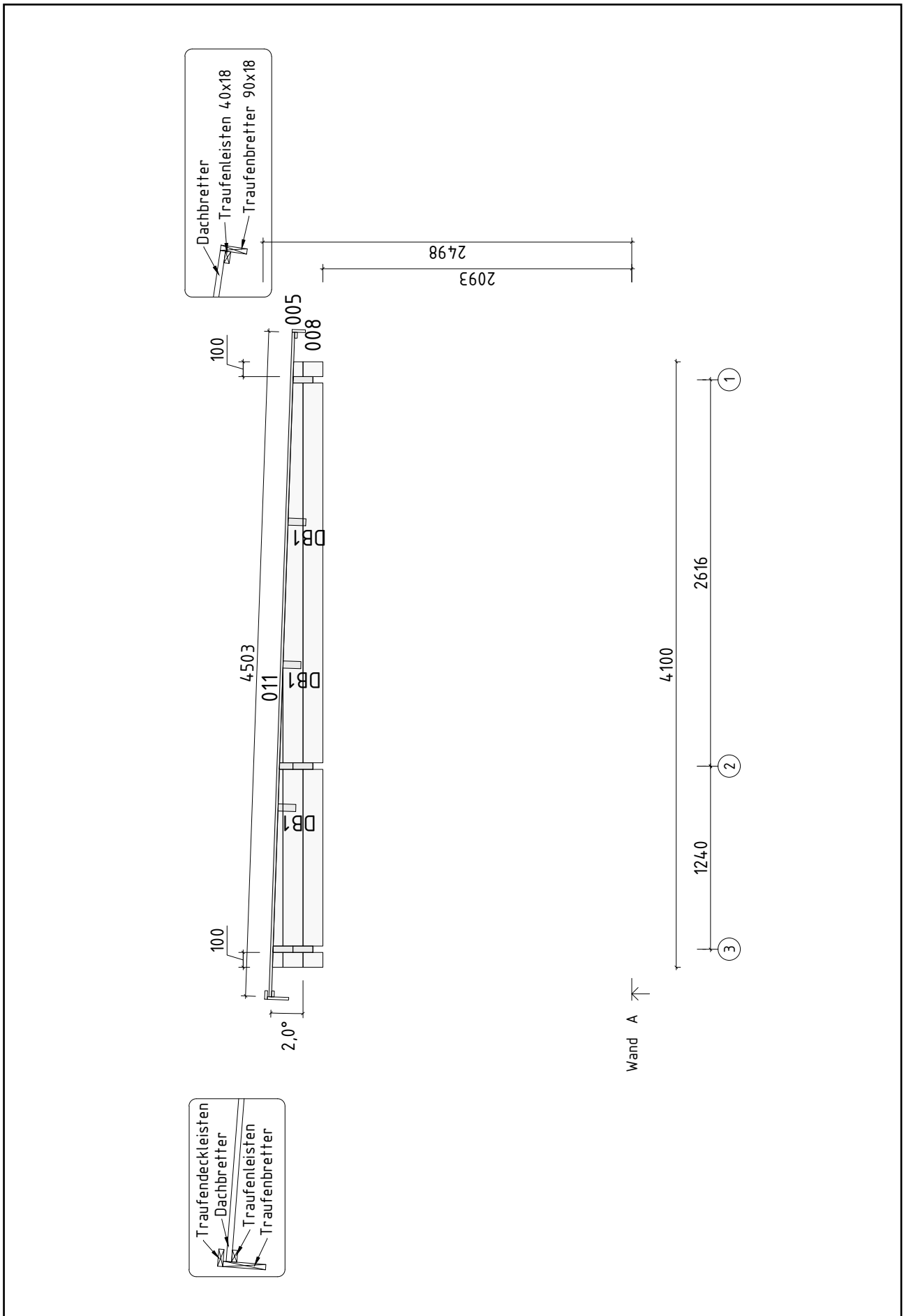

# Wandplan B und C

## 845120 Flachdach

