

# Technische Daten: Art.-Nr.: 845170

Wandaußenmaß: 540 x 390 cm

Bohlenstärke: 44 mm



Cordoba 44-A Klassik

Kontrolliert durch:

Empty box for signature or name.

Achtung: Alle angegebenen Maße sind ca.-Maße!

# 3D-Darstellung und Grundriss 845170

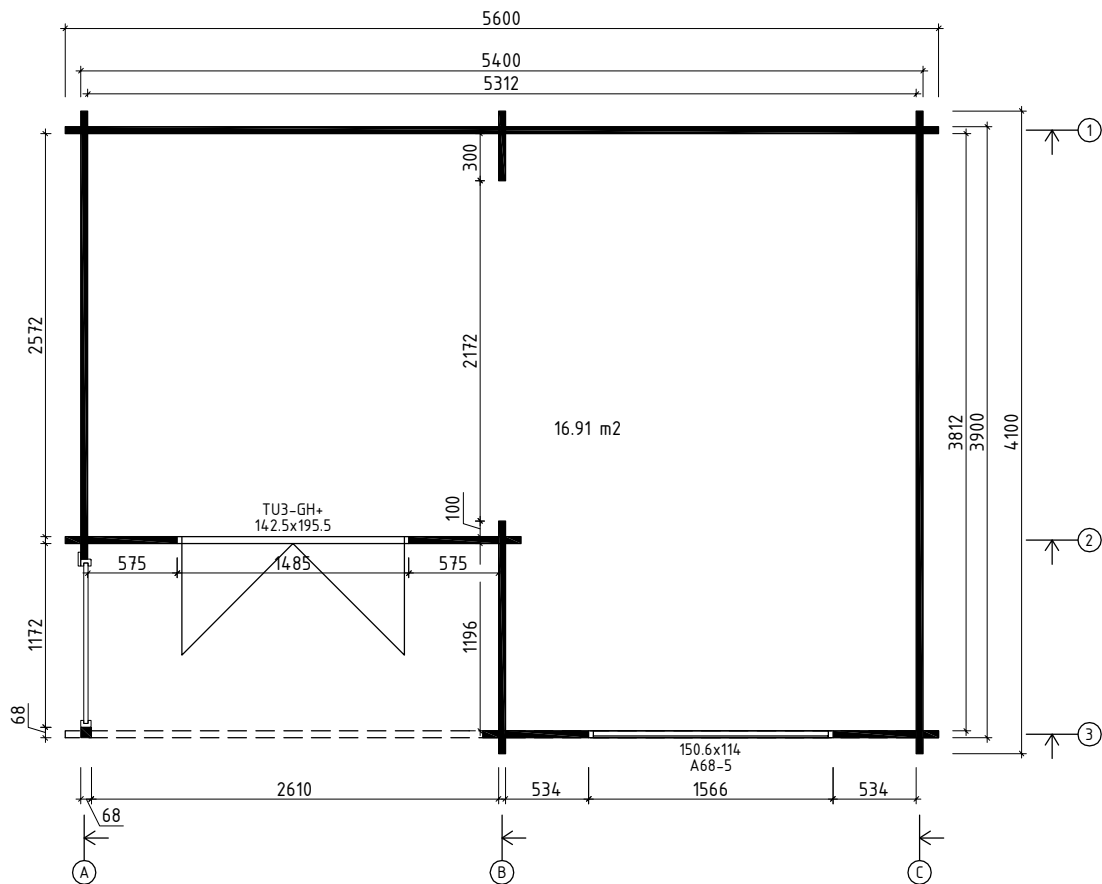
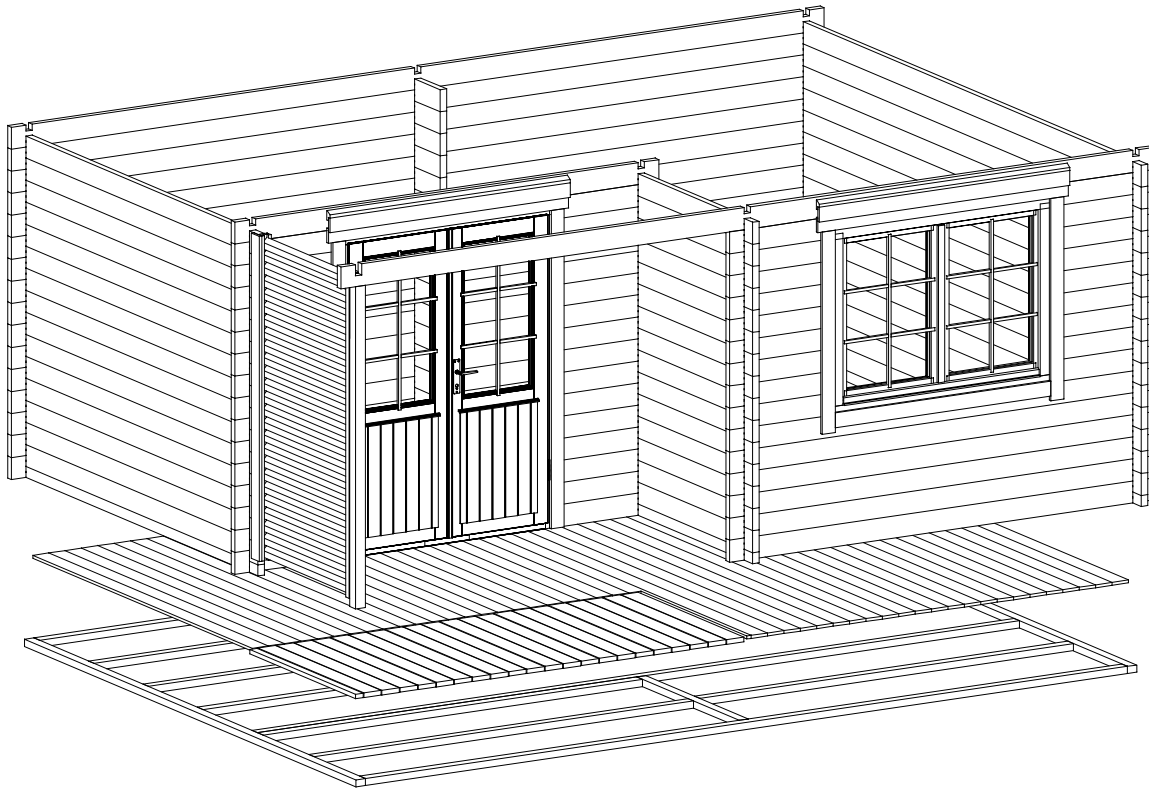





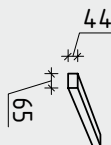
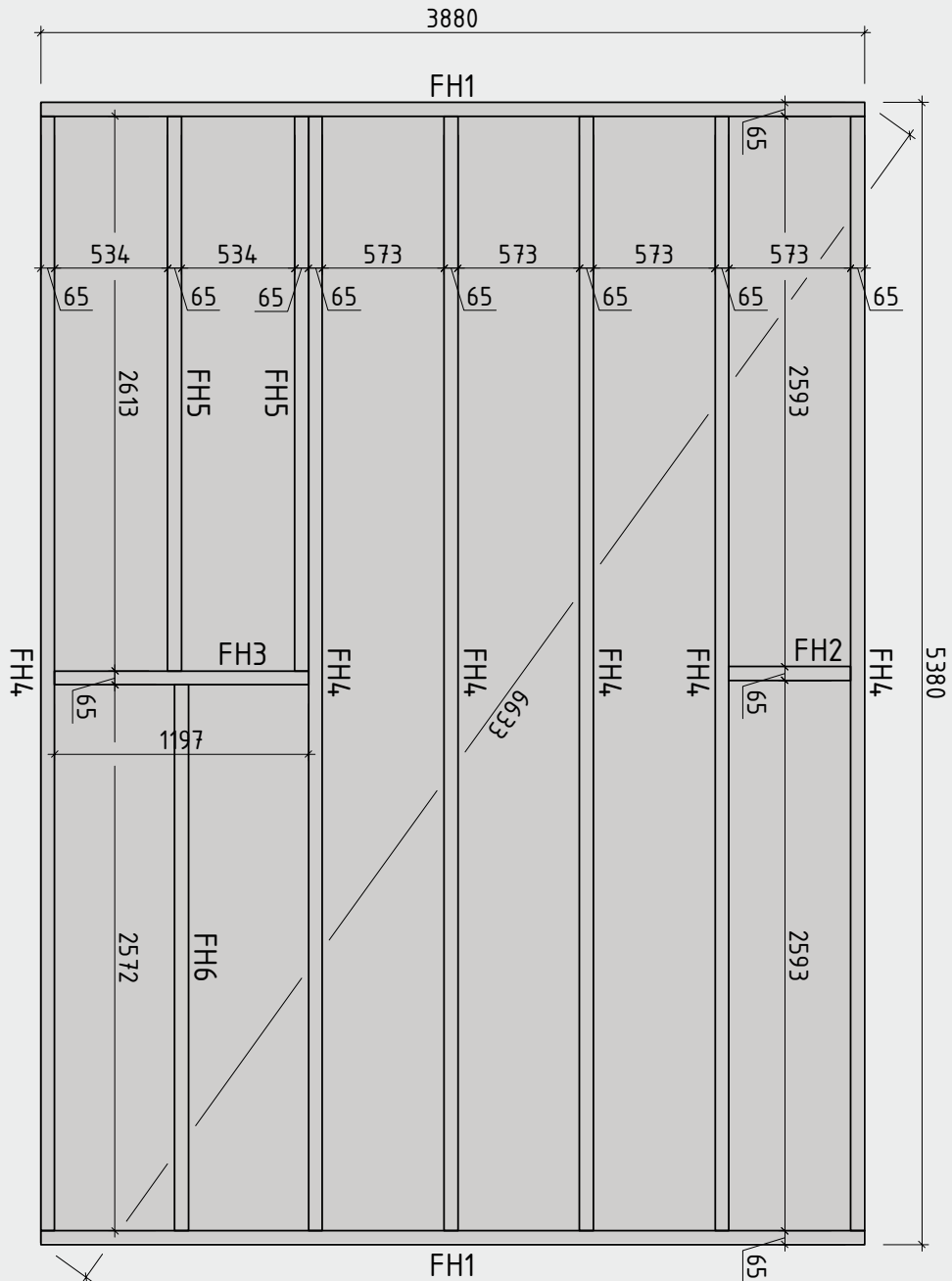





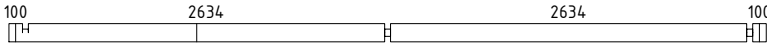

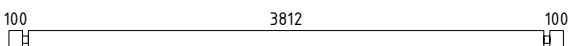
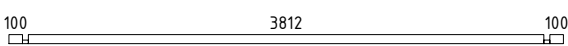
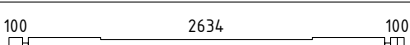
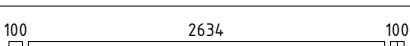
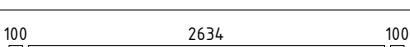
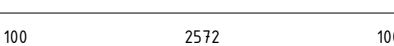
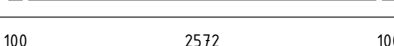
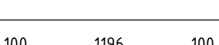
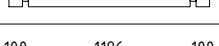



# Lagerholzplan und Fundamentplan 845170

Wir empfehlen als Fundament für Ihr Gartenhaus eine vollflächig festgegründete, gepflasterte oder betonierte Fläche.  
Wahlweise ist auch ein Punkt- oder Streifenfundament möglich.

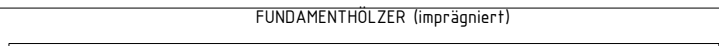











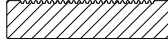

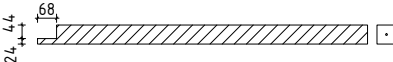
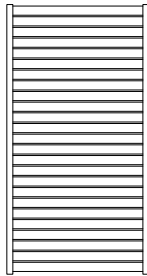
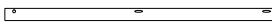



# Teileliste 1

## 845170

Pos		Stck	Profil (mm)	Länge (mm)
001		1	44x135	5600
002		16	44x135	5600
003		15	44x135	4100
004		1	44x68	4100
005		1	44x135	2922
006		5	44x135	2922
007		1	44x135	2922
008		15	44x135	2860
009		1	44x68	2860
010		15	44x135	1484
011		1	44x68	1484
012		30	44x135	718
013		9	44x135	678
014		9	44x135	678
015		6	44x135	444
016		2	44x135	444
017		7	44x135	444
018		1	44x68	444
FH4	FUNDAMENTHÖLZER (imprägniert) 	6	65x44	5250
FH1	FUNDAMENTHÖLZER (imprägniert) 	2	65x44	3880
FH5	FUNDAMENTHÖLZER (imprägniert) 	2	65x44	2613
FH6	FUNDAMENTHÖLZER (imprägniert) 	1	65x44	2572
FH3	FUNDAMENTHÖLZER (imprägniert) 	1	65x44	1197
FH2	FUNDAMENTHÖLZER (imprägniert) 	1	65x44	573
	FUSSBODENBRETTER 	24+1	113x18	3805

# Teileliste 2

## 845170

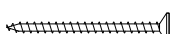
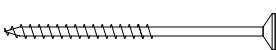
Pos		Stck.	Profil (mm)	Länge (mm)		
	FUSSBODENBRETTER		23+1	113x18	2565	
	TERRASSENBRETTER (imprägniert)		22+1	120x28	1240	
	FUSSBODENLEISTE		✓	18x40	19,0 lfm	
SP1-1	STÜTZPFOSTEN 68x68		✓	1	68x68	2095
	GITTERWAND ELEMENT		1	1072x1994		
	LEISTE FÜR GITTERWAND		1	18x90	1994	
SH	Schlaghölzer		3			
SS02	Schlossschrauben M8x70 Mutter U-Scheibe (für Gitterwand)		3	M8		
VP1	Verstellbare Pfostenstütze M10		1	M10		
ML1	Metallstange		2	D10	1170	
KL1	Gewindestange M8		3	M8	2000	
KL2	Gewindestange M8		1	M8	460	
KL3	Gewindestange M8		2	M8	405	
KL4	Gewindestange M8		2	M8	325	
	Mutter M8 U-Scheibe Ø25		10	M8		
	Befestigungsmutter M8		3	M8		
NG1	NÄGEL 2.5x50 Fussbodenbretter		564			
NG2	NÄGEL 2.5x60 Terrassenbretter		132			
SR01	SCHRAUBEN 3.0x30 Fussbodenleisten		42			
SR03	SCHRAUBEN 3.5x45 Gitterwand Fenster- und Türeleisten		58			
SR05	SCHRAUBEN 4.0x60 Wasserleisten WL1		8			
SR11	SCHRAUBEN 5.0x100 Fundamenthölzer		52			



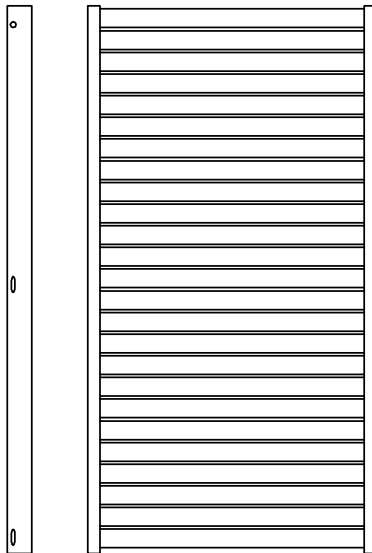

# Montageanleitung für Gitterwand 845170

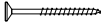

Schrauben 3,5\*45mm 6 Stck. 

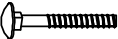
Schrauben 5x70mm 4 Stck. 

Schlossschrauben M8x70 3 Stck.     
Mutter U-Scheibe

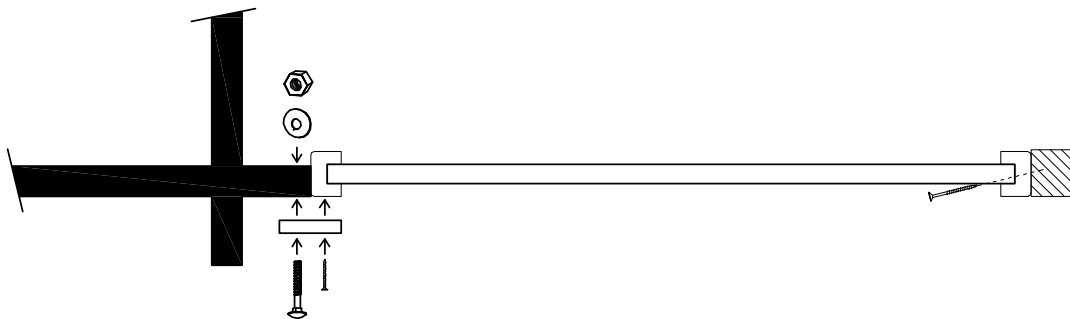

Spiegelverkehrt



# Wandplan 1 und 2 845170

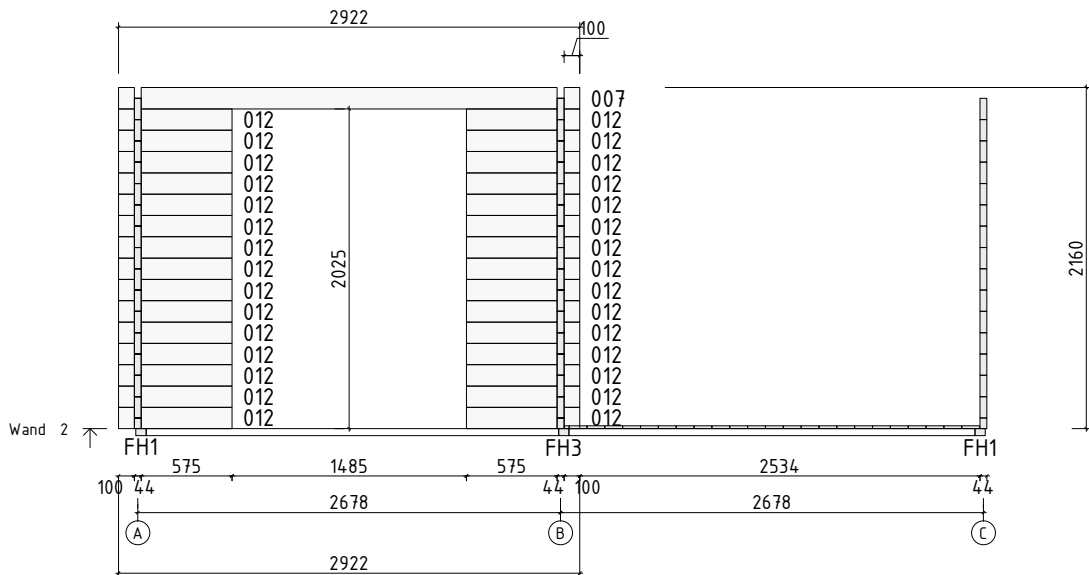
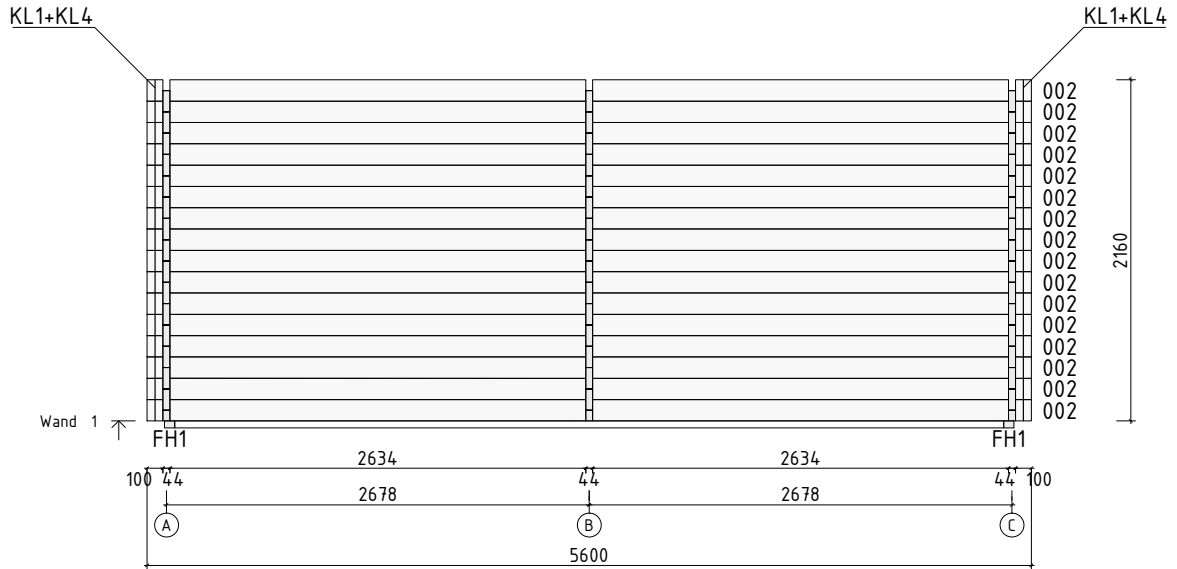



# Wandplan 3 845170

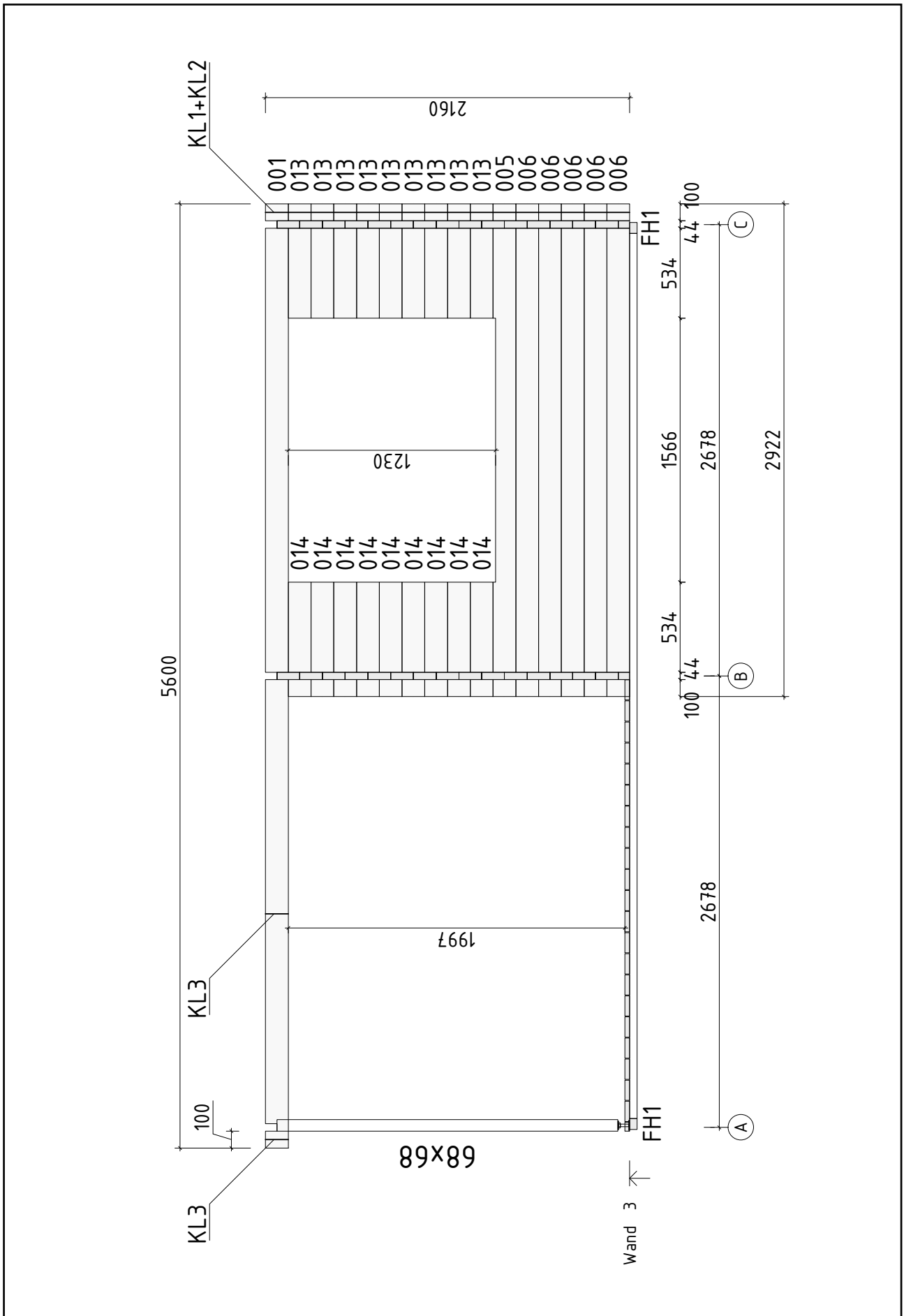

# Wandplan A 845170

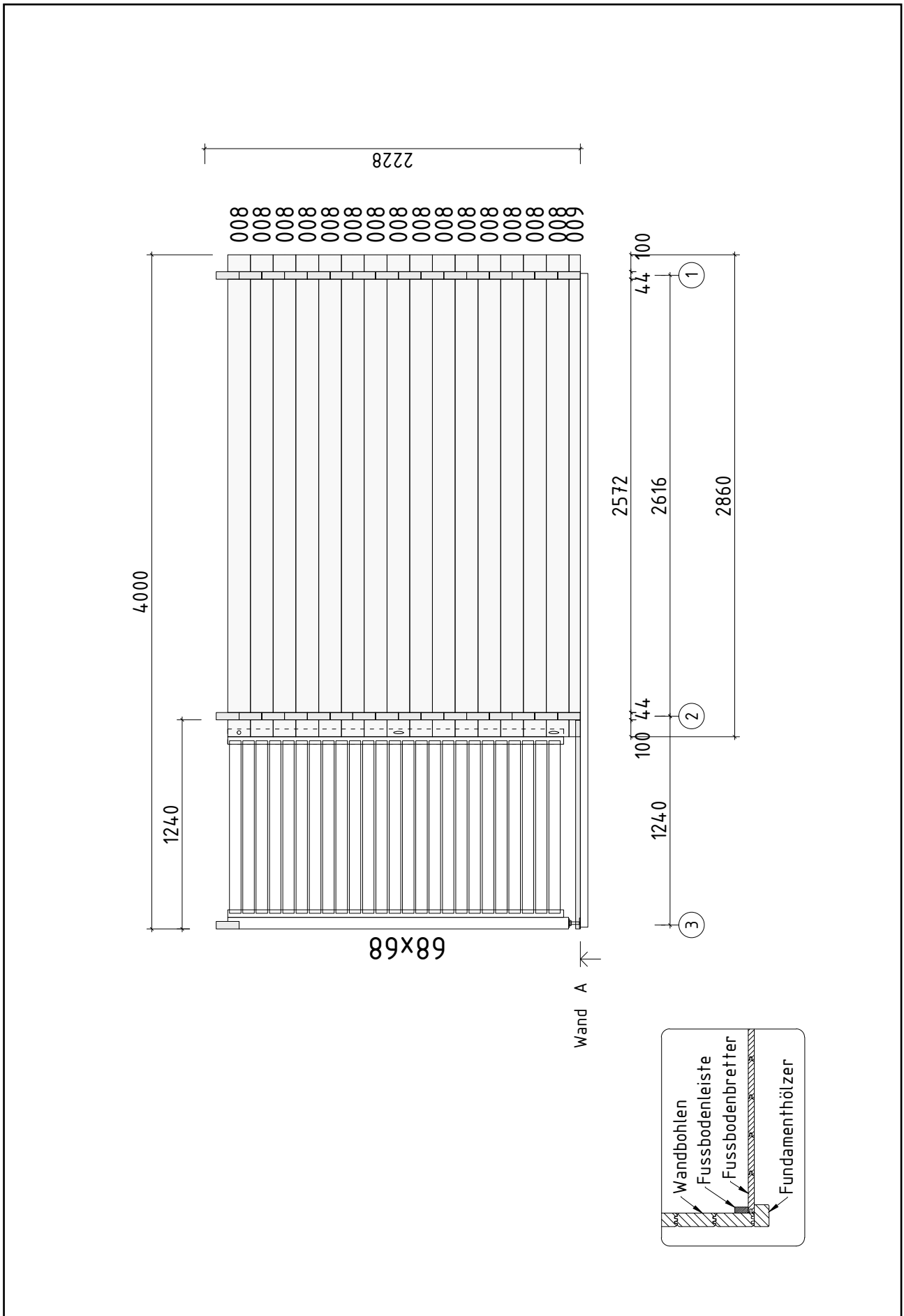



# 845170 Flachdach

Wandaußenmaß: 560 x 410 cm

Bohlenstärke: 44 mm



Cordoba 44-A Klassik

Kontrolliert durch:

Achtung: Alle angegebenen Maße sind ca.-Maße!

# 3D-Darstellung und Grundriss 845170 Flachdach

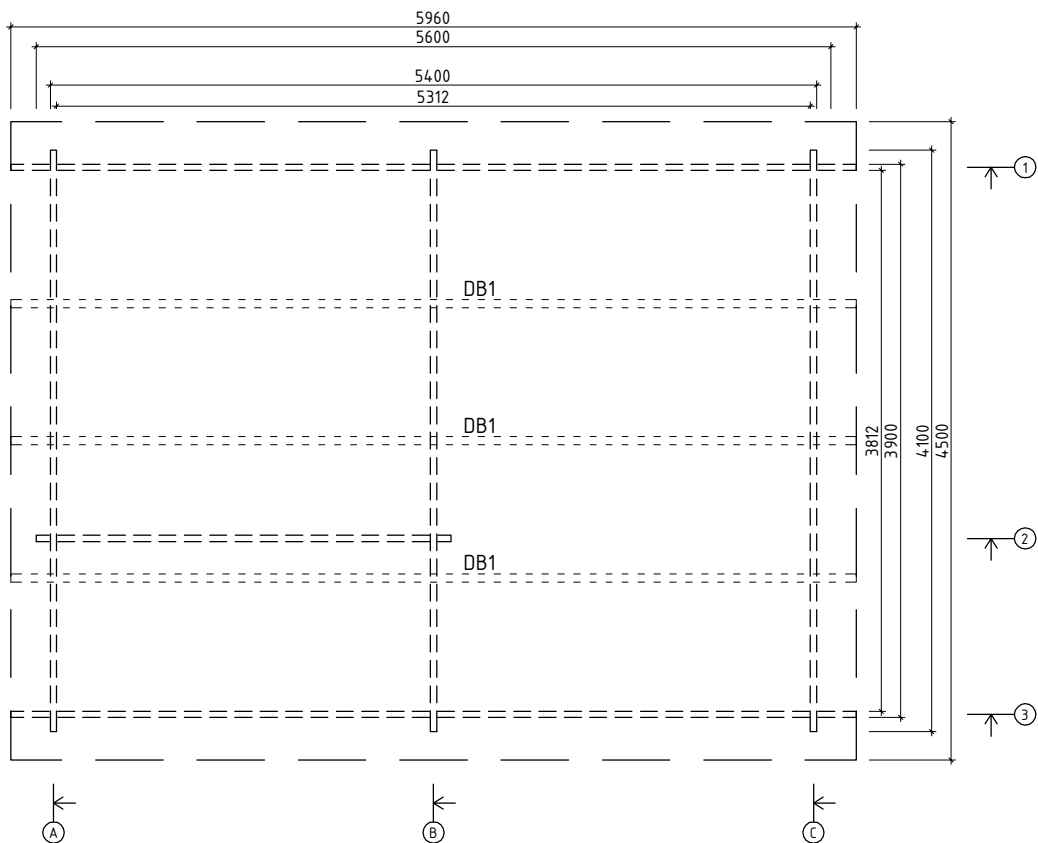
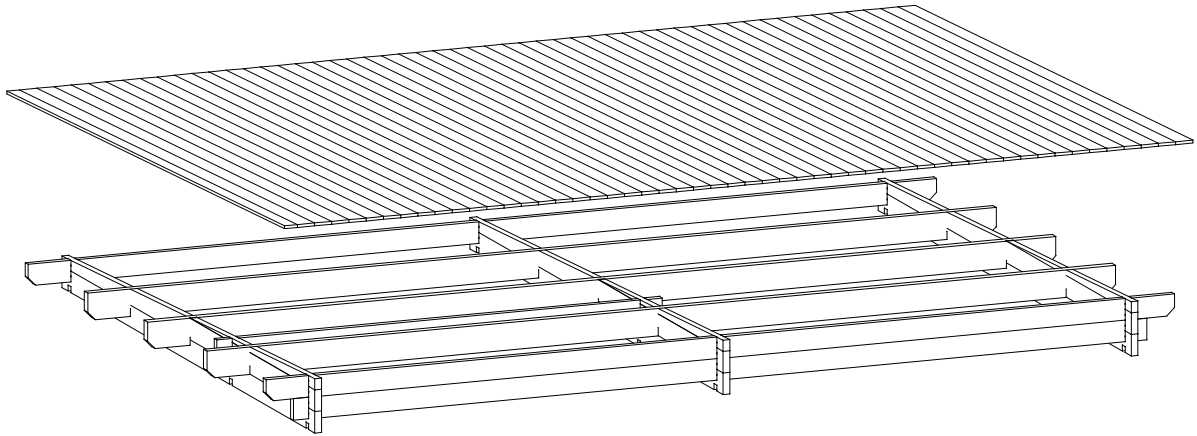

# Teileliste 1

## 845170 Flachdach

Pos		Stck	Profil (mm)	Länge (mm)
001		1	44x134	5960
002		1	44x134	5960
003		1	44x135	5600
004		1	44x135	4100
005		2	44x135	4100
006		1	44x135	4100
007		1	44x135	4100
008		1	44x135	4100
009		1	44x90	2922
010		1	44x135	2922
011		2	44x71	2028
012		1	44x71	2028
DB1		3	58x170	5960
	DACHBRETTER	53+1	113x18	4505
G1-1	GIEBELBRETTER 120X18	2	120x18	4525
G6-1	GIEBELDECKLEISTE 40X18	✓ 2	40x18	4525
T1-1	TRAUFENBRETTER 120X18	1	120x18	5996
T2-1	TRAUFENBRETTER 90X18	1	90x18	5960
T4-1	TRAUFENLEISTE 40x18	✓	40x18	12,0 lfm
T6-1	TRAUFENDECKLEISTE 40x18	2	40x18	3000
SH	Schlaghölzer	3		
NG3	DACHPAPPNÄGEL 2.0x18	550		
NG1	NÄGEL 2.5x50 Dachbretter	530		
SR01	SCHRAUBEN 3.0x30 Giebeldeckleisten, Traufenleisten, Traufendeckleisten	56		
SR03	SCHRAUBEN 3.5x45 Giebelbretter, Traufenbretter	44		
	DACHPAPPE	✓	6,0m-5st.	30,0 lfm
	✓ - bitte selber anpassen (falls nötig)!			

# Wandplan 1 und 2 845170 Flachdach

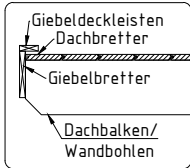
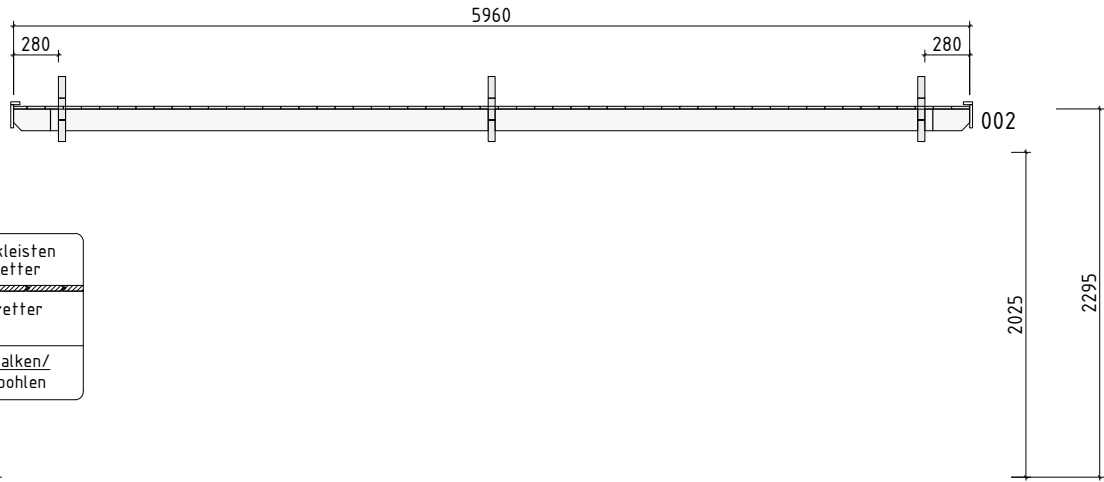

Wand 1 ↗

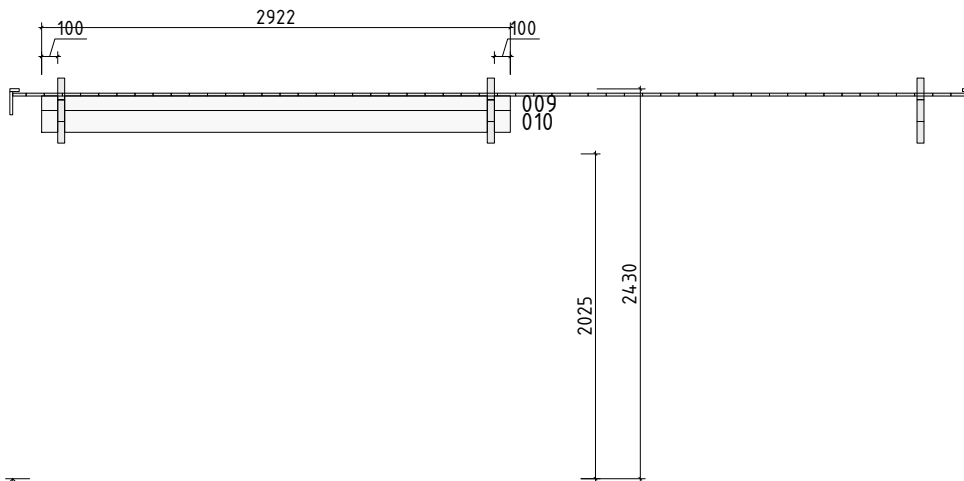
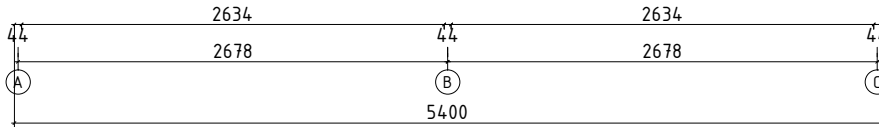

Wand 2 ↗

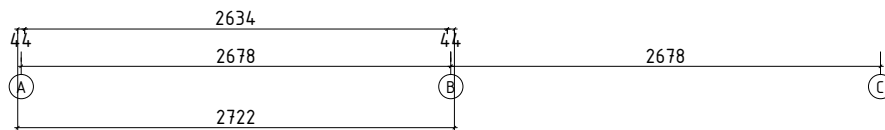

# Wandplan 3

## 845170 Flachdach

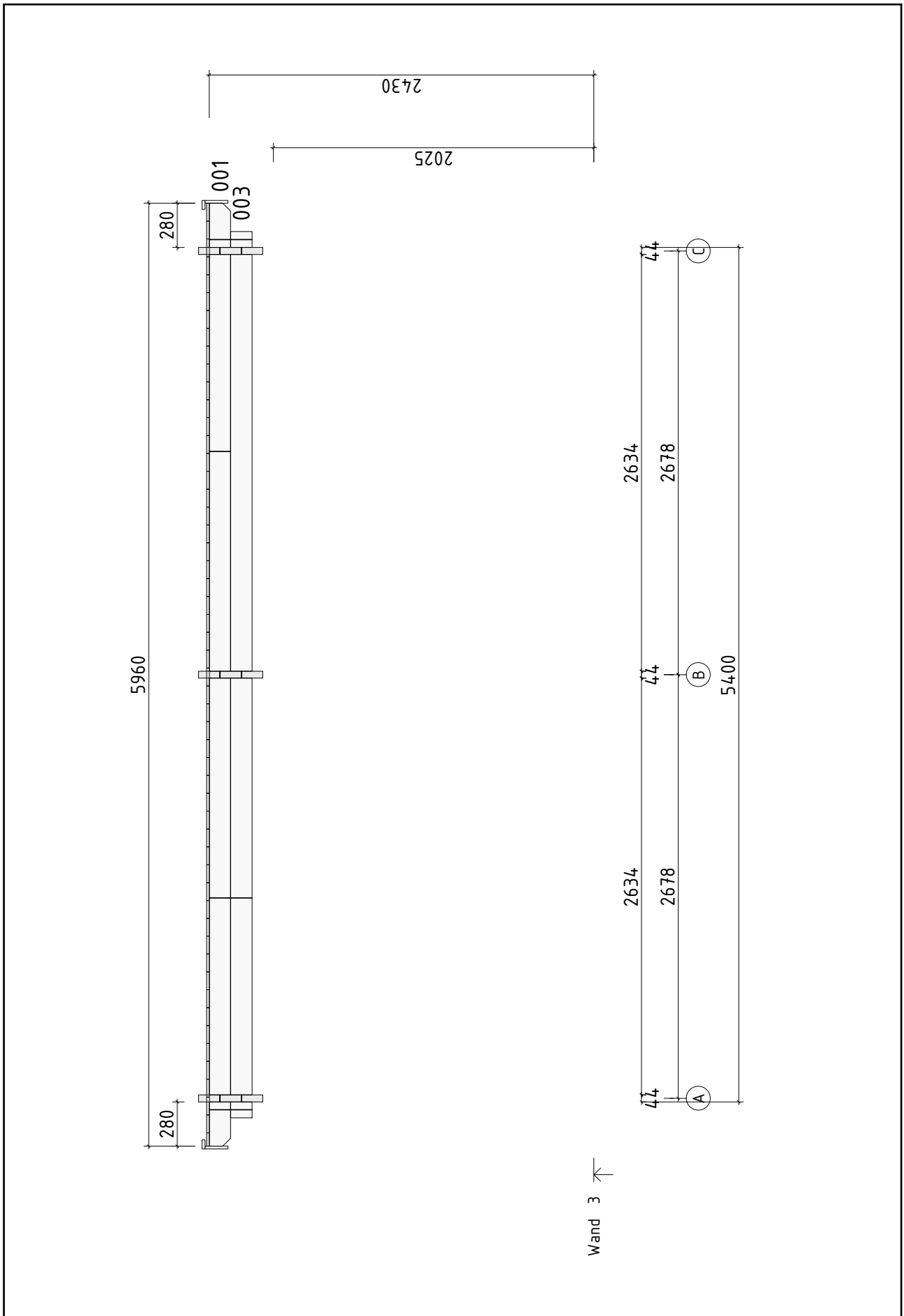



# Wandplan A

## 845170 Flachdach

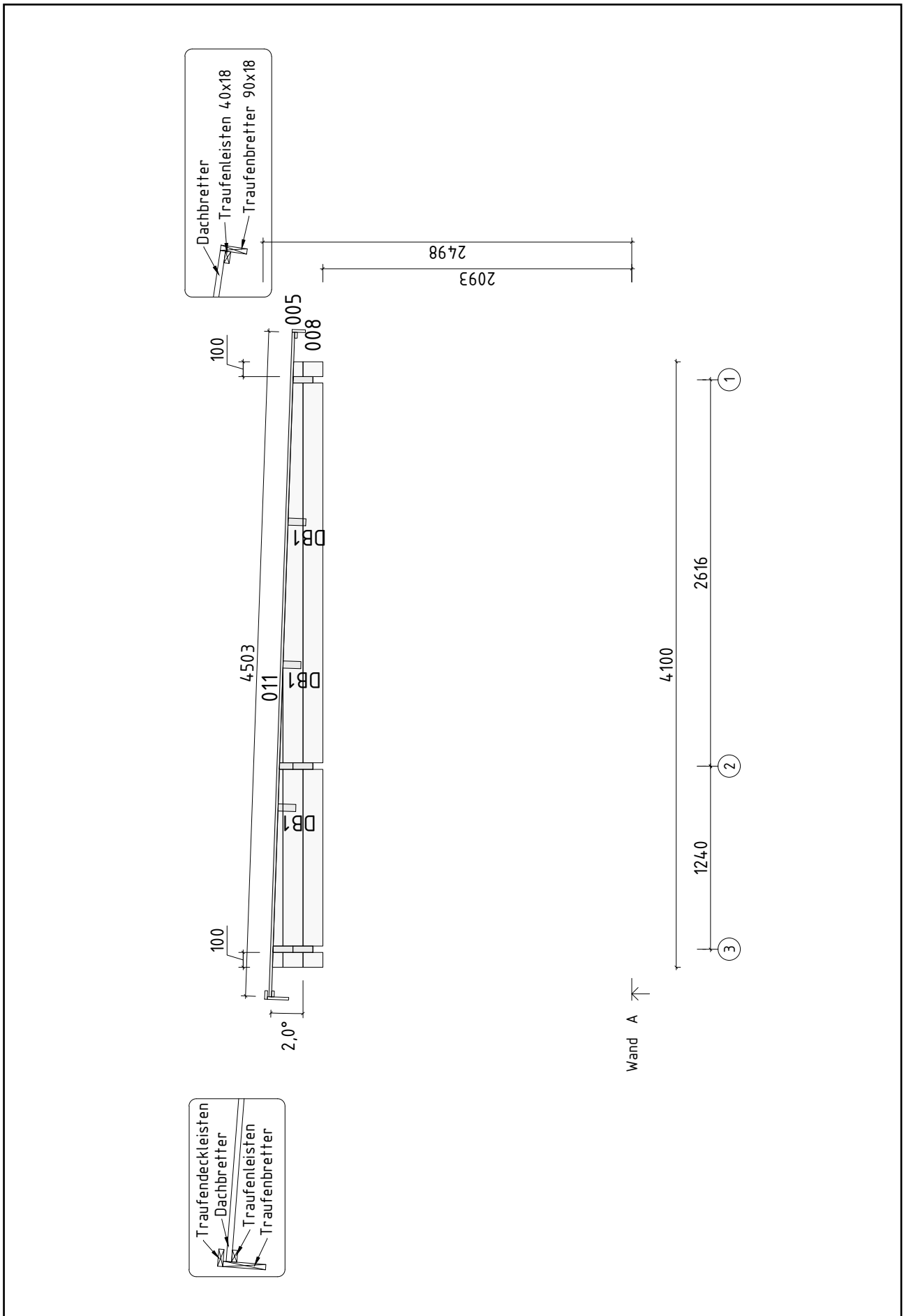

# Wandplan B und C 845170 Flachdach

