

# Technische Daten: Art.-Nr.: 846200

Wandaußenmaß: 360 x 300 cm

Bohlenstärke: 44 mm



Trondheim 70-D XL

Kontrolliert durch:

Empty box for signature or name.

Achtung: Alle angegebenen Maße sind ca.-Maße!

# 3D-Darstellung und Grundriss 846200

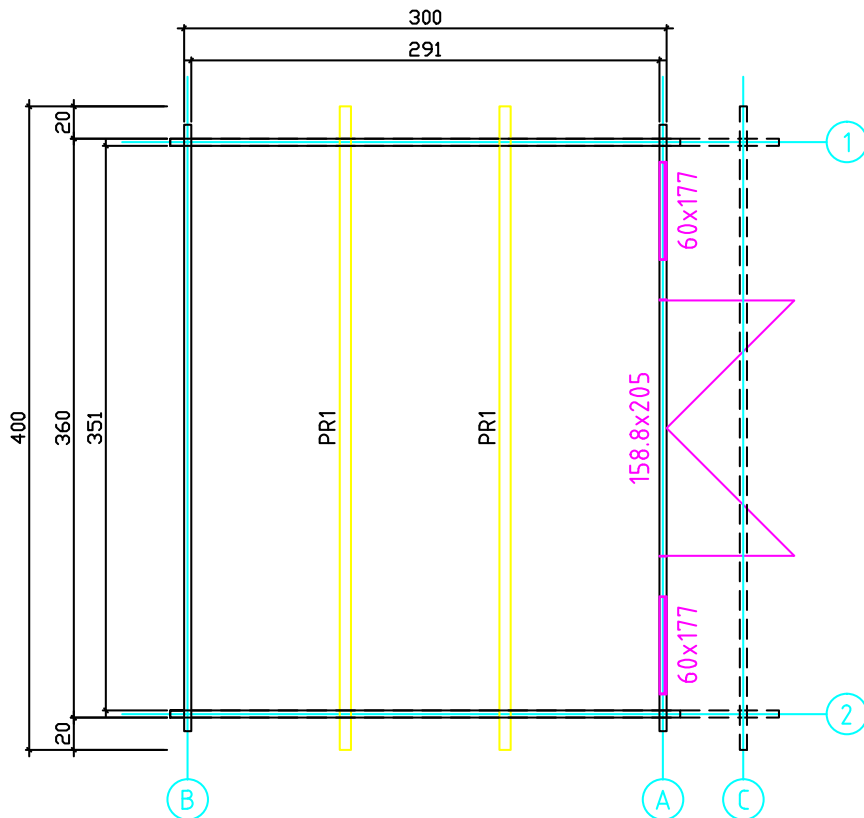
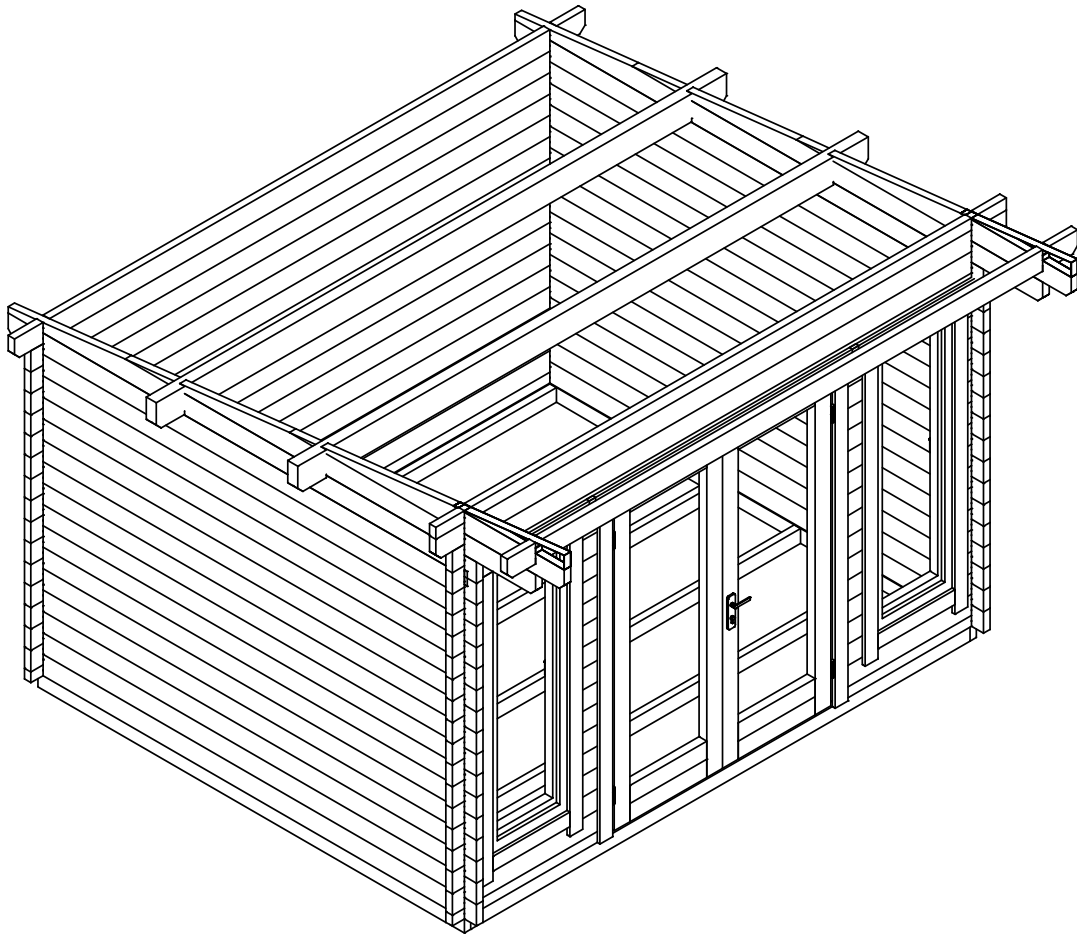





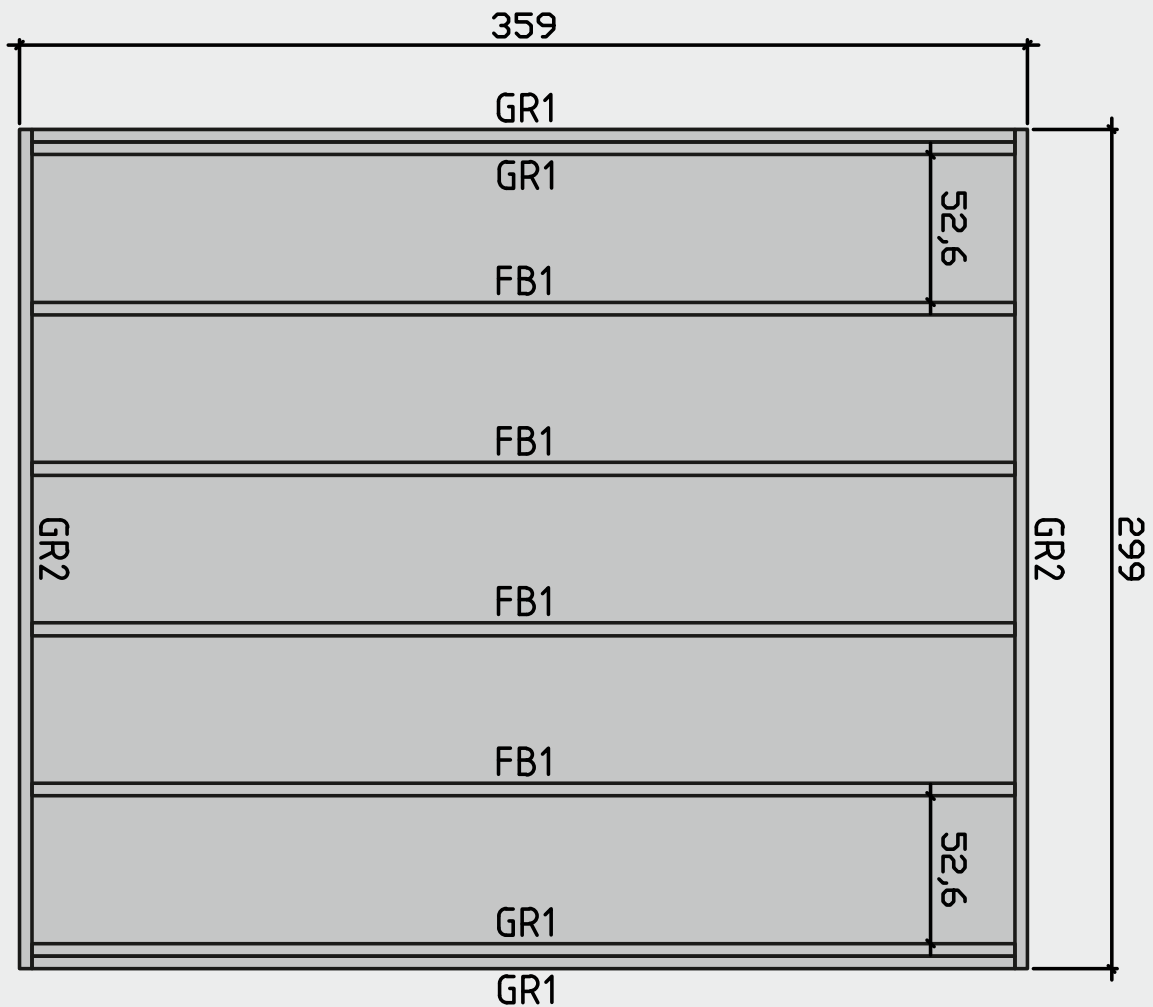





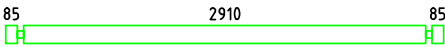
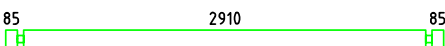

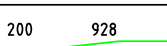
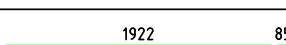
# Lagerholzplan und Fundamentplan 846200

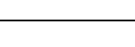
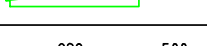
Wir empfehlen als Fundament für Ihr Gartenhaus eine vollflächig festgegründete, gepflasterte oder betonierte Fläche.  
Wahlweise ist auch ein Punkt- oder Streifenfundament möglich.

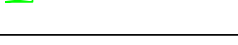
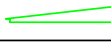
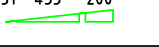
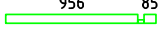
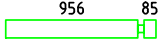

# Teileliste 1

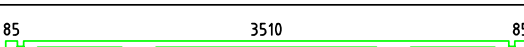
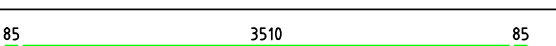
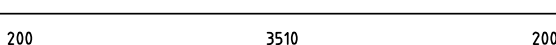
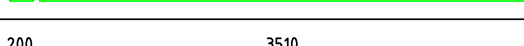
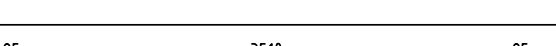
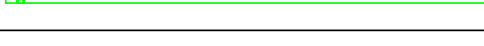
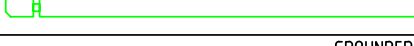
## 846200

Pos		Quantity	Profil (mm)	Lenght (mm)
001		2	45x130	3170
002		28	45x130	3170
003		2	45x130	3285
004		2	45x130	1173
005		2	45x130	2052
006		2	45x40	352
007		2	45x130	963
008		2	45x130	1473
009		2	45x22	194
010		2	45x130	1703
011		2	45x88	776
012		2	45x65	1086
013		2	45x130	1086
014		2	45x130	1086
015		26	45x130	230
016		26	45x130	246
017		1	45x130	3770
018		16	45x130	3770
019		1	45x130	4000
020		1	45x74	4000
021		1	45x65	3770
022		2	45x130	4000
GR1	GROUNDFRAME 	4	45x90	3500
GR2	GROUNDFRAME 	2	45x90	2990
FB1	FLOORBEAMS 	4	45x90	3500



# Teileliste 3

## 846200

POS	ST.	B	H	L	Teileliste		
FB1	Vt. spetsi					FUNDMENTHOLZER	
F1	10,2m <sup>2</sup>	28		2905		FUSSBODENBRETTER	
PR	2	70	170	4000		DACHBALKEN	
RB1	15,7m <sup>2</sup>	20		3925		DACHBRETTER	
R1	2	20	140	4040	<small>Vozlo kafise kalenirka</small>	Trafenbretter	
R2	2	45	65	4000	<small>Vozlo kafise kalenirka</small>	Trafenbretter	
R3	2	20	140	4120	<small>Vozlo kafise kalenirka</small>	Giebelabschlussleiste	
R4	2	20	90	4120		Giebelabschlussleiste	
DR1 WN1	1 2	1588 600	2050 1770				
P1	14m	20	40			Fußbodenleiste	
P2	1+1	20	90	3500		Türleiste DR1, Fensterleiste WN1	
P3	2+2	20	90	2030		Türleiste DR1	
P4	4+4	20	90	1920		Fensterleiste WN1	
P5	2+2	20	90	540 <del>570</del>		Fensterleiste WN1	

# Wandplan 1 und 2 846200

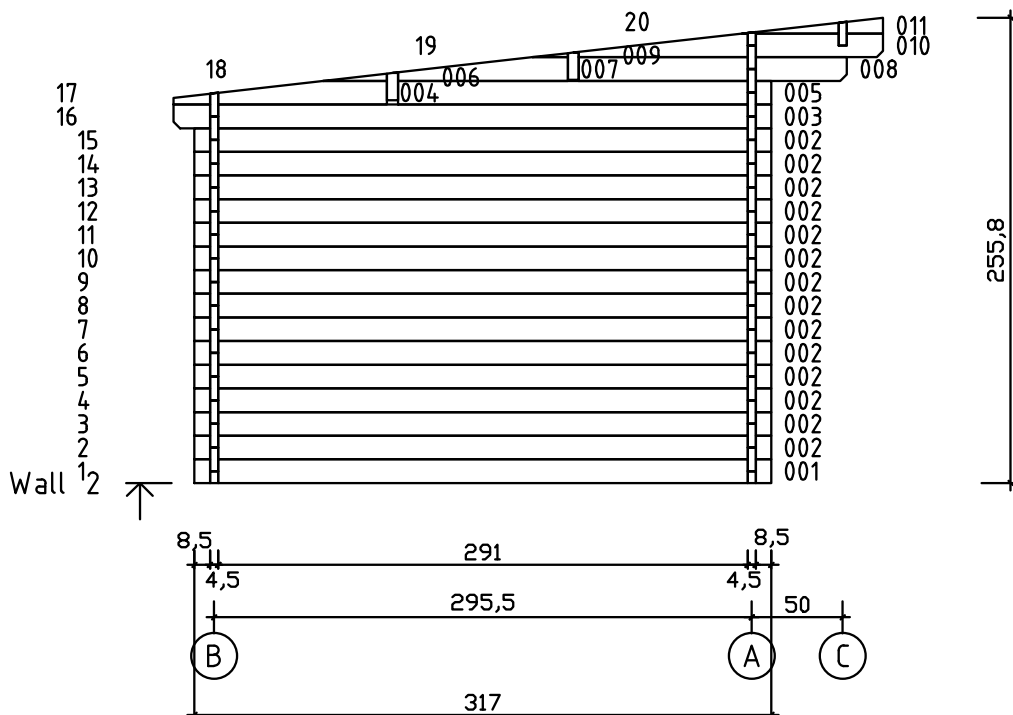
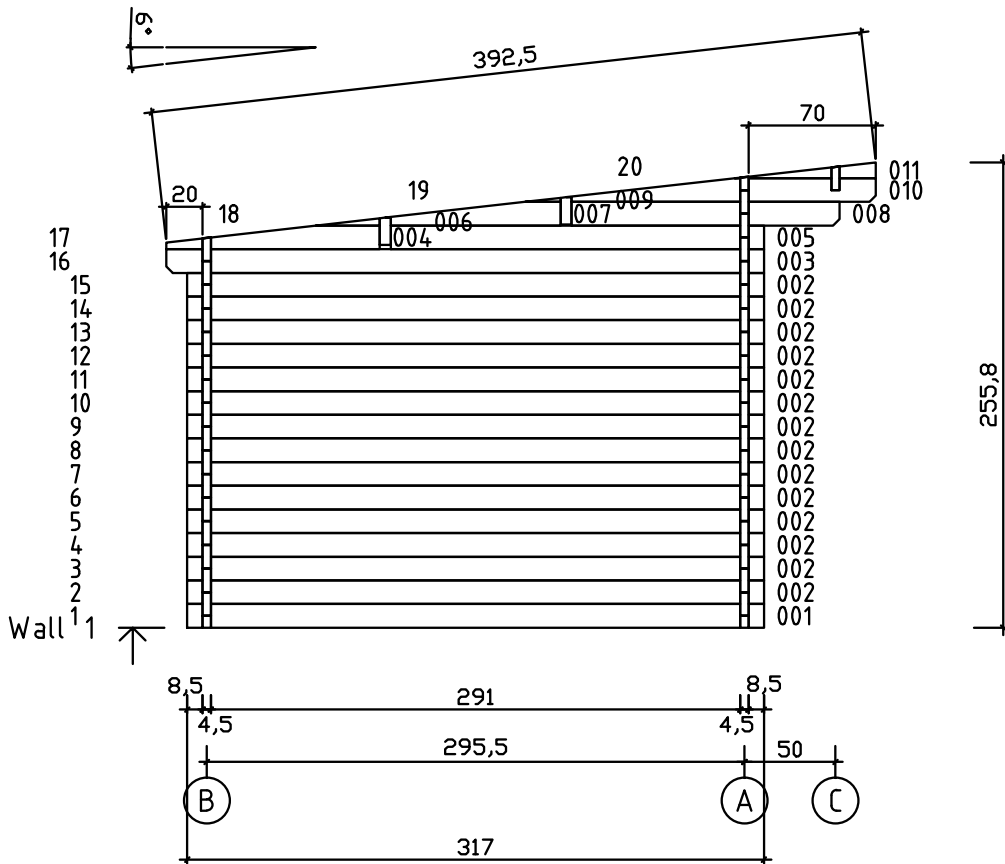

# Wandplan A und B 846200

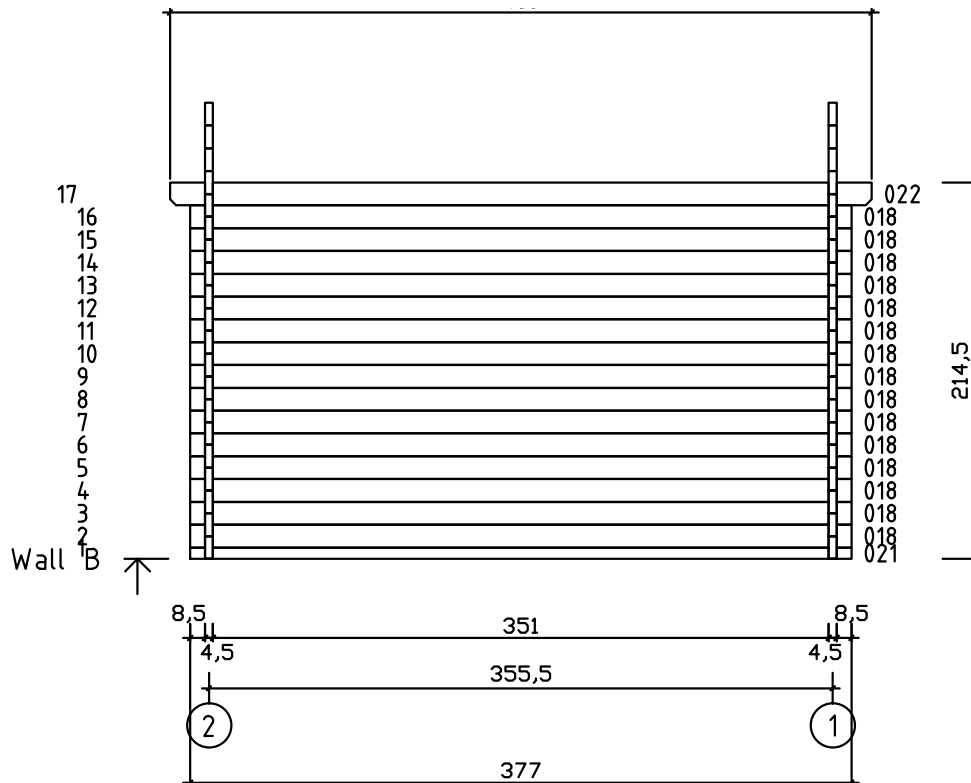
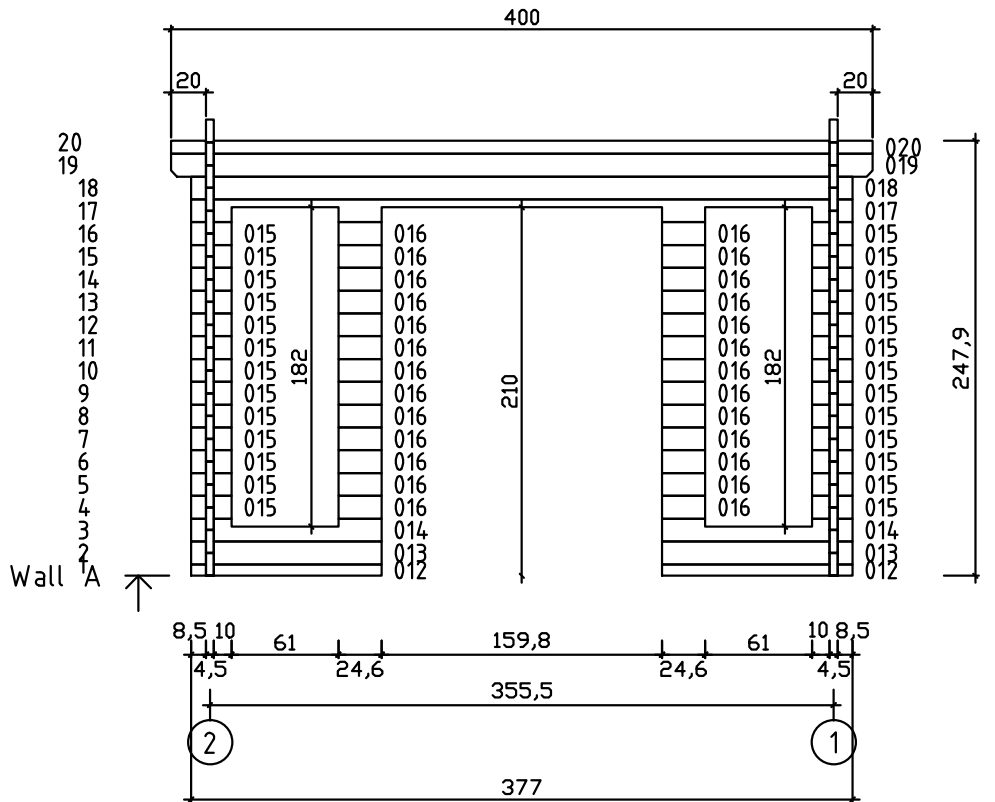



# Wandplan C 846200

