

Technische Daten: Art.-Nr.: 846210

Wandaußenmaß: 360 x 360 cm

Bohlenstärke: 44 mm



Kontrolliert durch:

Empty rectangular box for signature or stamp.





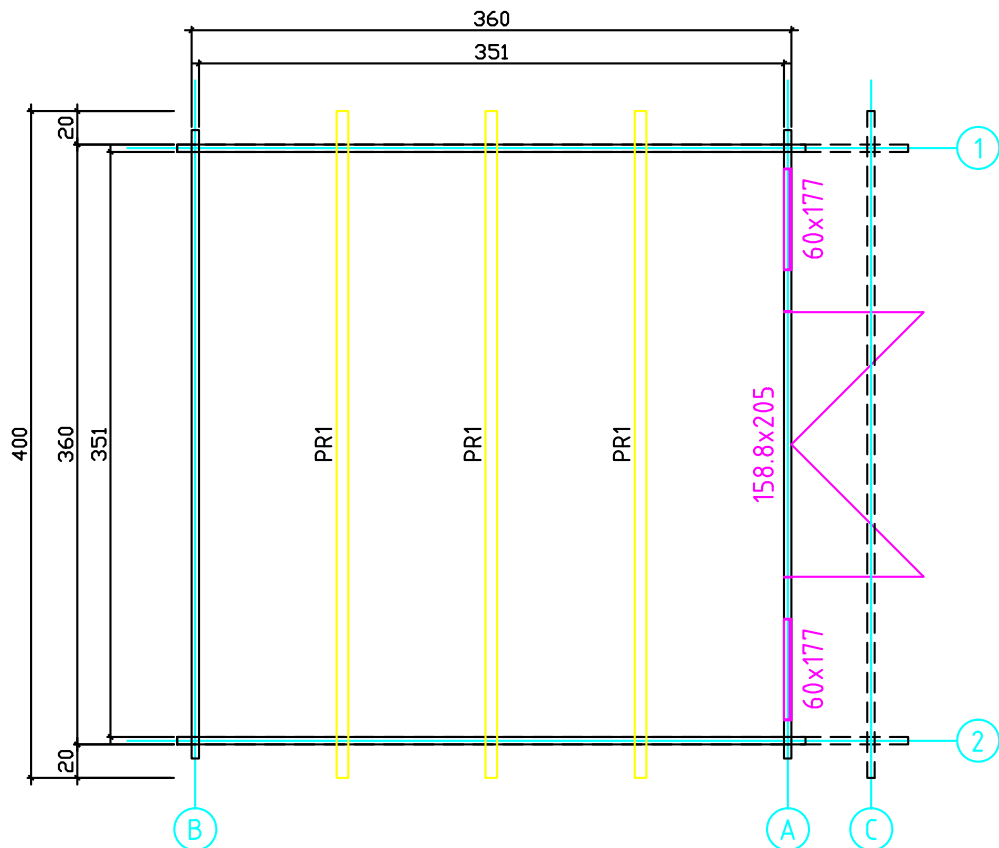
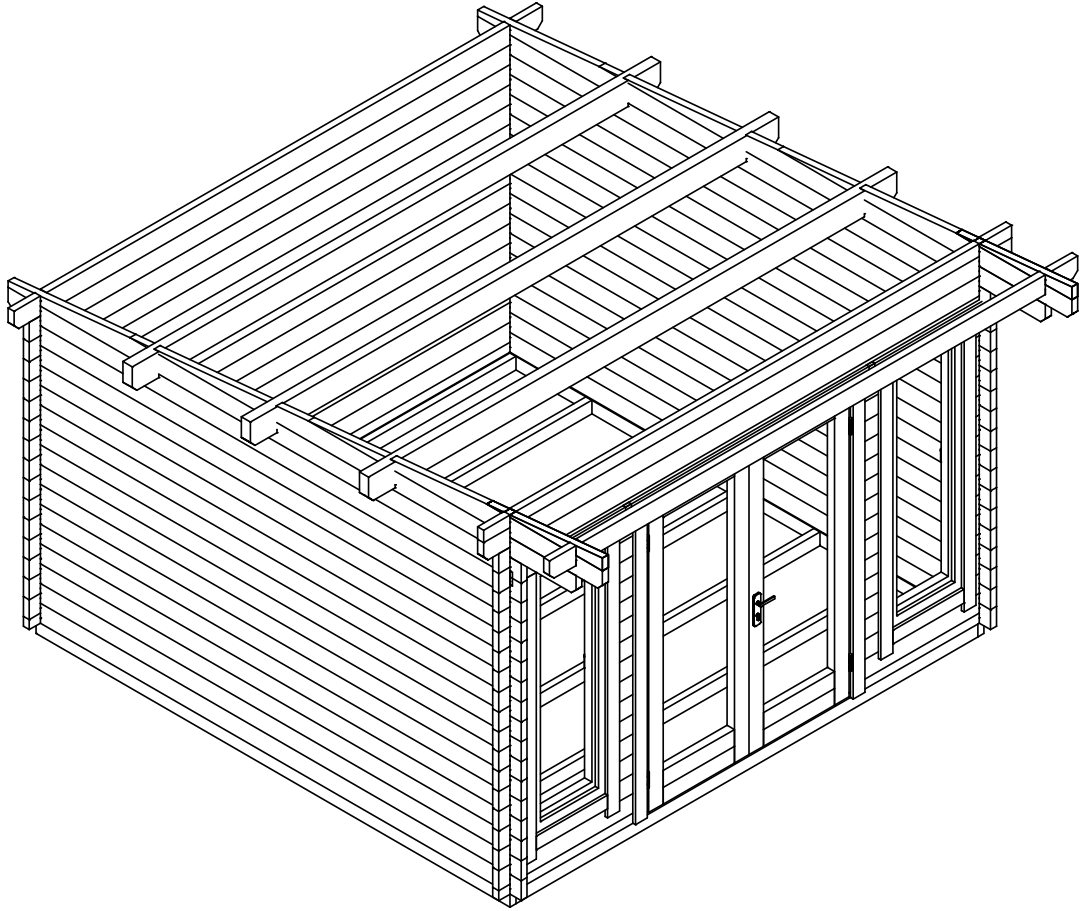

Achtung: Alle angegebenen Maße sind ca.-Maße!

3D-Darstellung und Grundriss 846210

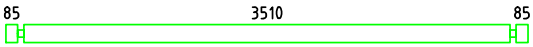
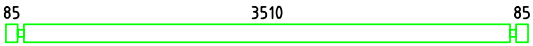
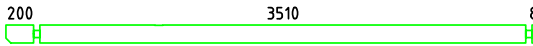
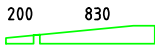
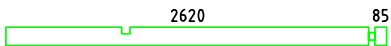

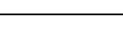
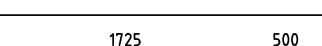
Teileliste 1

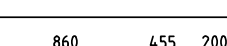
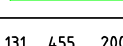
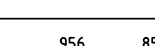
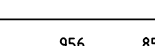
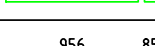
846210

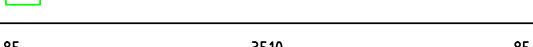
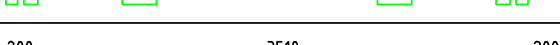
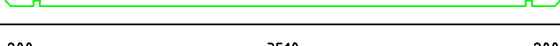
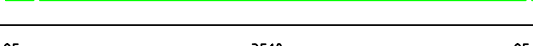
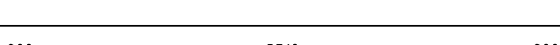
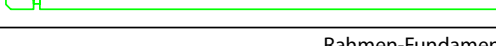
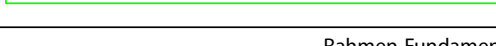
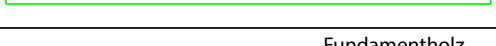
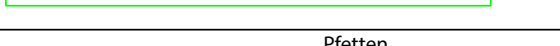
Pos		Quantity	Profil (mm)	Lenght (mm)
001		2	45x130	3770
002		44	45x130	3770
003		2	45x130	3885
004		2	45x130	1075
005		2	45x130	2750
006		2	45x15	154
007		2	45x101	865
008		2	45x130	2270
009		2	45x57	593
010		2	45x130	1605
011		2	45x84	876
012		2	45x65	1086
013		2	45x130	1086
014		2	45x130	1086
015		26	45x130	230
016		26	45x130	246
017		1	45x130	3770
018		1	45x130	4000
019		1	45x82	4000
020		1	45x65	3770
021		2	45x130	4000
GR2	Rahmen-Fundamentholz 	2	45x90	3590
GR1	Rahmen-Fundamentholz 	4	45x90	3500
FB1	Fundamentholz 	5	45x90	3500
PR1	200 3510 Pfetten 200 	3	70x170	4000

Teileliste 3

846210

POS	ST.	B	H	L	
FB1	Vt. spetsi				FUNDMENTHOLZER
F1	12,3m ²	28		3505	FUSSBODENBRETTER
PR	3	70	170	4000	DACHBALKEN
RB1	18,1m ²	20		4521	DACHBRETTER
*R1	2	20	140	4040	Traufenbretter
*R2	2	45	45	4000	Traufenbretter
*R3	2	20	140	4720	Giebelabschlussleiste
*R4	2	20	90	4720	Giebelabschlussleiste
DR1 WN1	1 2	1588 600	2050 1770		
*P1	15m	20	40		Fußbodenleiste
*P2	1+1	20	90	3500	Türleiste DR1, Fensterleiste WN1
*P3	2+2	20	90	2030	Türleiste DR1
*P4	4+4	20	90	1920	Fensterleiste WN1
*P5	2+2	20	90	540 570	Fensterleiste WN1

*Wird als Fixlänge geliefert und muss bauseits zugeschnitten werden.

Wandplan 1 und 2 846210

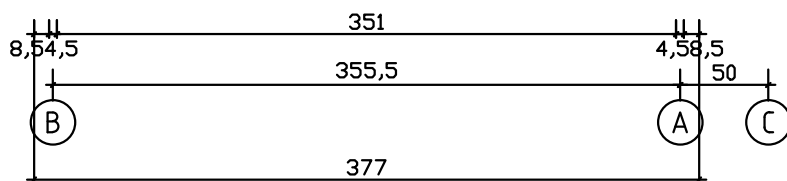
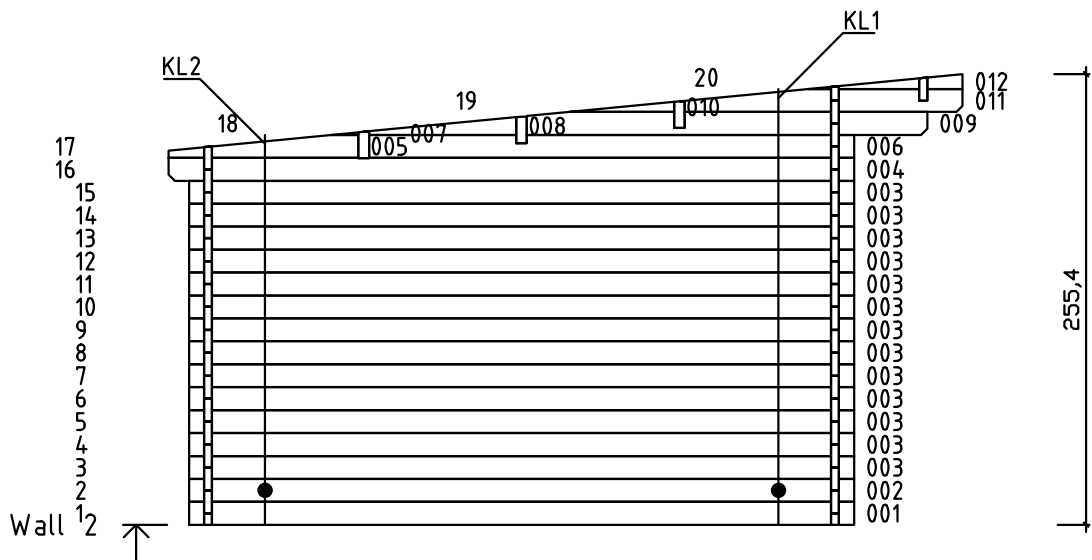
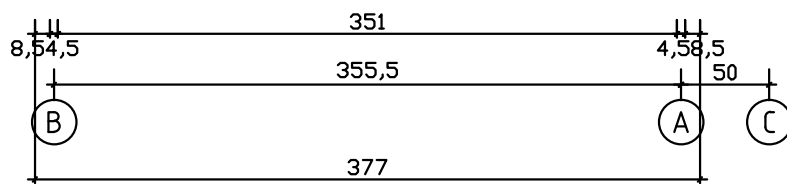
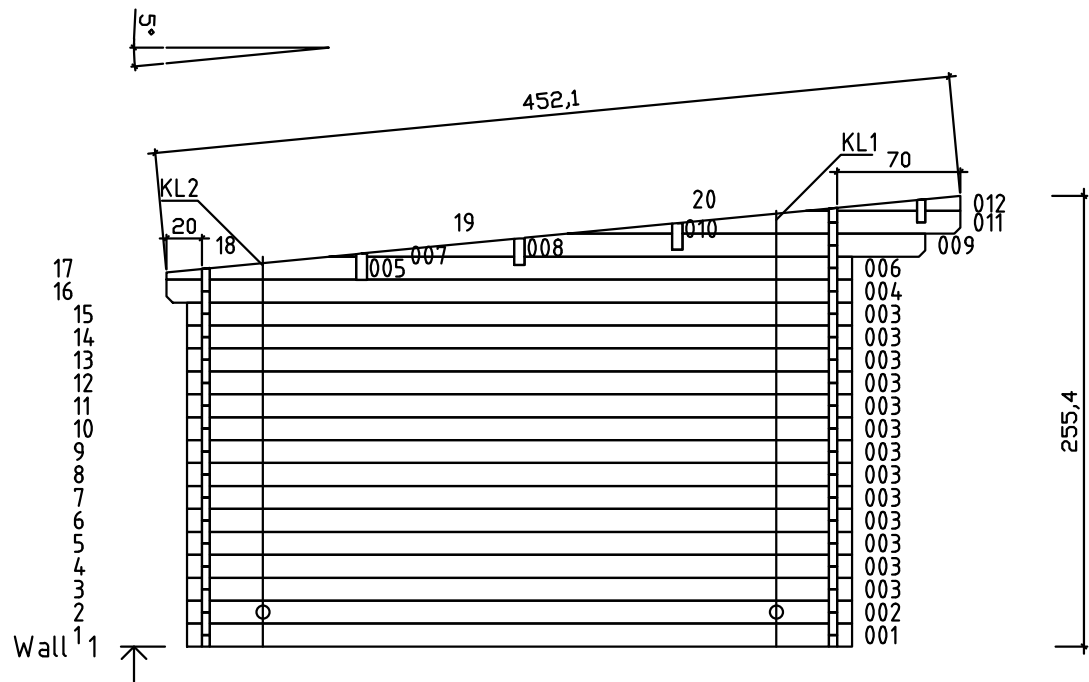

Wandplan A und B 846210

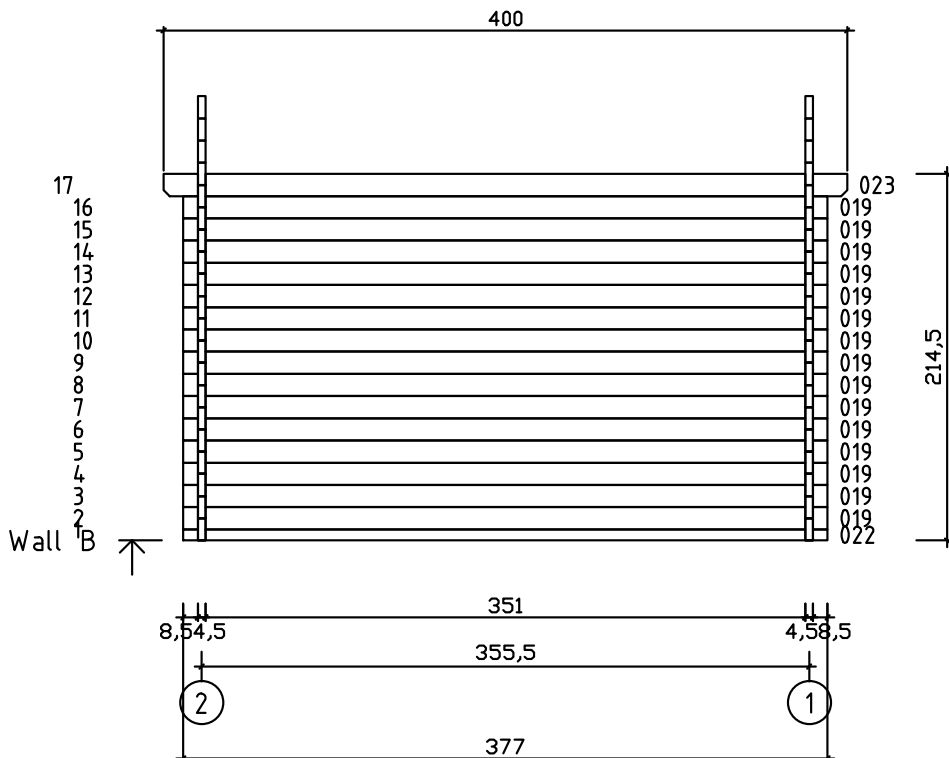
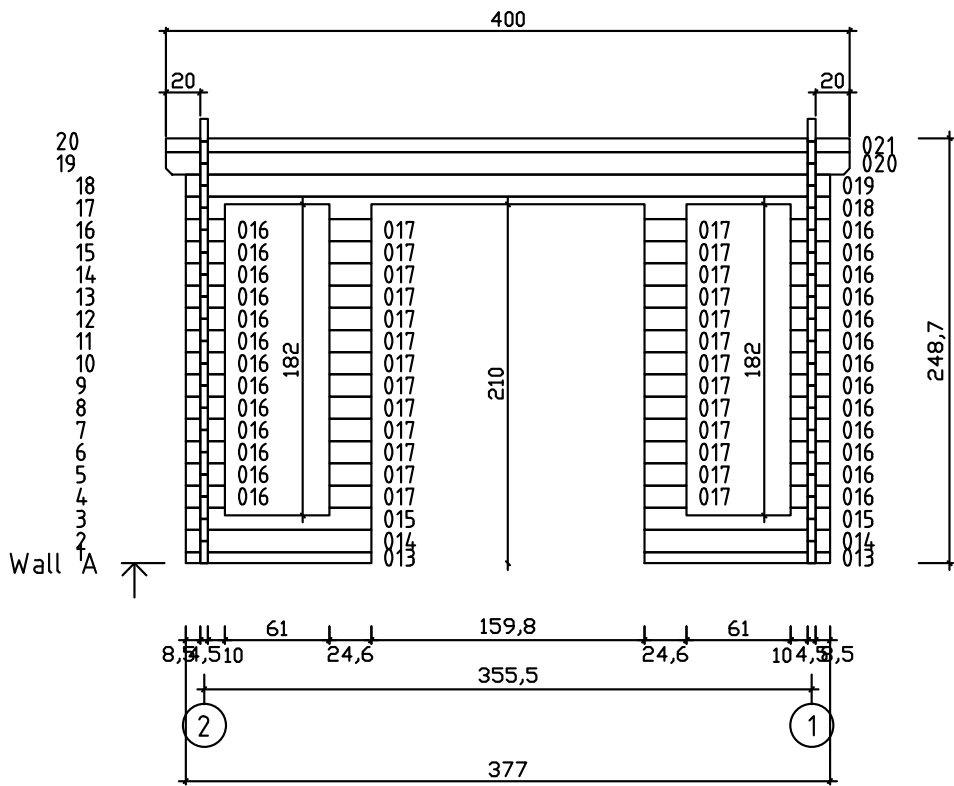

Wandplan C 846210

Vorgelagerte Vordachbohle vor Wand A

