

Technische Daten: Art.-Nr.: 846220

Wandaußenmaß: 390 x 390 cm

Bohlenstärke: 44 mm



Trondheim 70-D XL

Kontrolliert durch:

Empty box for signature or name.

Achtung: Alle angegebenen Maße sind ca.-Maße!

3D-Darstellung und Grundriss 846220

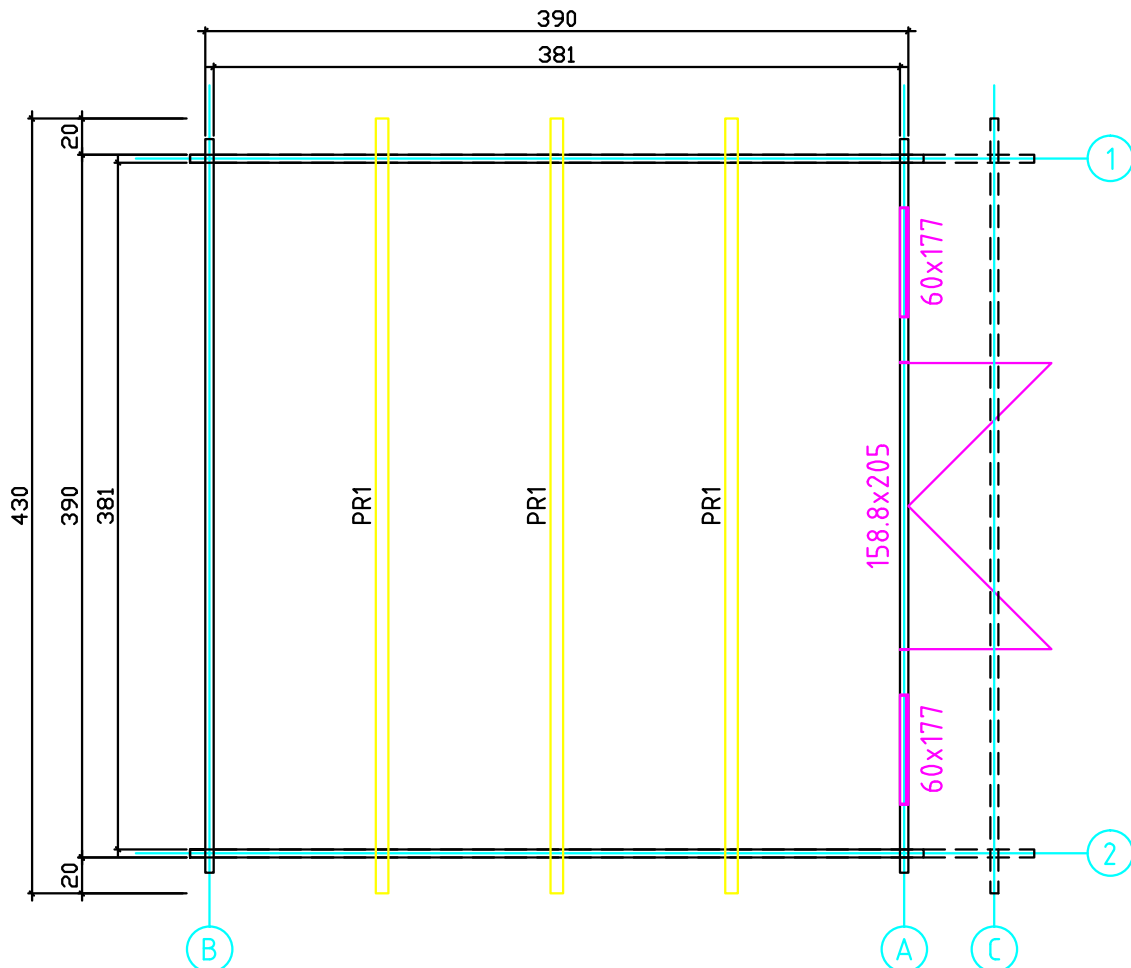
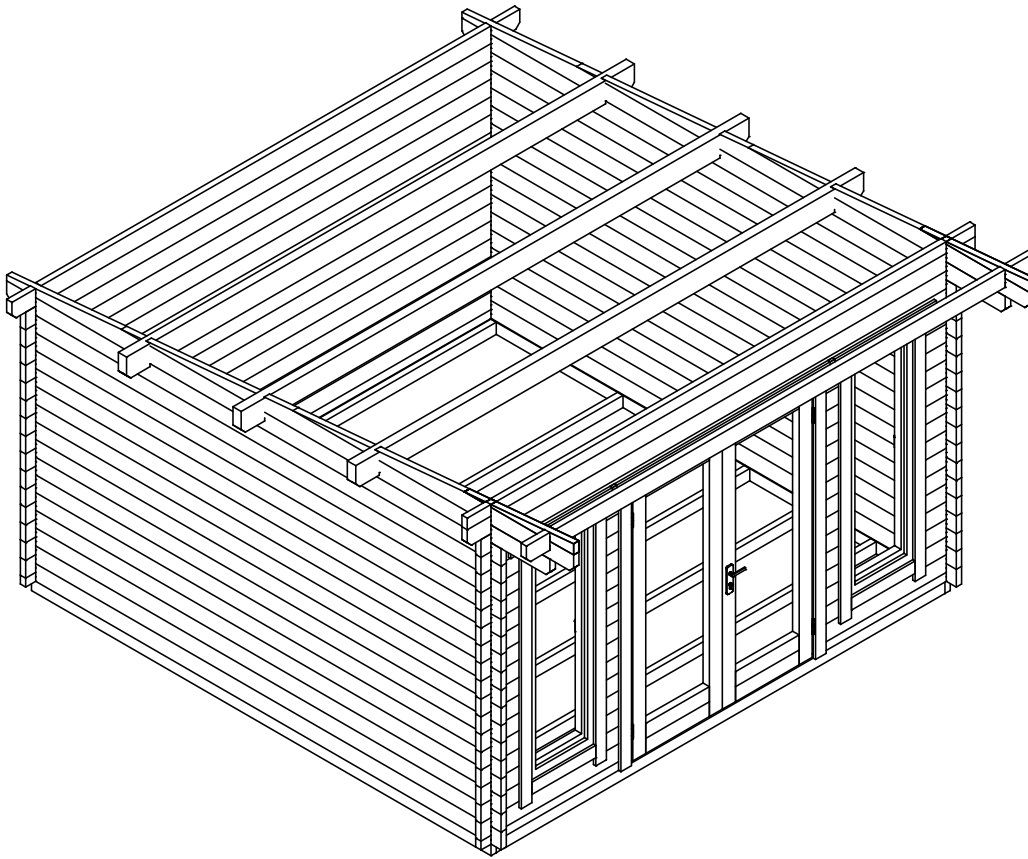

Lagerholzplan und Fundamentplan 846220

Wir empfehlen als Fundament für Ihr Gartenhaus eine vollflächig festgegründete, gepflasterte oder betonierte Fläche.
Wahlweise ist auch ein Punkt- oder Streifenfundament möglich.

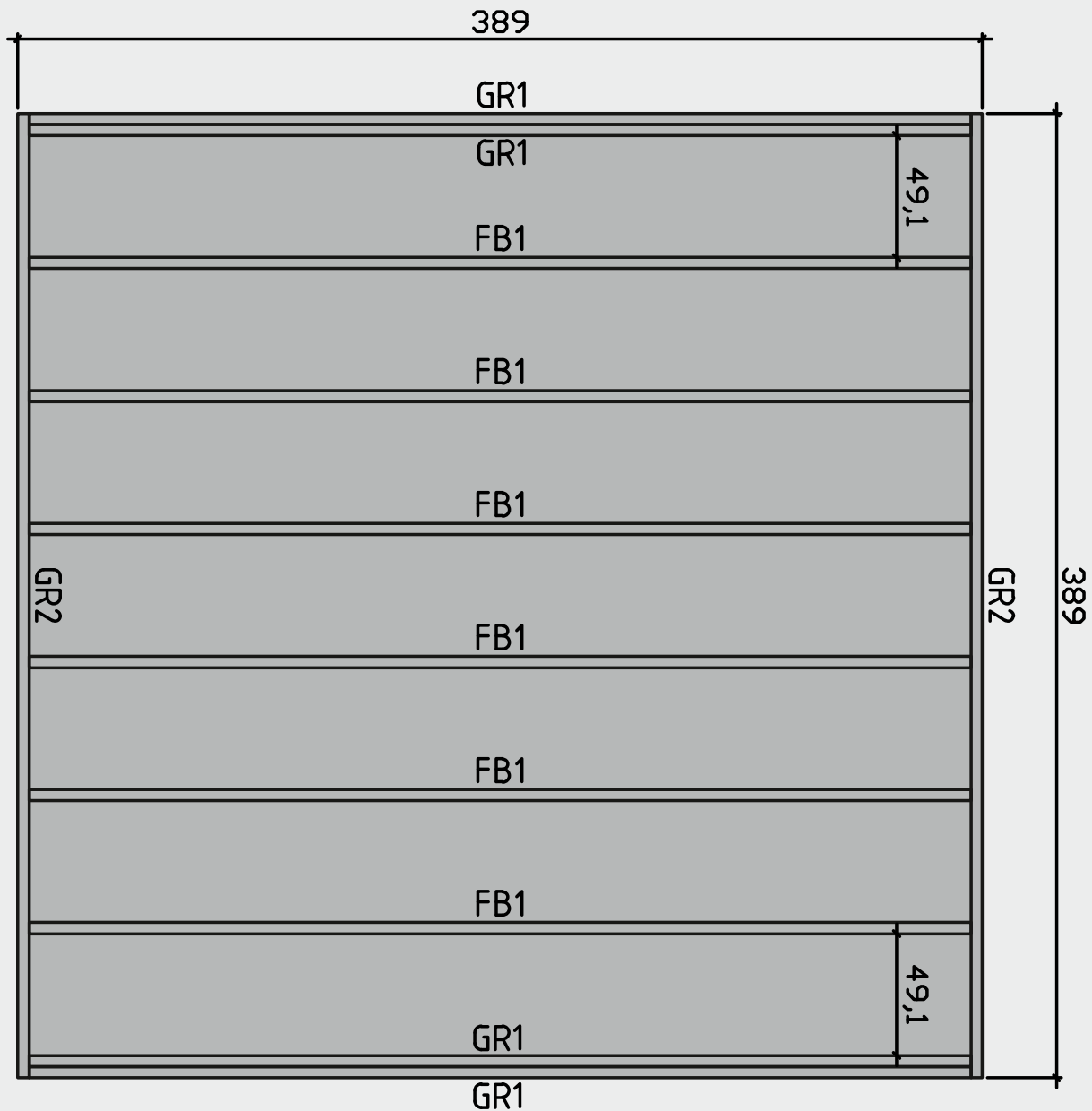











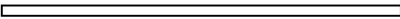







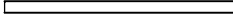

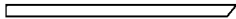
Teileliste 1

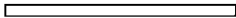
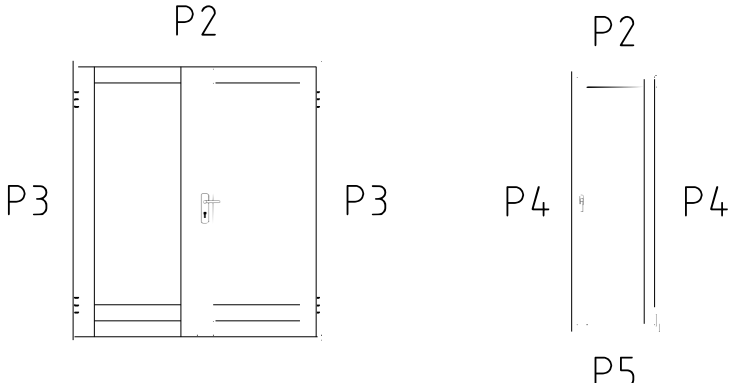
846220

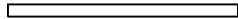
Pos		Quantity	Profil (mm)	Lenght (mm)
001		2	45x130	4070
002		44	45x130	4070
003		2	45x130	4185
004		2	45x130	1150
005		2	45x130	2975
006		2	45x16	179
007		2	45x103	940
008		2	45x130	2420
009		2	45x60	668
010		2	45x130	1680
011		2	45x83	926
012		2	45x65	1236
013		2	45x130	1236
014		2	45x130	1236
015		26	45x130	378
016		26	45x130	248
017		1	45x130	4070
018		1	45x130	4300
019		1	45x85	4300
020		1	45x65	4070
021		2	45x130	4300
GR2		2	45x90	3890
GR1		4	45x90	3800
FB1		6	45x90	3800
PR1		3	70x170	4300

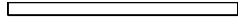
Teileliste 3

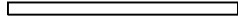
846220

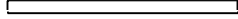
POS	ST.	B	H	L	Teileliste		
FB1	Vt. spetsi					FUNDMENTHOLZER	
F1	14,5m ²	28		3805		FUSSBODENBRETTER	
PR	3	70	170	4300		DACHBALKEN	
RB1	20,7m ²	20		4819		DACHBRETTER	
*R1	2	20	140	4340	Vaata katuse kaldeurka 	Traufenbretter	
*R2	2	45	45	4300	Vaata katuse kaldeurka 	Traufenbretter	
*R3	2	20	140	5020	Vaata katuse kaldeurka 	Giebelabschlussleiste	
*R4	2	20	90	5020		Giebelabschlussleiste	
DR1 WN1	1 2	1588 600	2050 1770				
*P1	17m	20	40			Fußbodenleiste	
*P2	1+1	20	90	3800		Türleiste DR1, Fensterleiste WN1	
*P3	2+2	20	90	2030		Türleiste DR1	
*P4	4+4	20	90	1920		Fensterleiste WN1	
P5	2+2	20	90	540 570		Fensterleiste WN1	

*Wird als Fixlänge geliefert und muss bauseits zugeschnitten werden.

Wandplan 1 und 2 846220

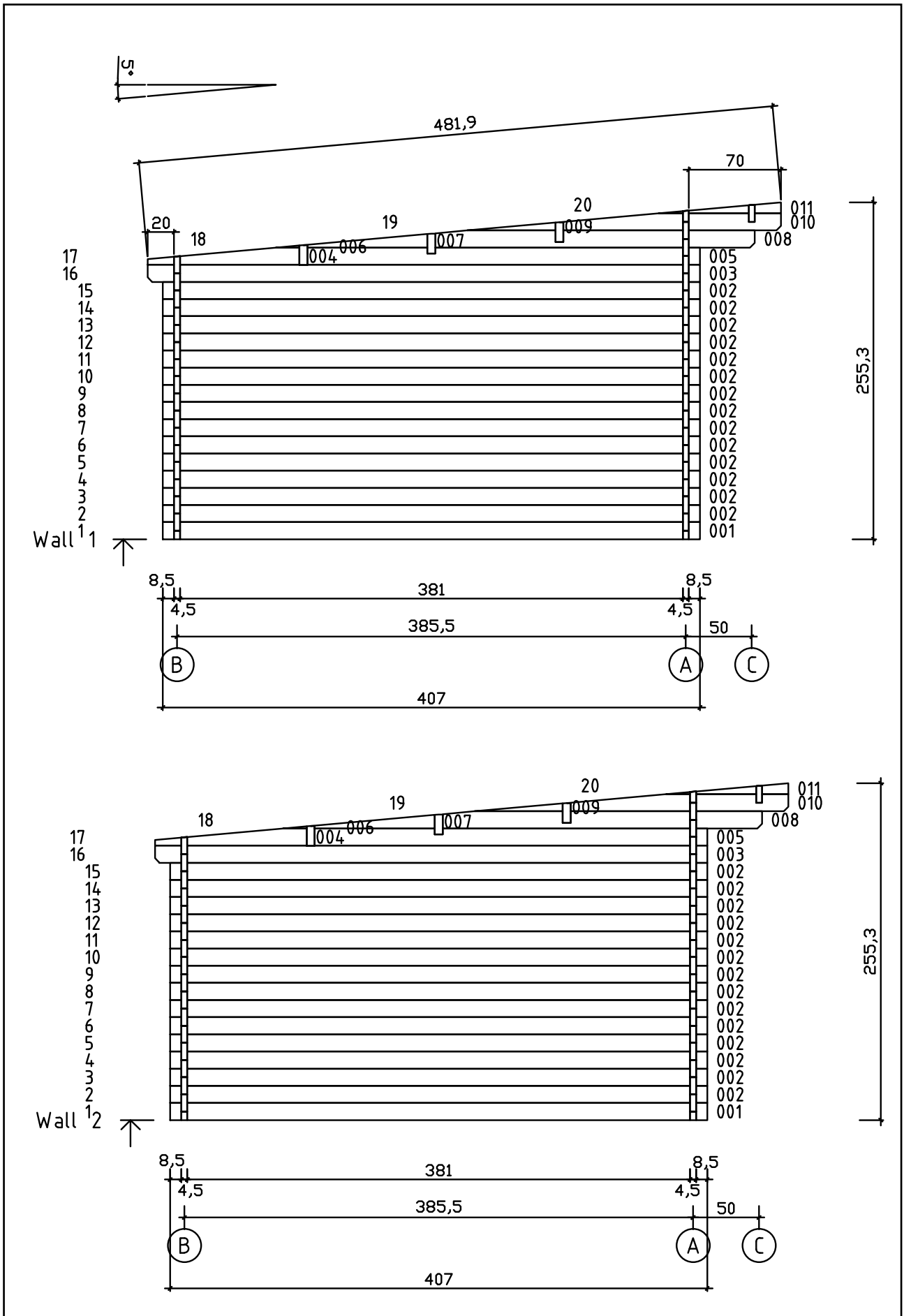

Wandplan A und B 846220

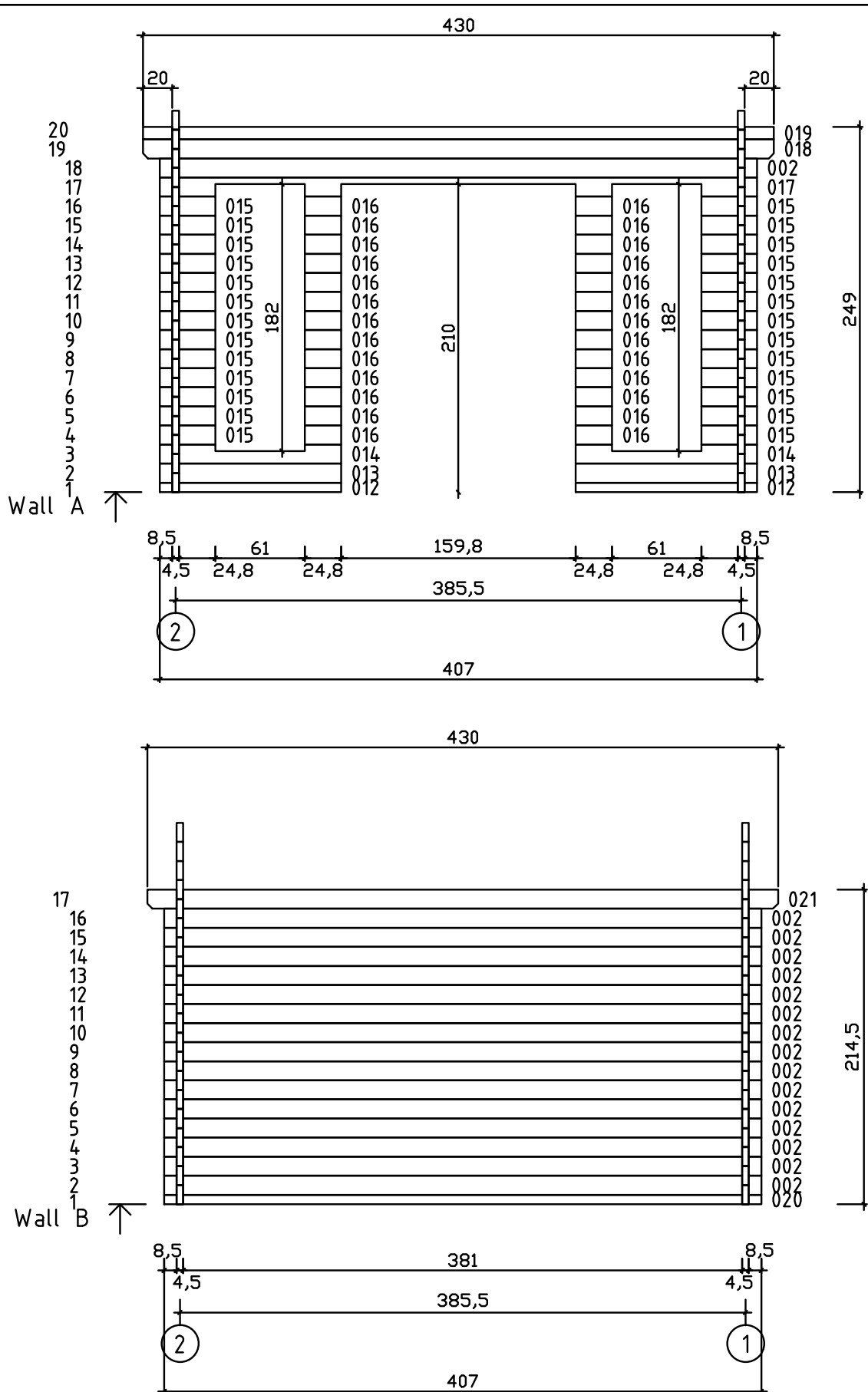

Wandplan C

846220

Vorgelagerte Vordachbohle vor Wand A

