

Technische Daten: Art.-Nr.: 846230

Wandaußenmaß: 450 x 360 cm

Bohlenstärke: 44 mm



Kontrolliert durch:

Empty box for signature or name.

Achtung: Alle angegebenen Maße sind ca.-Maße!

3D-Darstellung und Grundriss 846230

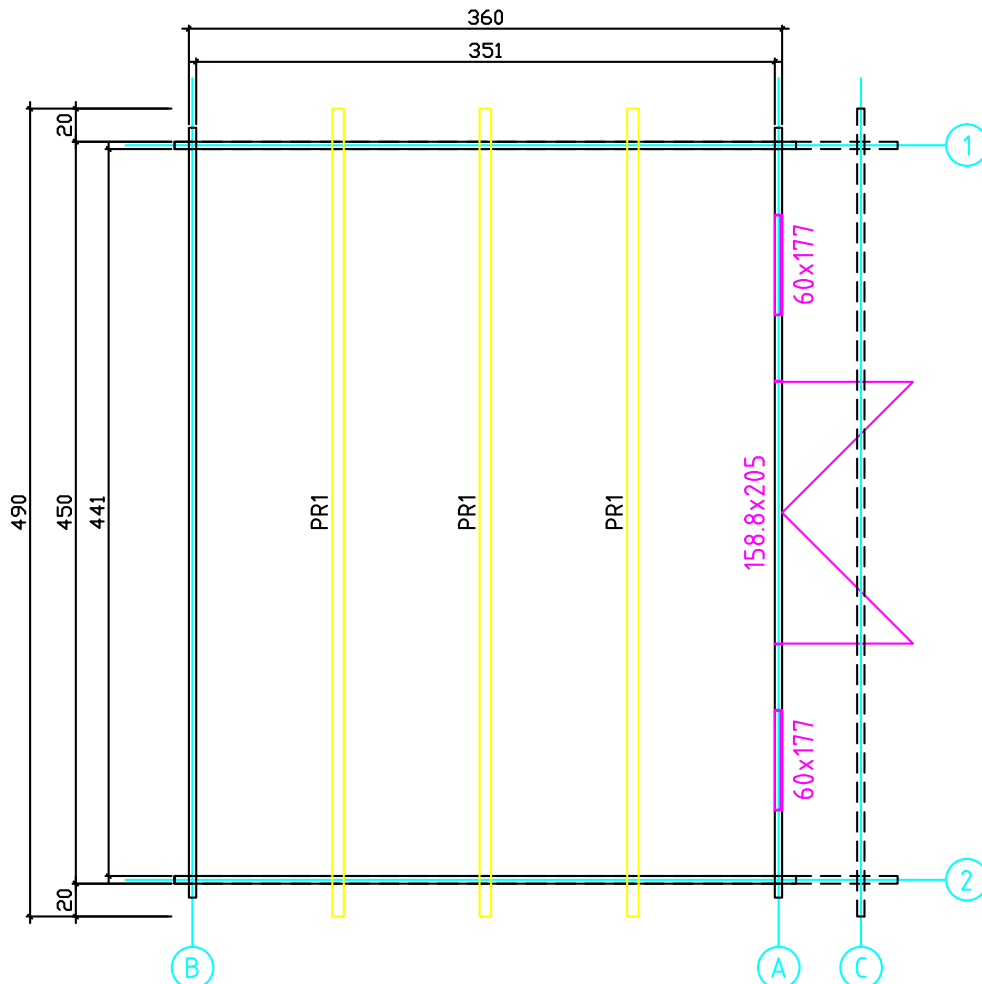
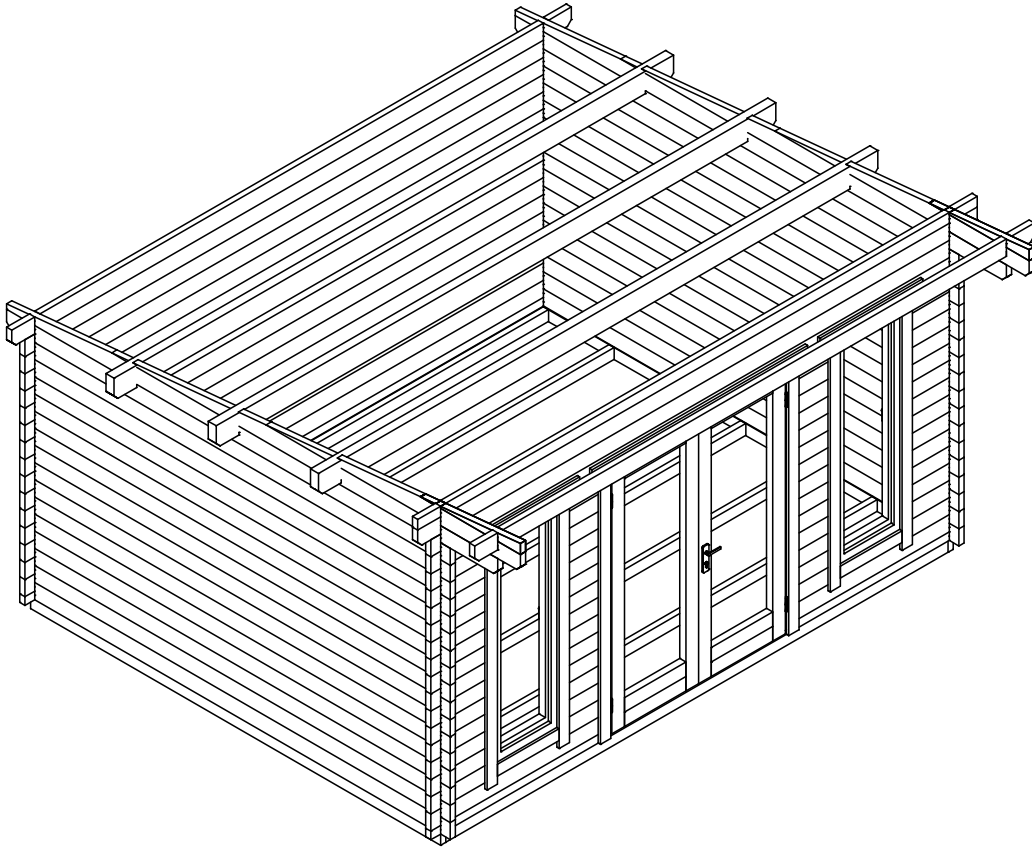





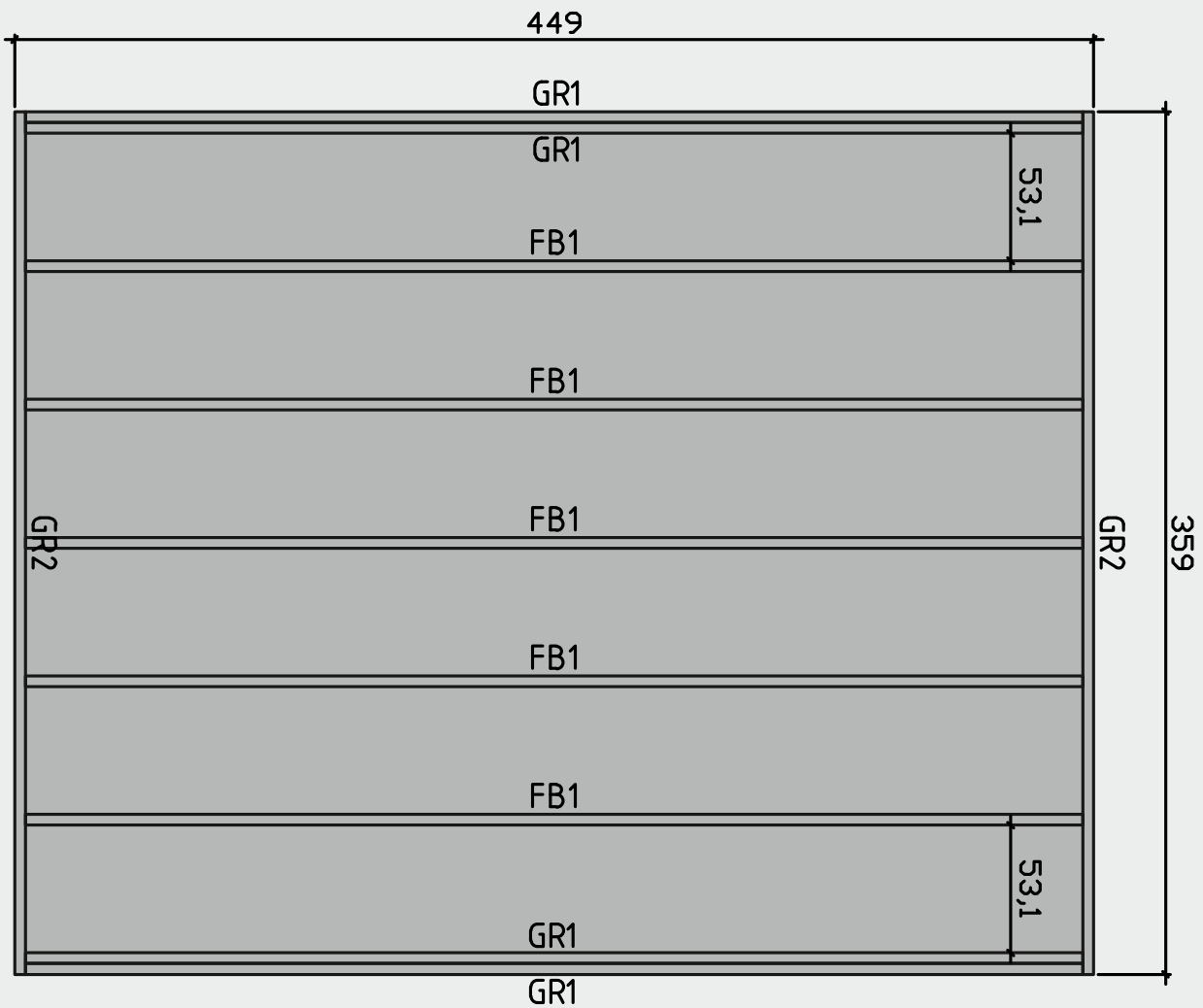

Lagerholzplan und Fundamentplan 846230

Wir empfehlen als Fundament für Ihr Gartenhaus eine vollflächig festgegründete, gepflasterte oder betonierte Fläche.
Wahlweise ist auch ein Punkt- oder Streifenfundament möglich.

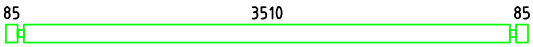
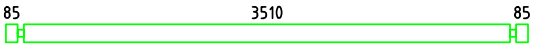
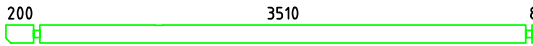
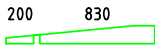
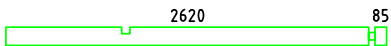

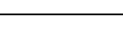
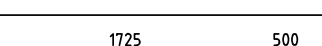
Teileliste 1

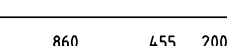
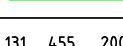
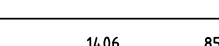
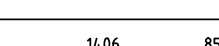
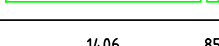
846230

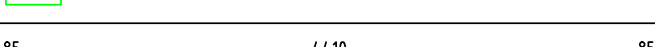
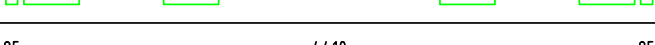
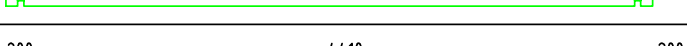
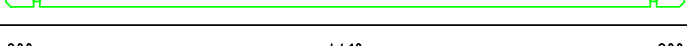
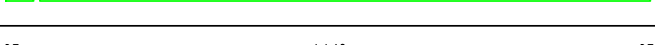
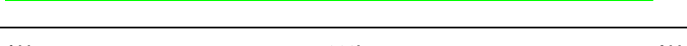
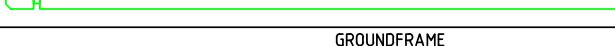
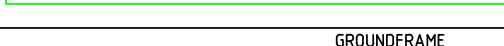
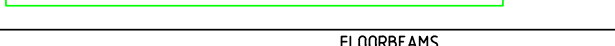
Pos		Quantity	Profil (mm)	Lenght (mm)
001		2	45x130	3770
002		28	45x130	3770
003		2	45x130	3885
004		2	45x130	1075
005		2	45x130	2750
006		2	45x15	154
007		2	45x101	865
008		2	45x130	2270
009		2	45x57	593
010		2	45x130	1605
011		2	45x84	876
012		2	45x65	1536
013		2	45x130	1536
014		2	45x130	1536
015		26	45x130	528
016		26	45x130	398
017		1	45x130	4670
018		16	45x130	4670
019		1	45x130	4900
020		1	45x82	4900
021		1	45x65	4670
022		2	45x130	4900
GR1	GROUNDFRAME 	4	45x90	4400
GR2	GROUNDFRAME 	2	45x90	3590
FB1	FLOORBEAMS 	5	45x90	4400

Teileliste 2

846230

Pos		Quantity	Profil (mm)	Lenght (mm)
PR1	<p style="text-align: center;">200 4410^{Purlins} 200</p>	3	70x170	4900
	WINDOW 600x1770	2		
	DOOR 1588x2050	1		
1	Screws/Schrauben/Vis 5x100 mm- For fixing first row of wall logs /Fixierung des ersten Bohlenkranzes/Pour fixer les lamesde plancher		6	
2	Nails/Nägel/Clous 2.5x50 - For fixing floorboards/ Befestigung Fussbodenbretter/Pour fixer les lames de plancher		350	
3	Nails/Nägel/Clous 2.5x50 - For fixing roofboards/ Befestigung Dachbretter/Pour fixer les voliges		350	
4	Nails/Nägel/Clous 2.5x50 - For fixing floor edge trims/ Befestigung Fussleisten/Pour fixer les plinthes du plancher		30	
5	Nails/Nägel/Clous 2.5x50 - For fixing roofing felt fillet/ Befestigung giebelabschlussbrett/Pour fixer la latte de finition de la couverture		30	
6	Screws/Schrauben/Vis 2,5x50 mm- For fixing roof side boards and roof edge reinforcement Befestigung Traufenbretter und Traufenleisten Pour fixer les planches de rive et le tasseau de refront		150	
7	Screws/Schrauben/Vis 2,5x50 mm- For fixing fascia boards and diamonds/ Befestigung Giebelblende und Raute Pour fixer les planches de rive et le diamant			
8	Screws/Schrauben/Vis 2,5x50 mm- For fixing fwindow and door trims/ Befestigung Fenster und türen/ Pour fixer les croissilons des fenetres et des portes			

Technische Änderungen, Druckfehler und Irrtümer vorbehalten

Var 19.02.19 / I / Original 21.11.18

Teileliste 3

846230

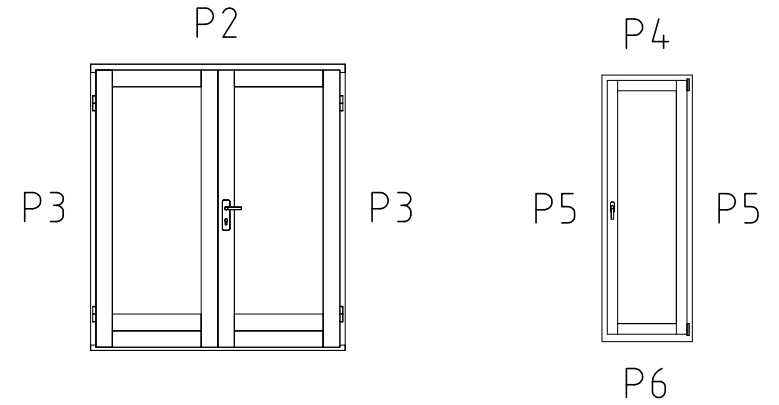
POS	ST.	B	H	L	Teileliste		
FB1	Vt. spetsi					FUNDMENTHOLZER	
F1	15,5m ²	28		3505		FUSSBODENBRETTER	
PR	3	70	170	4900		DACHBALKEN	
RB1	22,2m ²	20		4521		DACHBRETTER	
R1	2	20	140	4940	<small>Vozlo kafise kalenirka</small> 	Traufenbretter	
R2	2	45	65	4900	<small>Vozlo kafise kalenirka</small> 	Traufenbretter	
R3	2	20	140	4720	<small>Vozlo kafise kalenirka</small> 	Giebelabschlussleiste	
R4	2	20	90	4720		Giebelabschlussleiste	
DR1 WN1	1 2	1588 600	2050 1770				
P1	17m	20	40			Fußbodenleiste	
P2	1+1	20	90	1890		Türleiste DR1	
P3	2+2	20	90	2030		Türleiste DR1	
P4	2+2	20	90	900		Fensterleiste WN1	
P5	4+4	20	90	1920		Fensterleiste WN1	
P6	2+2	20	90	540 570		Fensterleiste WN1	

Wandplan 1 und 2 846230

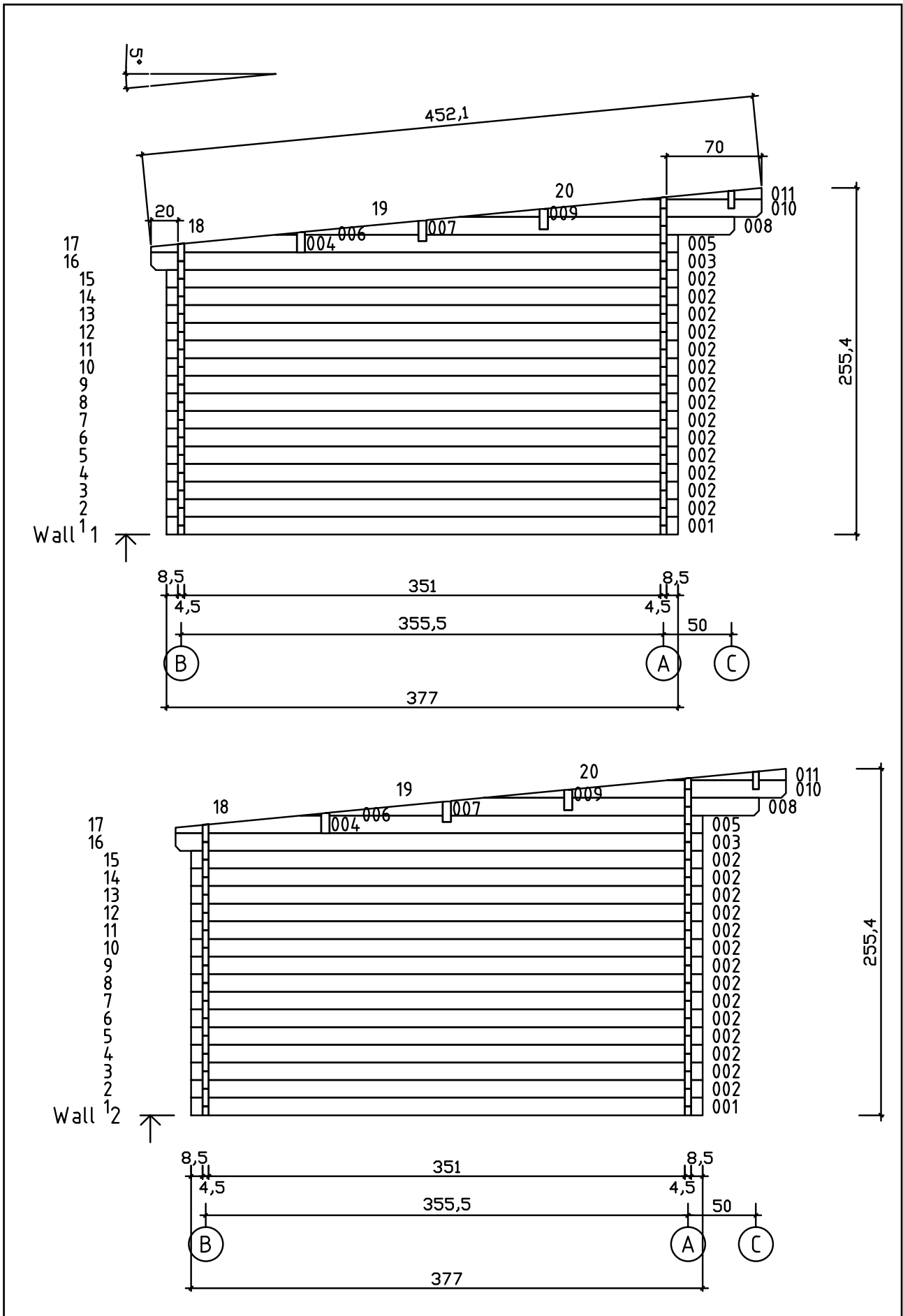

Wandplan A und B

846230

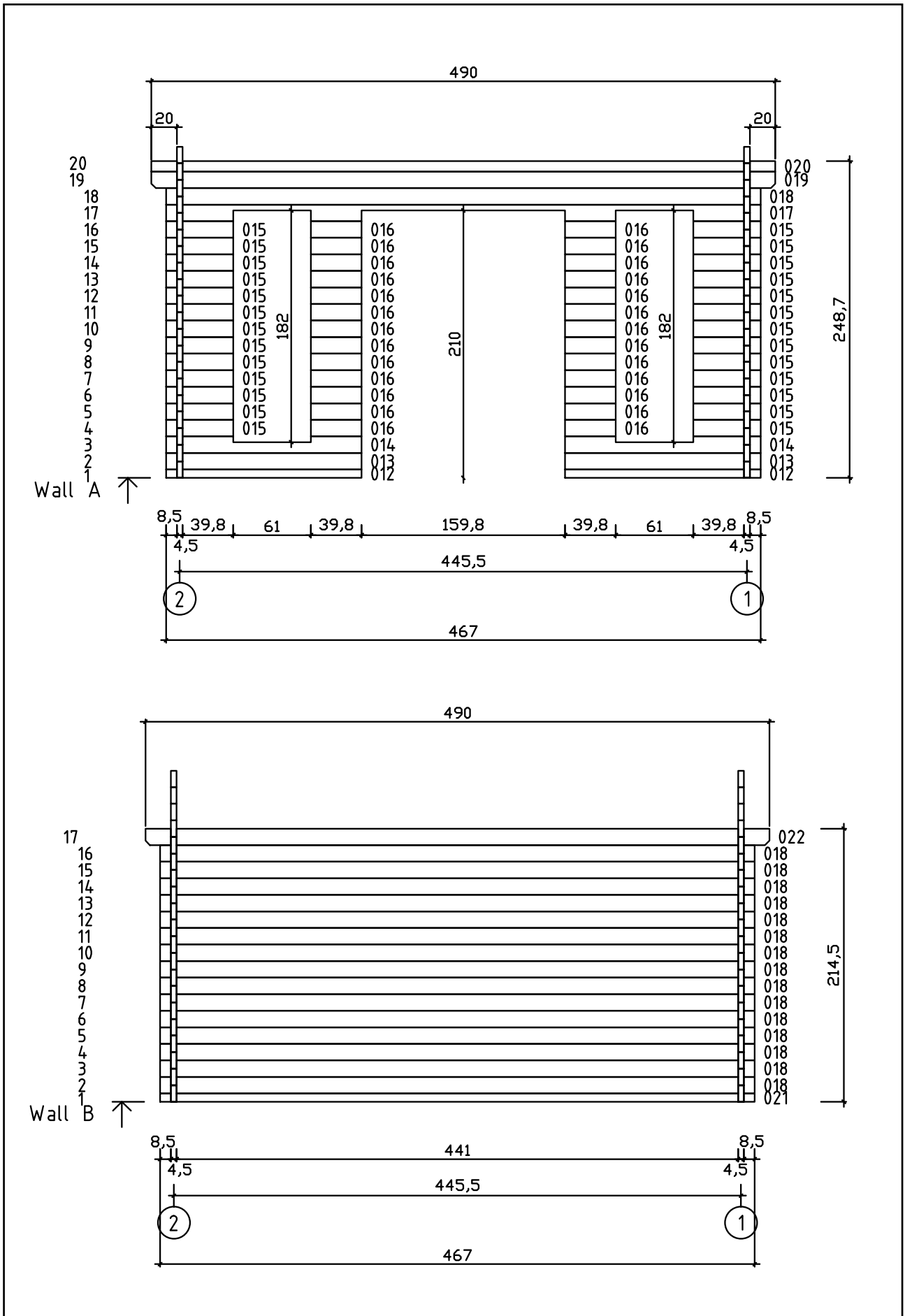

Wandplan C

846230

Vorgelagerte Vordachbohle vor Wand A

