

Technische Daten: Art.-Nr.: 846440

Wandaußenmaß: 500 x 500 cm

Bohlenstärke: 44 mm



Farblich behandelt in Gletschergrau.

Kontrolliert durch:

Empty rectangular box for signature or name.

Achtung: Alle angegebenen Maße sind ca.-Maße!

3D-Darstellung und Grundriss 846440

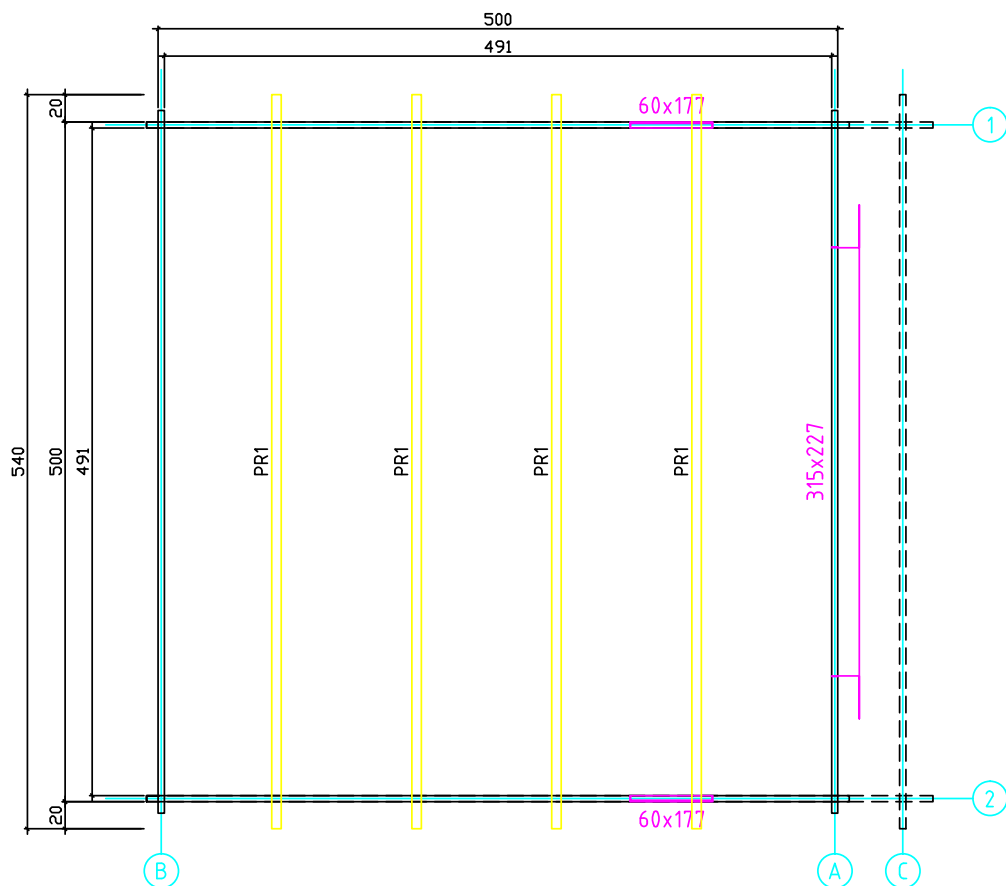
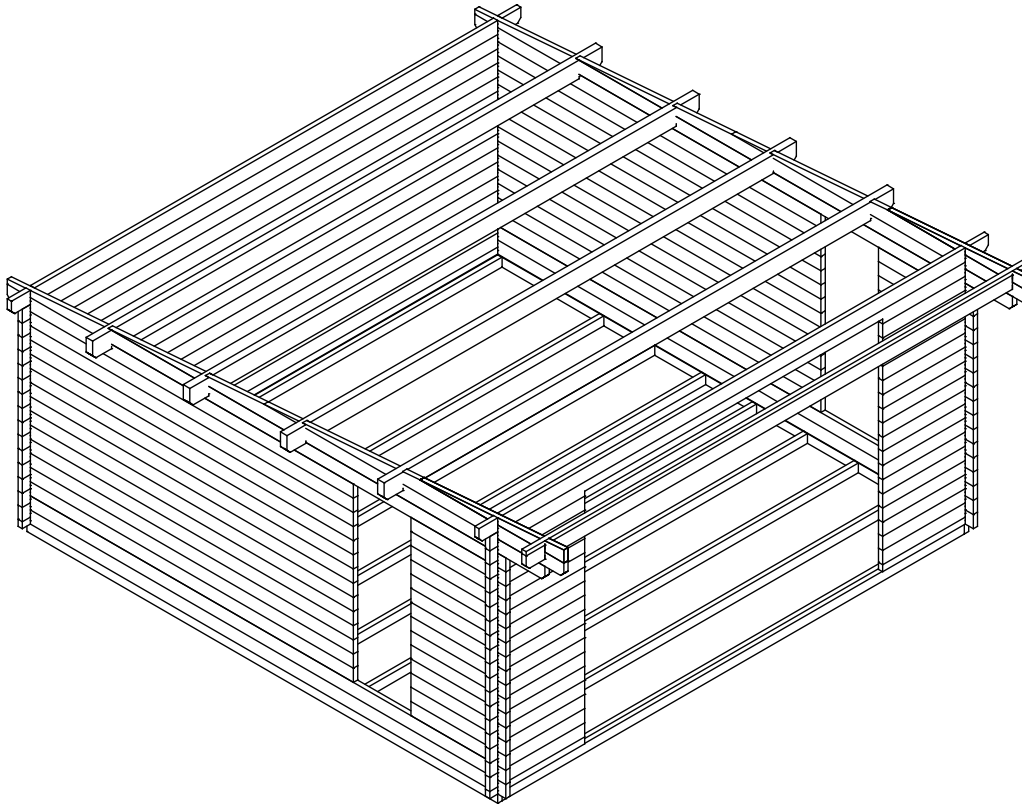





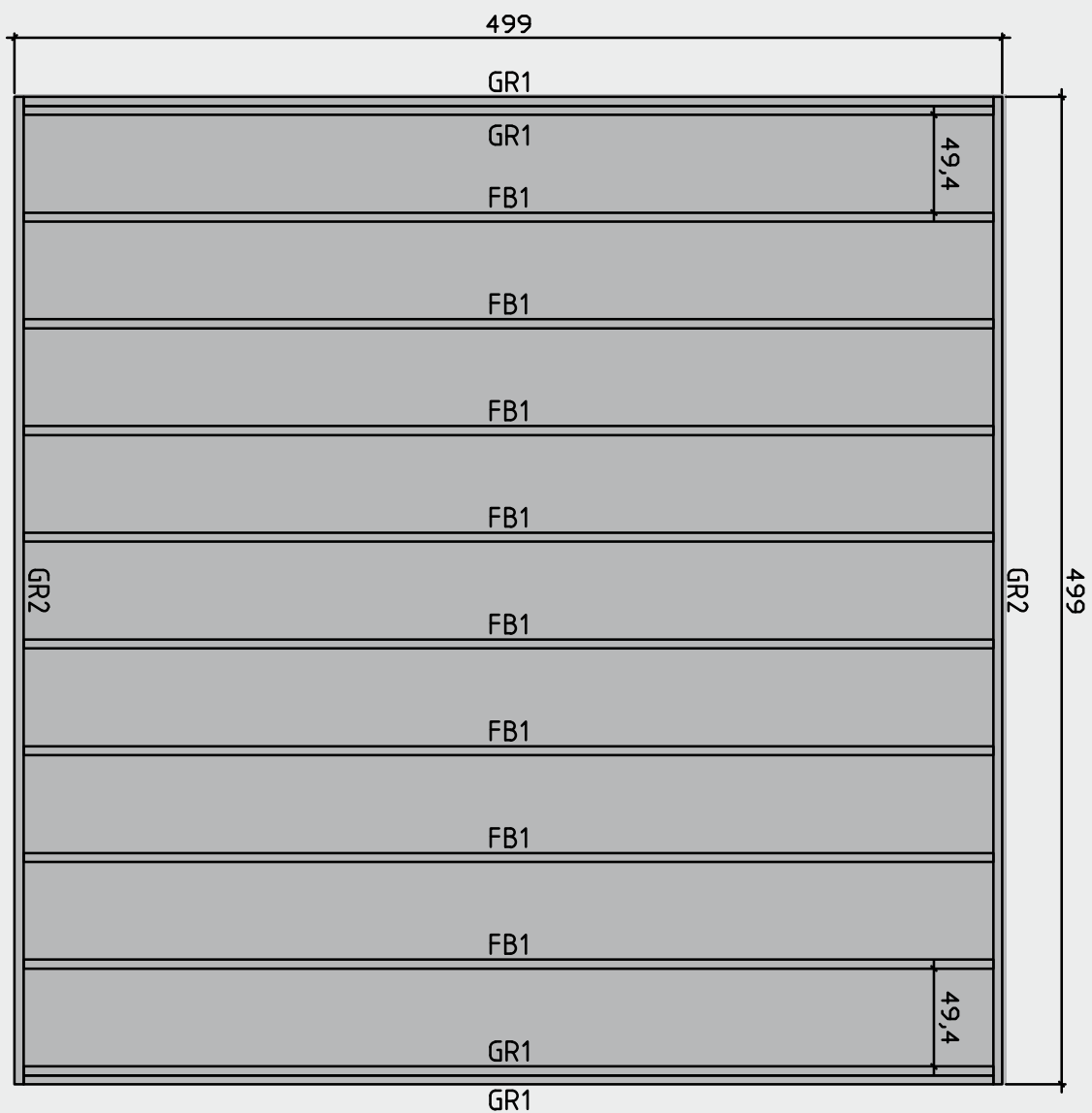

Lagerholzplan und Fundamentplan 846440

Wir empfehlen als Fundament für Ihr Gartenhaus eine vollflächig festgegründete, gepflasterte oder betonierte Fläche.
Wahlweise ist auch ein Punkt- oder Streifenfundament möglich.

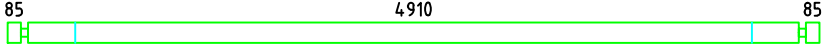
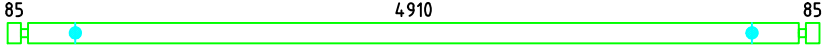
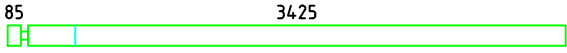
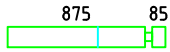
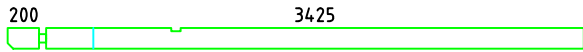
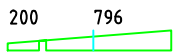
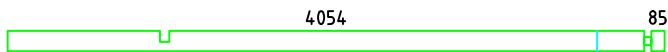

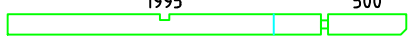
Teileliste 1

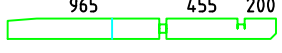
846440

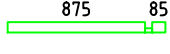
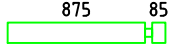
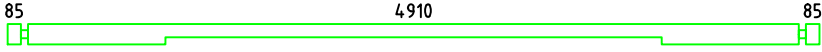
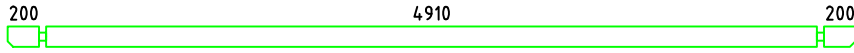
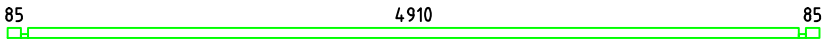
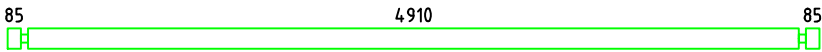
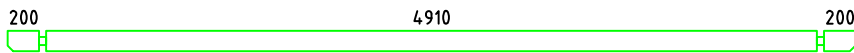
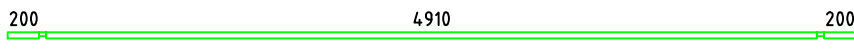
Trondheim 45-F XL		Quantity	(mm)	(mm)
	85 4910 85	2	45x130	5170
	85 4910 85	2	45x130	5170
	85 3425	26	45x130	3555
	875 85	28	45x130	1005
	200 3425	2	45x130	3670
	200 796	2	45x128	1041
	4054 85	2	45x130	4184
		2	45x79	1000
		2	45x130	1000
	1995 500	2	45x130	2540
		2	45x30	378
		2	45x111	1000
	965 455 200	2	45x130	1710
	781 455 200	2	45x120	1526
	875 85	2	45x65	1005
	875 85	34	45x130	1005
	85 4910 85	1	45x130	5170
	200 4910 200	2	45x130	5400
	85 4910 85	1	45x65	5170
	85 4910 85	15	45x130	5170
	200 4910 200	1	45x130	5400
	200 4910 200	1	45x39	5400
GROUNDFRAME				

Teileliste 3

846440

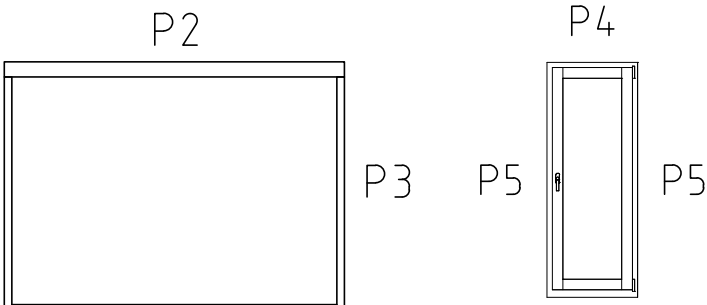
POS	ST.	B	H	L	
FB1	Vt. spetsi				FUNDMENTHOLZER
F1	24,1m ²	28		4905	FUSSBODENBRETTER
PR	4	70	170	5400	DACHBALKEN
RB1	32m ²	20		5918	DACHBRETTER
R1	2	20	140	5440	Traufenbretter
R2	2	45	45	5400	Traufenbretter
R3	4	20	140	3050	Giebelabschlussleiste
R4	4	20	90	3050	Giebelabschlussleiste
WN1	2	600	1770		 <p style="margin-top: 10px;"> 45x140x3150 mm - 1 pcs. 45x70x2130 mm - 2 pcs. 20x45x3010 mm - 1 pcs. </p>
P1	21m	20	40		Fußbodenleiste
P2	2+2	20	90	3600	Türleiste
P3	4+4	20	90	2150	Türleiste
P4	2+2	20	90	900	Fensterleiste WN1
P5	4+4	20	90	1920	Fensterleiste WN1
P6	2+2	20	90	540 570	Fensterleiste WN1

Teilleiste 4 846440

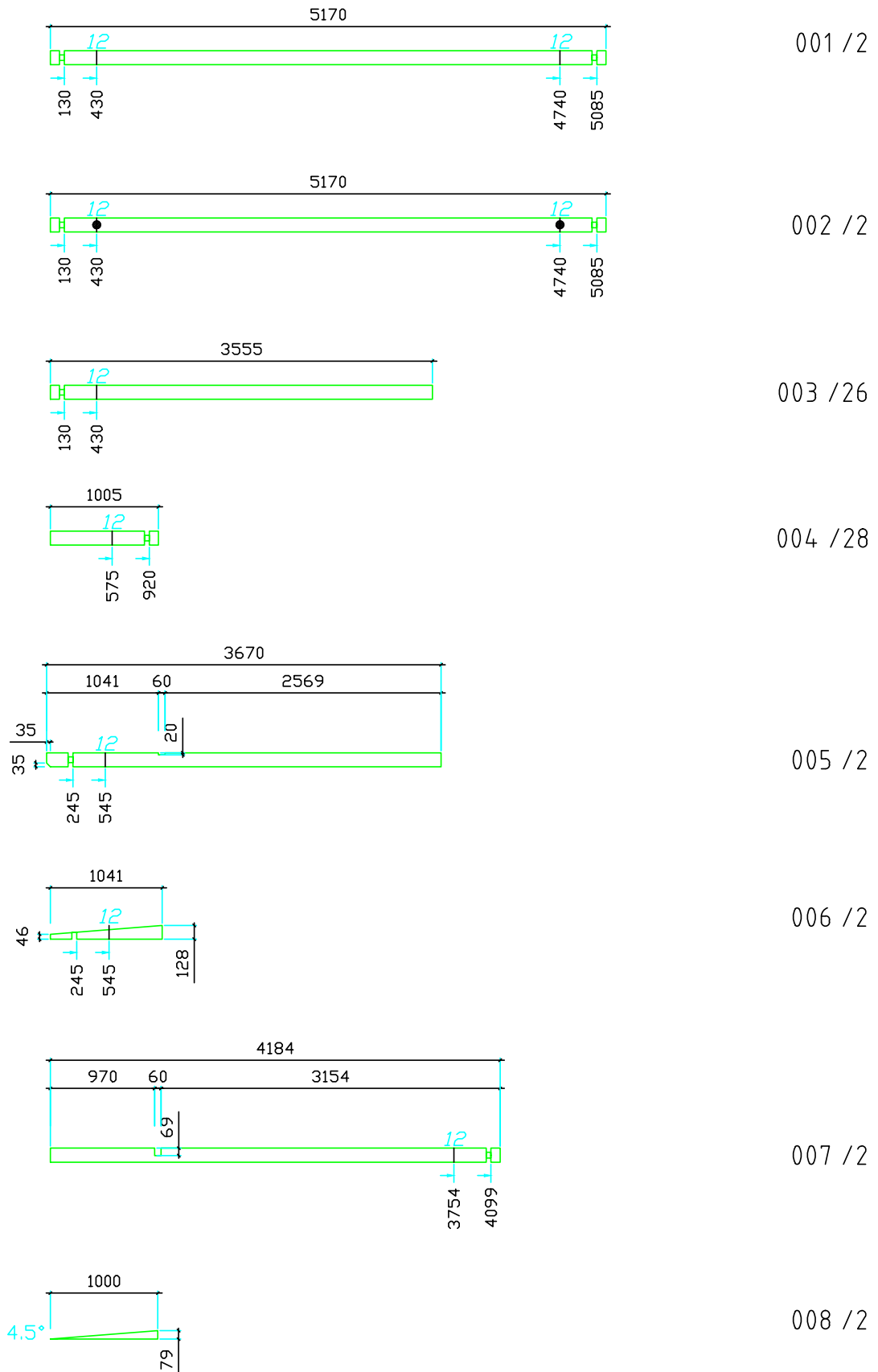

Teileliste 5

846440

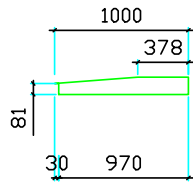

009 / 2

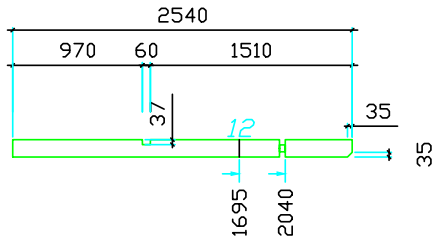

010 / 2

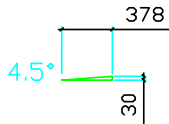

011 / 2

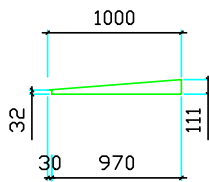

012 / 2

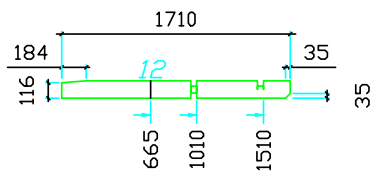

013 / 2

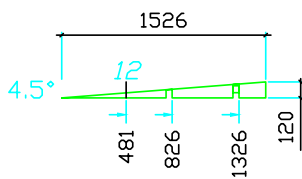

014 / 2

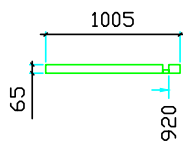

015 / 2

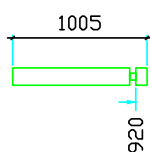

016 / 34

Teileliste 6

846440

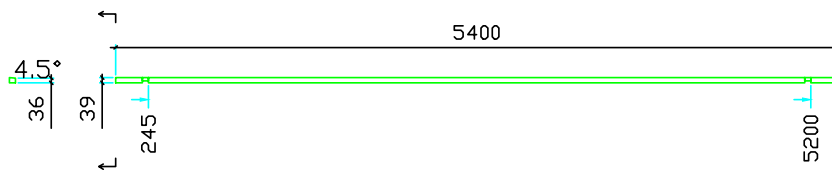
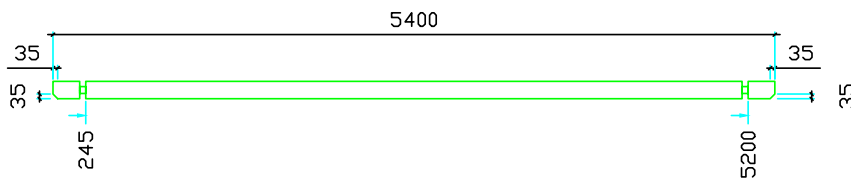
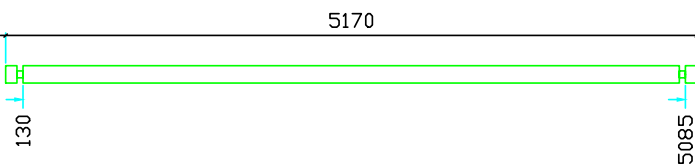
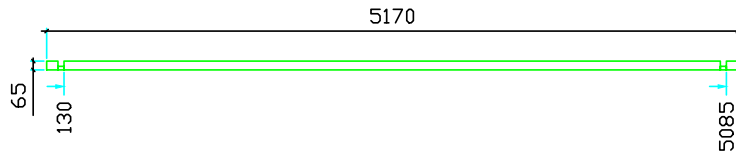
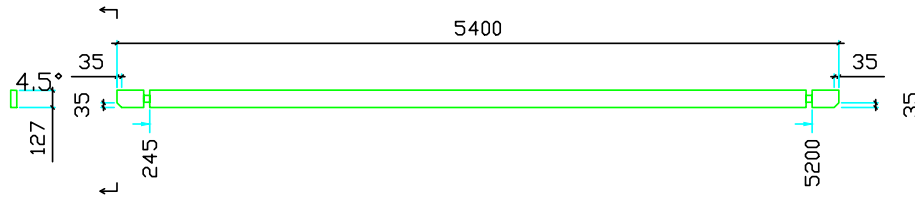
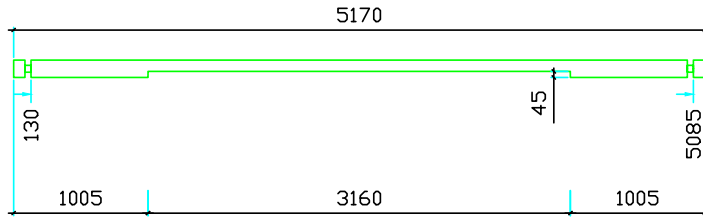

Teileliste 7

846440

Rahmen-Fundamentholz

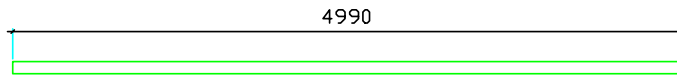

GR2 / 2
45x90

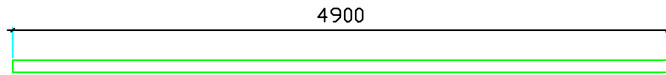

GR1 / 4
45x90

Fundamentholz

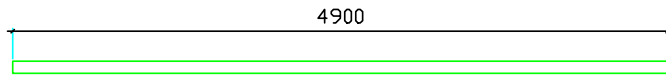

FB1 / 8
45x90

Pfetten

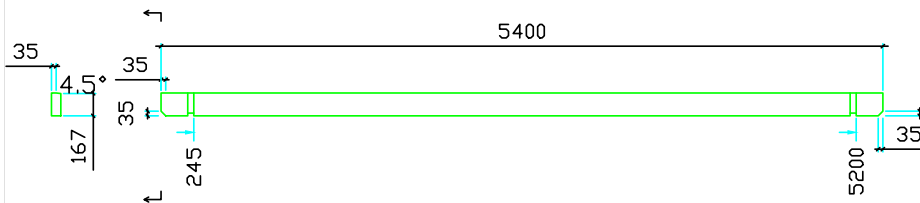

PR1 / 4
70x170(60x150)

Teileliste 8

846440

AL23

Hohes System

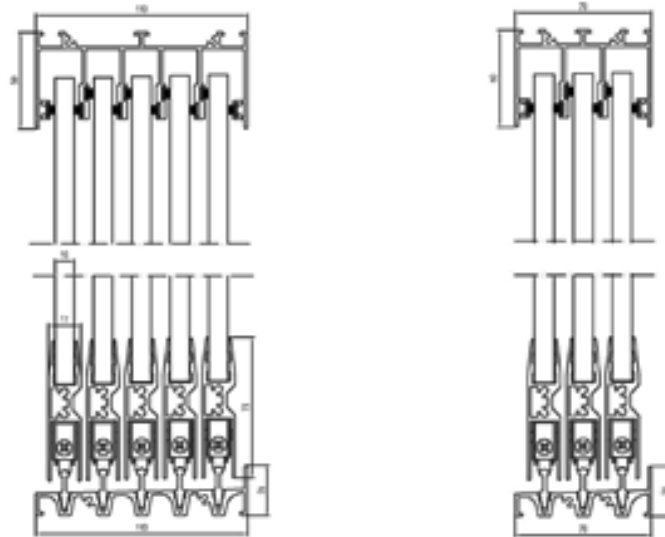

Übersicht Material tiefes System AL23



Teileliste 9

846440

Übersicht Material tiefes System AL23



Schloss Edelstahl
(optional)



Türgriff Edelstahl



Panelstopper

Wandplan 1 und 2 846440

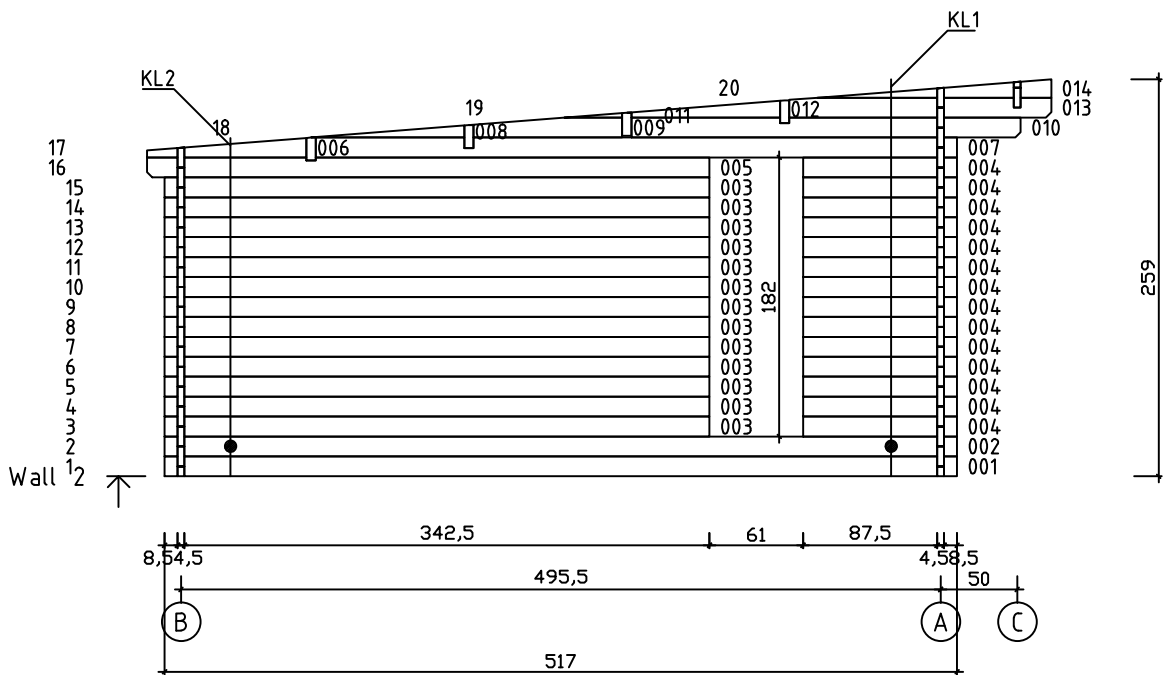
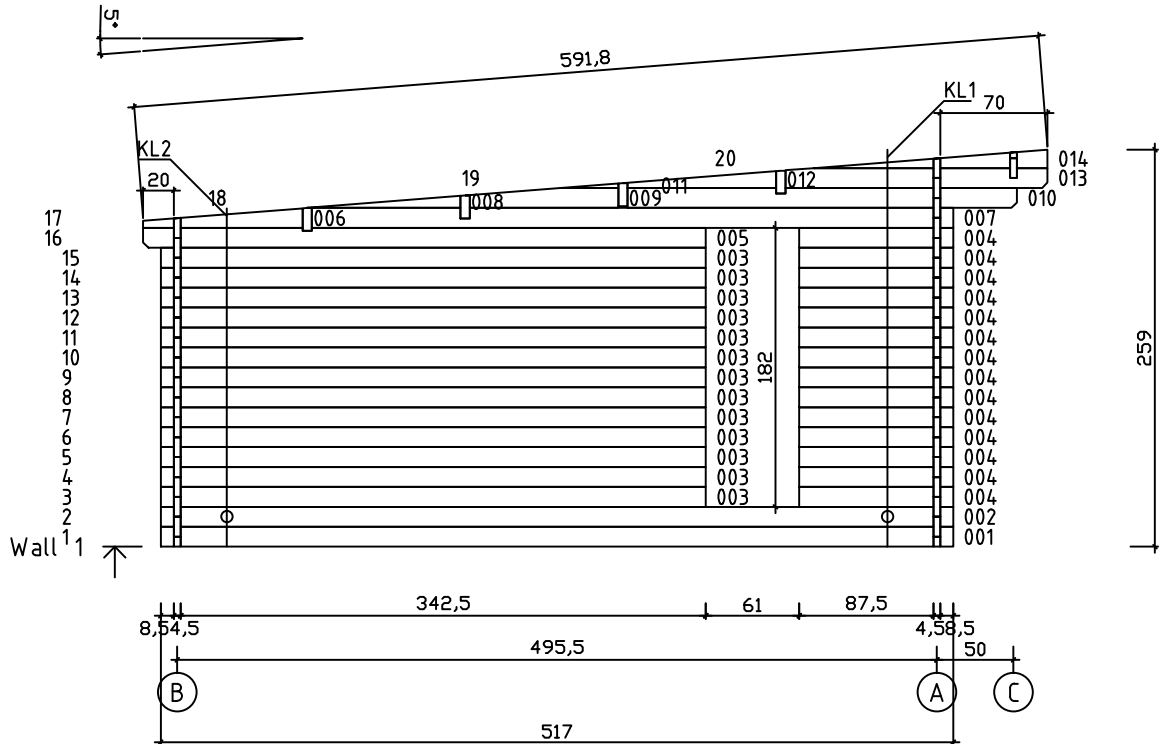

Wandplan A

846440

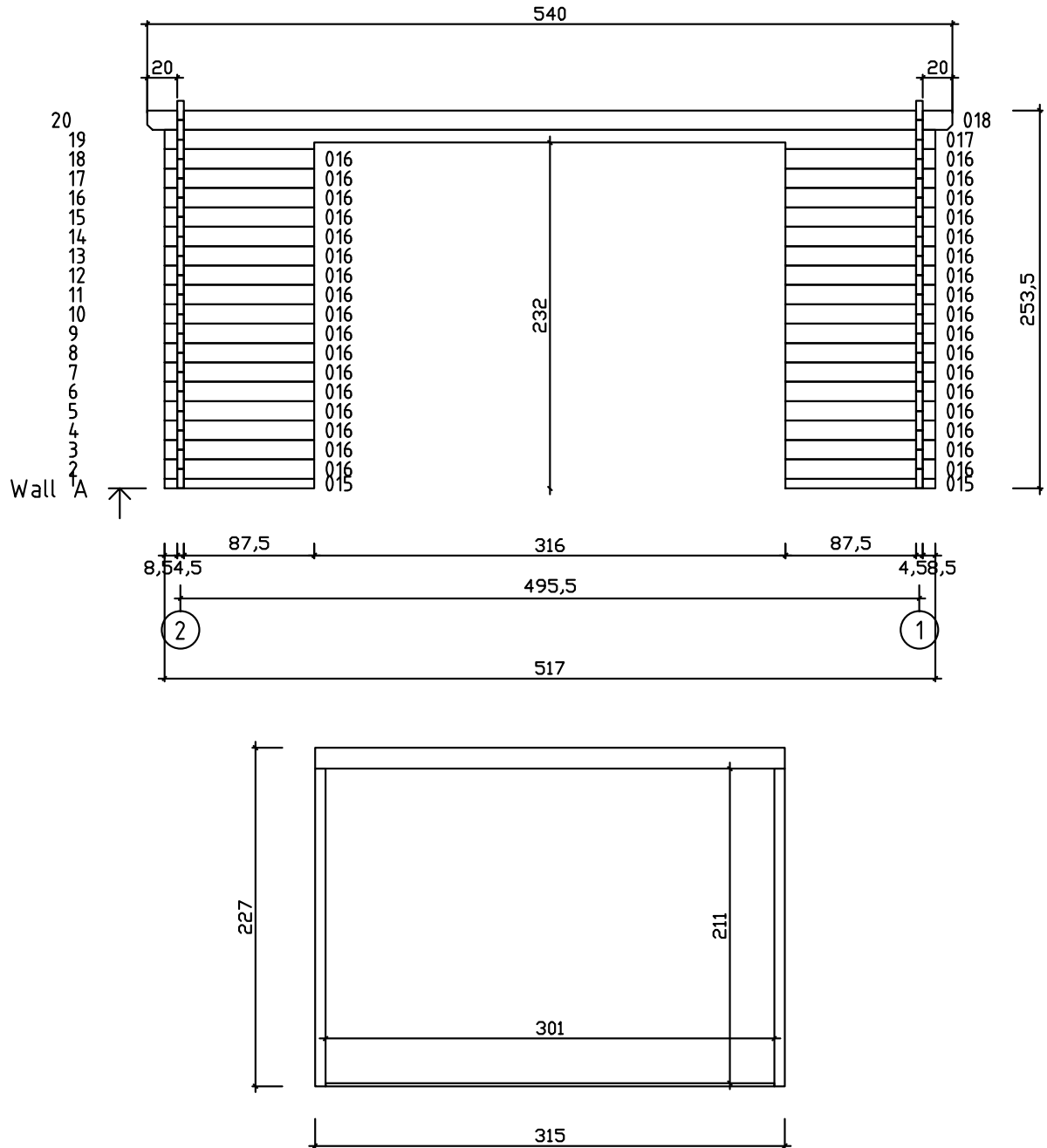

Wandplan B und C 846440

