

Technische Daten: Art.-Nr.: 870845

Wandaußenmaß: 500 x 500 cm

Bohlenstärke: 70 mm



Trondheim 70-D XL

Kontrolliert durch:

Empty box for signature or stamp.

Achtung: Alle angegebenen Maße sind ca.-Maße!

3D-Darstellung und Grundriss 870845

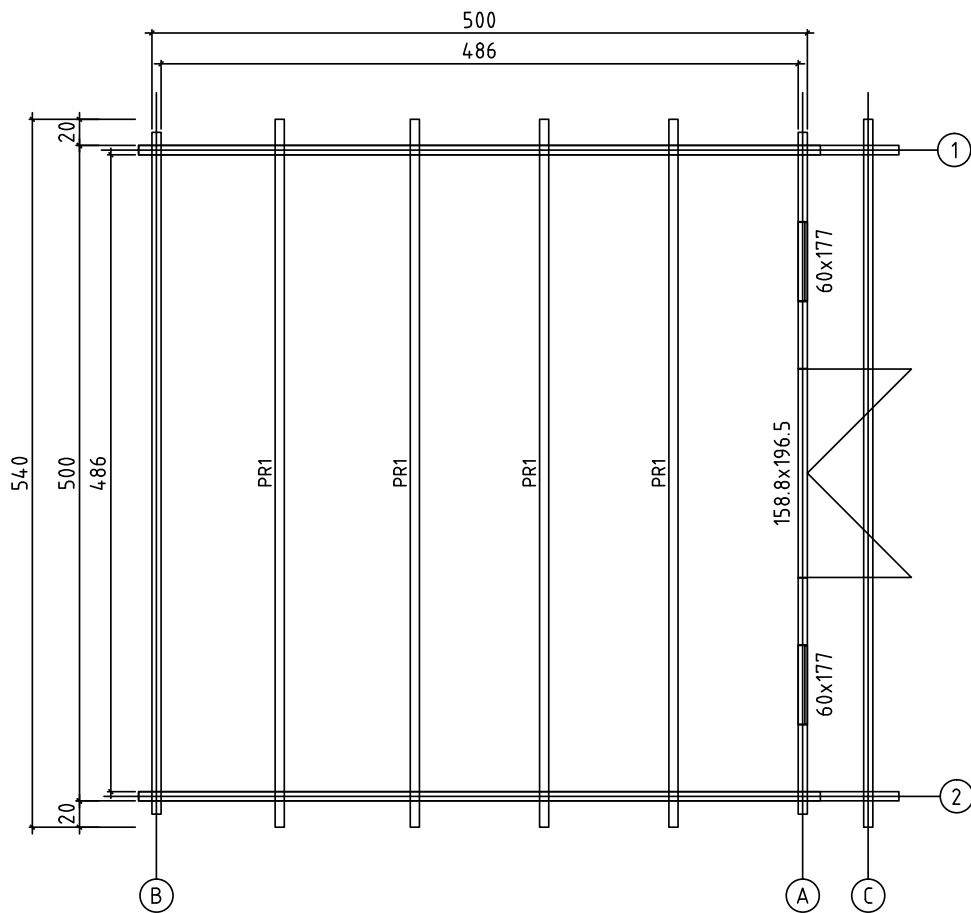
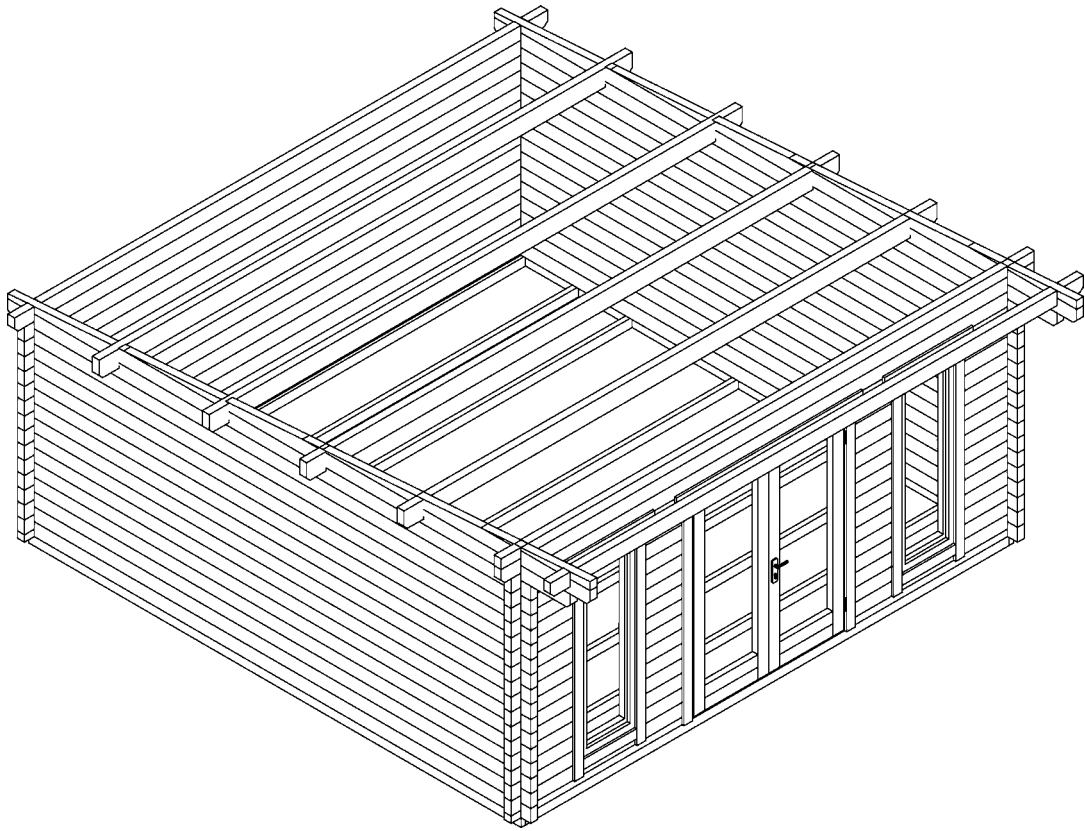



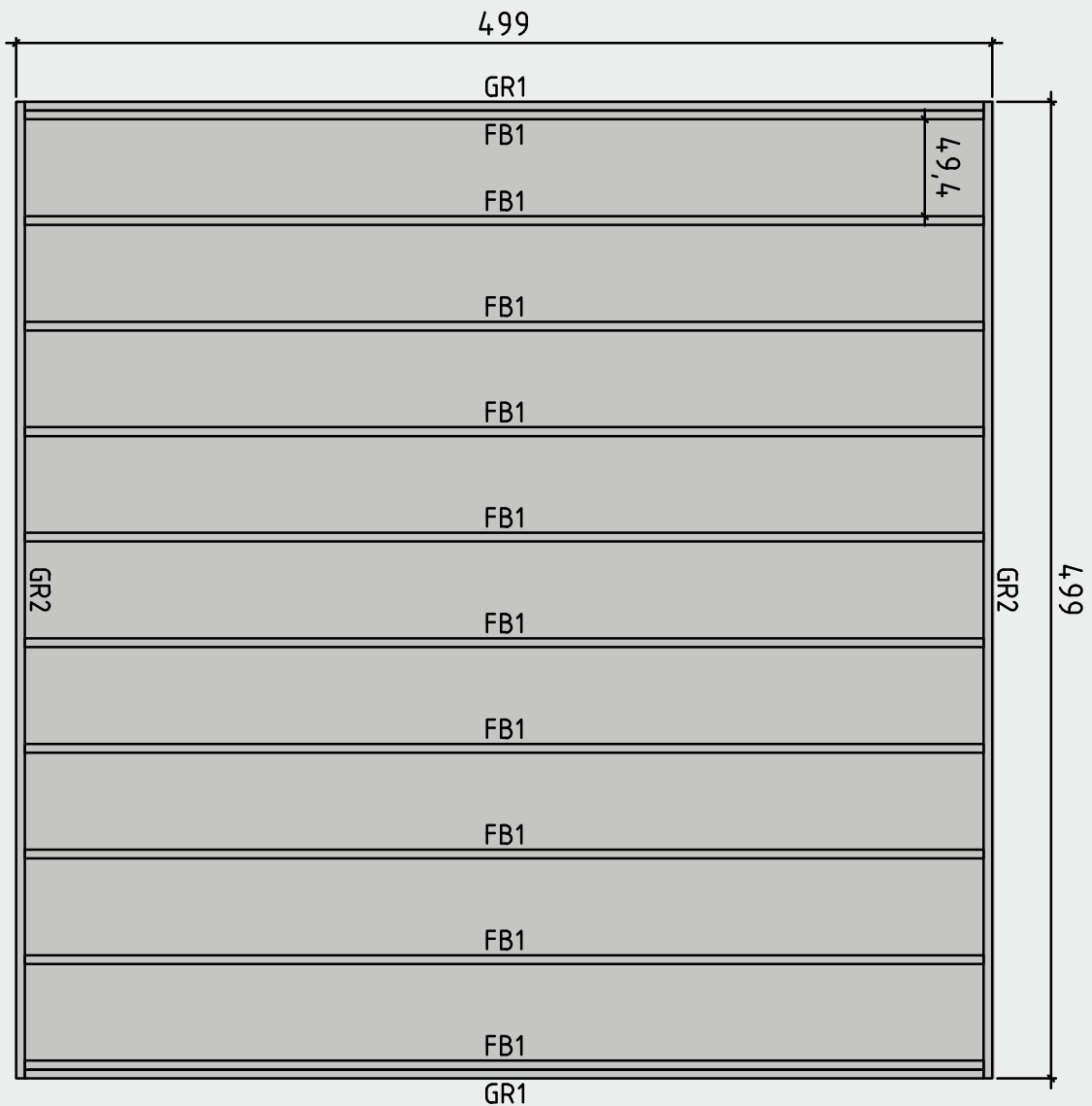

Lagerholzplan und Fundamentplan 870845

Wir empfehlen als Fundament für Ihr Gartenhaus eine vollflächig festgegründete, gepflasterte oder betonierte Fläche.
Wahlweise ist auch ein Punkt- oder Streifenfundament möglich.



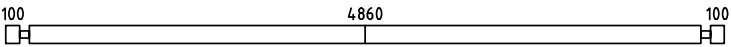
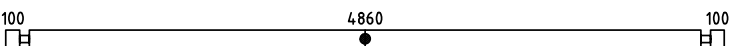
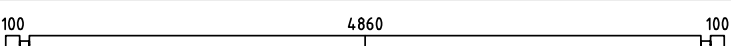
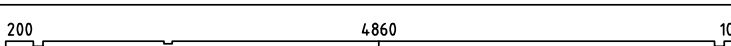
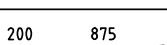
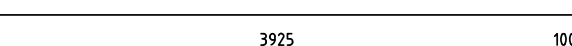
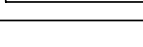

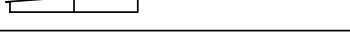
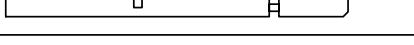
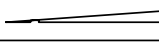
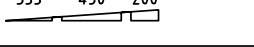
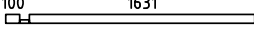
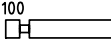

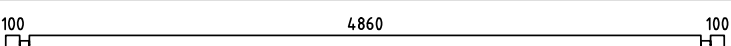
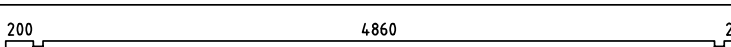
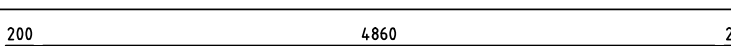
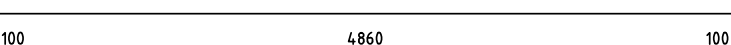
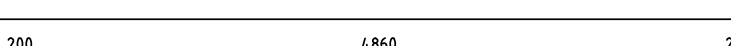
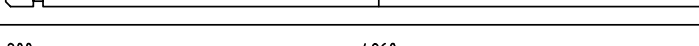
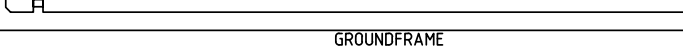
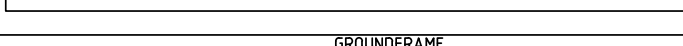
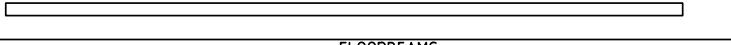





Teileliste 1

870845

| Pos | | | Profil (mm) | Lenght (mm) |
|-----|--|----|-------------|-------------|
| 001 |  | 2 | 70x130 | 5200 |
| 002 |  | 3 | 70x130 | 5200 |
| 003 |  | 37 | 70x130 | 5200 |
| 004 |  | 2 | 70x130 | 5300 |
| 005 |  | 2 | 70x128 | 1145 |
| 006 |  | 2 | 70x130 | 4095 |
| 007 |  | 2 | 70x72 | 1002 |
| 008 |  | 2 | 70x130 | 956 |
| 009 |  | 2 | 70x130 | 2477 |
| 010 |  | 2 | 70x130 | 2915 |
| 011 |  | 2 | 70x79 | 1105 |
| 012 |  | 2 | 70x65 | 1801 |
| 013 |  | 2 | 70x130 | 1801 |
| 014 |  | 28 | 70x130 | 681 |
| 015 |  | 28 | 70x130 | 510 |
| 016 |  | 1 | 70x130 | 5200 |
| 017 |  | 1 | 70x130 | 5400 |
| 018 |  | 1 | 70x94 | 5400 |
| 019 |  | 1 | 70x65 | 5200 |
| 020 |  | 1 | 70x130 | 5400 |
| 021 |  | 1 | 70x130 | 5400 |
| GR2 |  | 2 | 45x90 | 4990 |
| GR1 |  | 2 | 45x90 | 4900 |
| FB1 |  | 10 | 45x90 | 4900 |
| PR1 |  | 4 | 70x170 | 5400 |

Teileliste 2

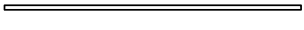
870845

| Pos | | | Profil (mm) | Lenght (mm) |
|-----|---|--|----------------|----------------|
| | WINDOW 600x1770 | | 2 | |
| | DOOR 1588x1965 | | 1 | |
| 1 | Screws/Schrauben/Vis 5x100 mm- For fixing first row of wall logs /Fixierung des ersten Bohlenkranzes/Pour fixer les lamesde plancher |  | 6 | |
| 2 | Nails/Nägél/Clous 2.5x50 - For fixing floorboards/ Befestigung Fussbodenbretter/Pour fixer les lames de plancher |  | 550 | |
| 3 | Nails/Nägél/Clous 2.5x50 - For fixing roofboards/ Befestigung Dachbretter/Pour fixer les voliges |  | 425 | |
| 4 | Nails/Nägél/Clous 2.5x50 - For fixing floor edge trims/ Befestigung Fussleisten/Pour fixer les plinthes du plancher |  | 40 | |
| 5 | Nails/Nägél/Clous 2.5x50 - For fixing roofing felt fillet/ Befestigung giebelabschlussbrett/Pour fixer la latte de finition de la couverture |  | 40 | |
| 6 | Screws/Schrauben/Vis 2,5x50 mm- For fixing roof side boards and roof edge reinforcement Befestigung Traufenbretter und Traufenleisten Pour fixer les planches de rive et le tasseau de refreont |  | 175 | |
| 7 | Screws/Schrauben/Vis 2,5x50 mm- For fixing fascia boards and diamonds/ Befestigung Giebelblende und Raute Pour fixer les planches de rive et le diamant |  | | |
| 8 | Screws/Schrauben/Vis 2,5x50 mm- For fixing fwindow and door trims/ Befestigung Fenster und türen/ Pour fixer les croisillons des fenetres et des portes |  | | |
| 9 | Metal storm Brace/Gewindestange/Tige filetee 10 mm |  | 3 | |
| 10 | Shim;Nuts/Mutter ,U-Scheibe/Ecrou;Rondelle 10 mm For fixing storm braces/ Pour fixer les anti tempete/ Für Sturmleisten Pour fixer les croisillons des fenetres et des portes Metal storm Brace/Gewindestange/Tige filetee 10 mm KL1 M10 2,11 m 1 Screws 180 6 pcs. KL2 M10 2,31 m 2 Plastic caps 3 pcs. |  | 3/3 | |

Teileliste 3

870845

| POS | ST. | B | H | L | Teileliste |
|------|--------------------|------|------|-----------------------|---|
| FB1 | Vt. spetsi | | | | FUNDMENTHOLZER |
| F1 | 23,6m ² | 28 | | 4855 | FUSSBODENBRETTER |
| PR | 4 | 70 | 170 | 5400 | DACHBALKEN |
| RB1 | 32m ² | 20 | | 5915 | DACHBRETTER |
| R1 | 2 | 20 | 140 | 5440 | <small>Vaata keltise kalenirika</small> Traufenbretter |
| R2 | 2 | 45 | 65 | 5400 | <small>Vaata keltise kalenirika</small> Traufenbretter |
| R3 | 4 | 20 | 140 | 3060 | <small>Vaata keltise kalenirika</small> Giebelabschlussleiste |
| R4 | 4 | 20 | 90 | 3060 | Giebelabschlussleiste |
| WN06 | 2 | 600 | 1770 | | <p style="margin: 0;">Sliding slats 30x30x1700 mm - 4 pcs.</p> |
| DR16 | 1 | 1588 | 1965 | | |
| P1 | 21m | 20 | 40 | | Fußbodenleiste |
| P2 | 6+6 | 20 | 90 | 1945 | Türleiste DR 16, Fensterleiste WN 06 |
| P3 | 2+2 | 20 | 90 | 900 | Fensterleiste WN 06 |
| P4 | 2+2 | 20 | 90 | 540 570 | Fensterleiste WN 06 |
| P5 | 1+1 | 20 | 90 | 1890 | Türleiste DR 16 |

Detailzeichnungen 870845

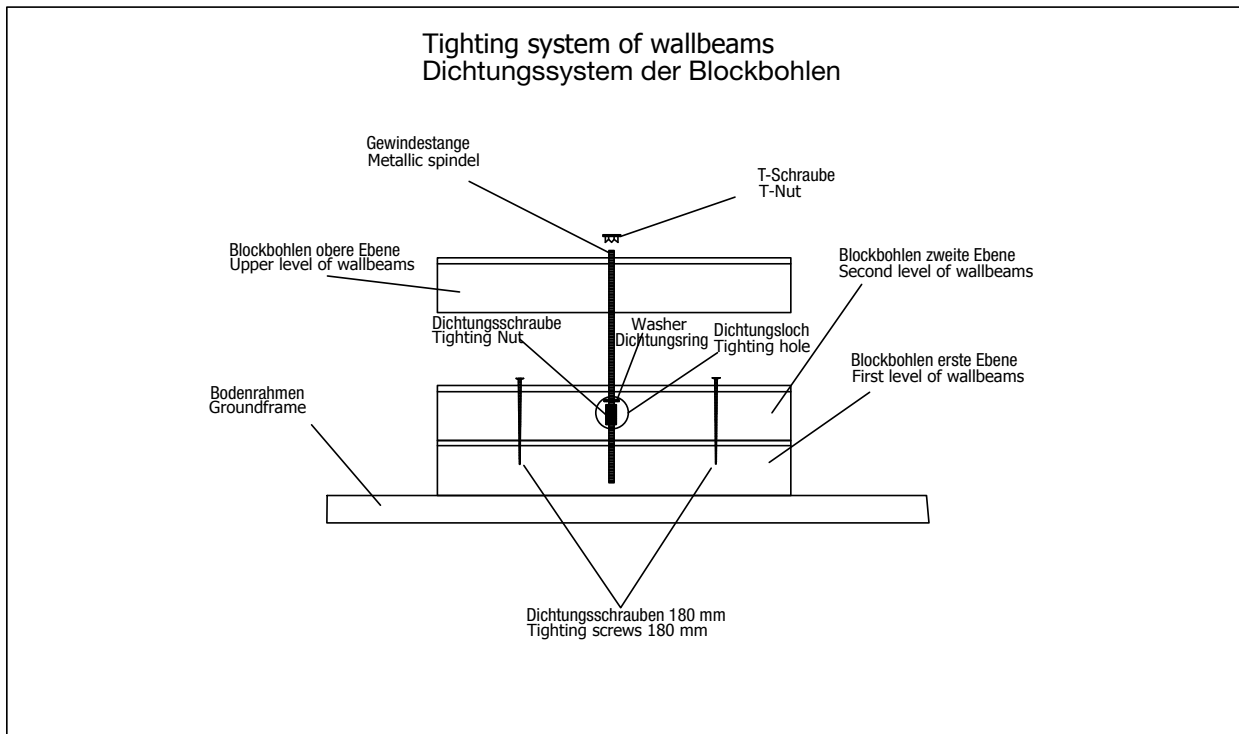
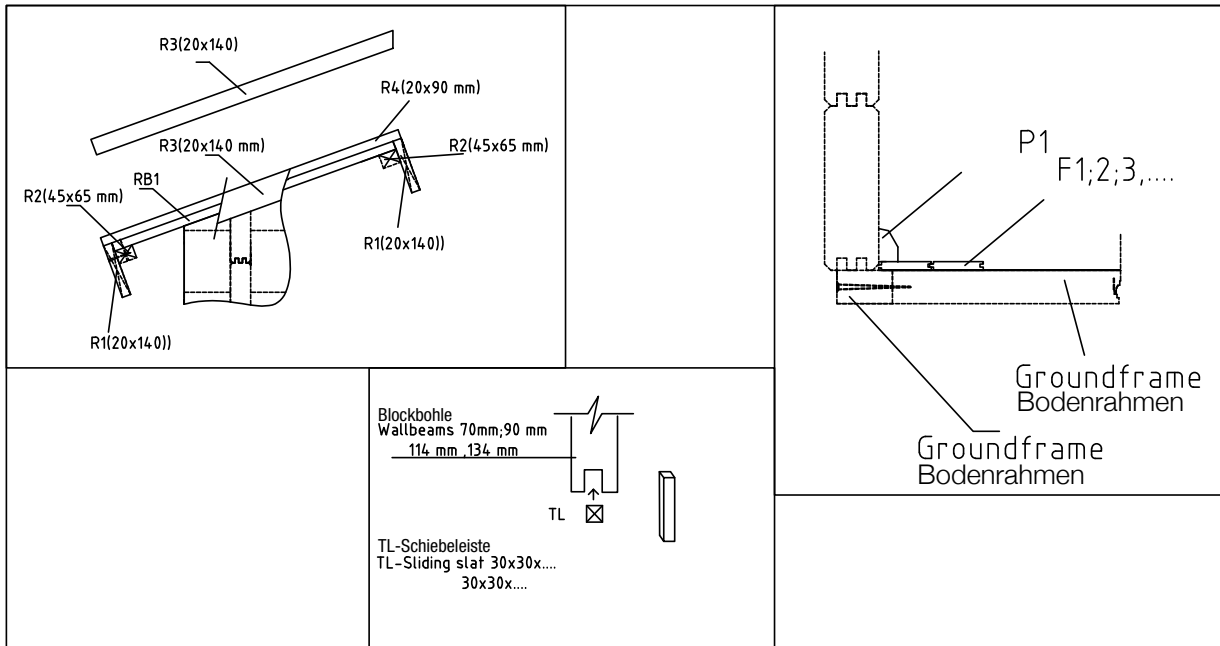

Wandplan 1 und 2 870845

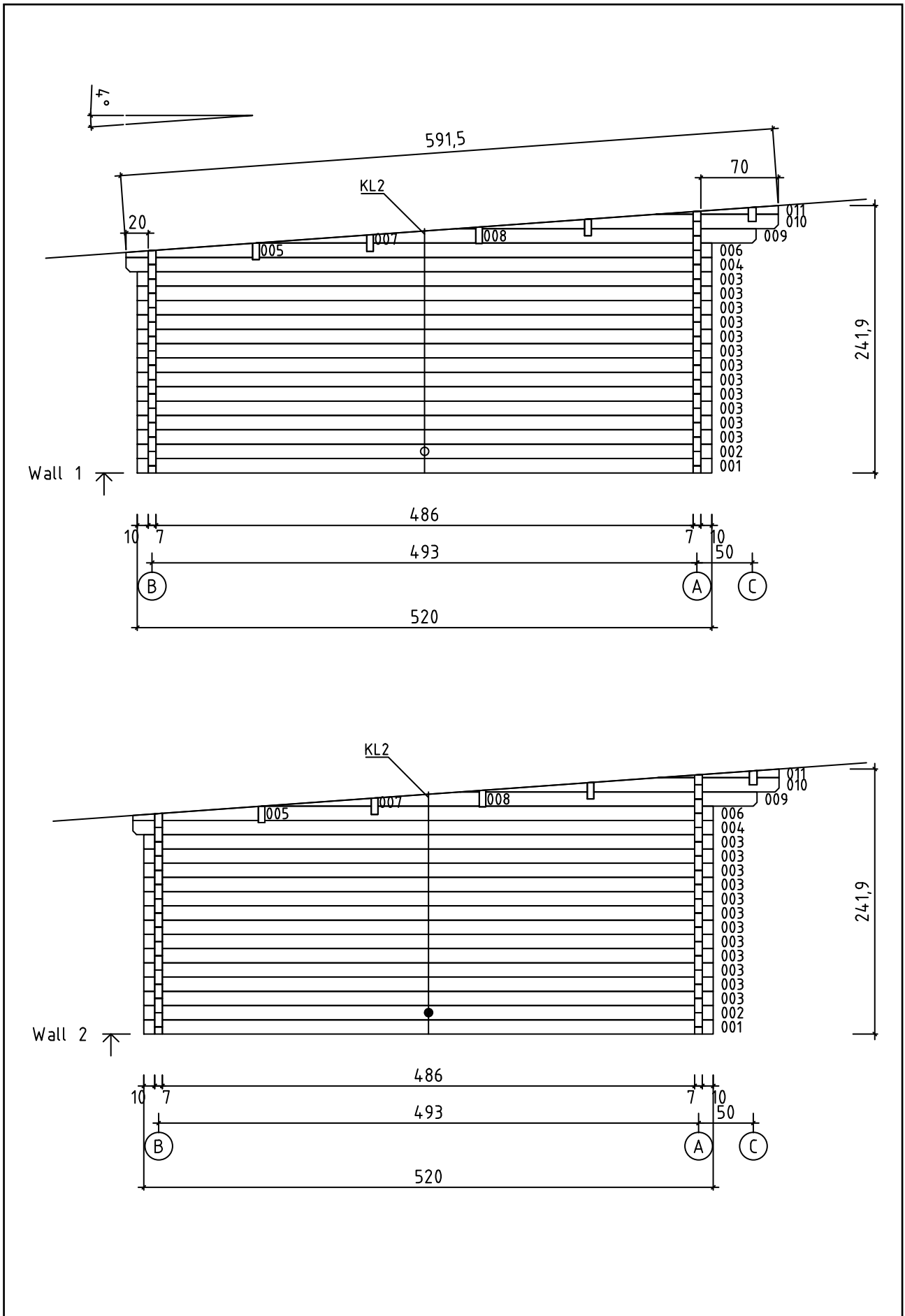

Wandplan A und B 870845

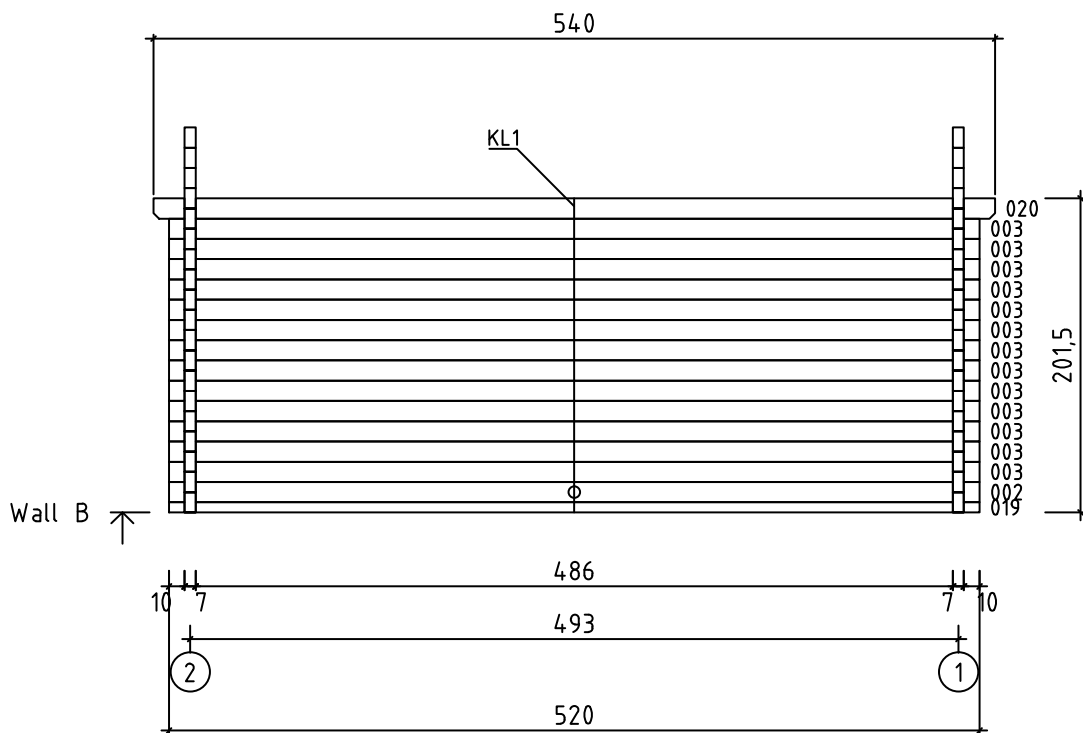
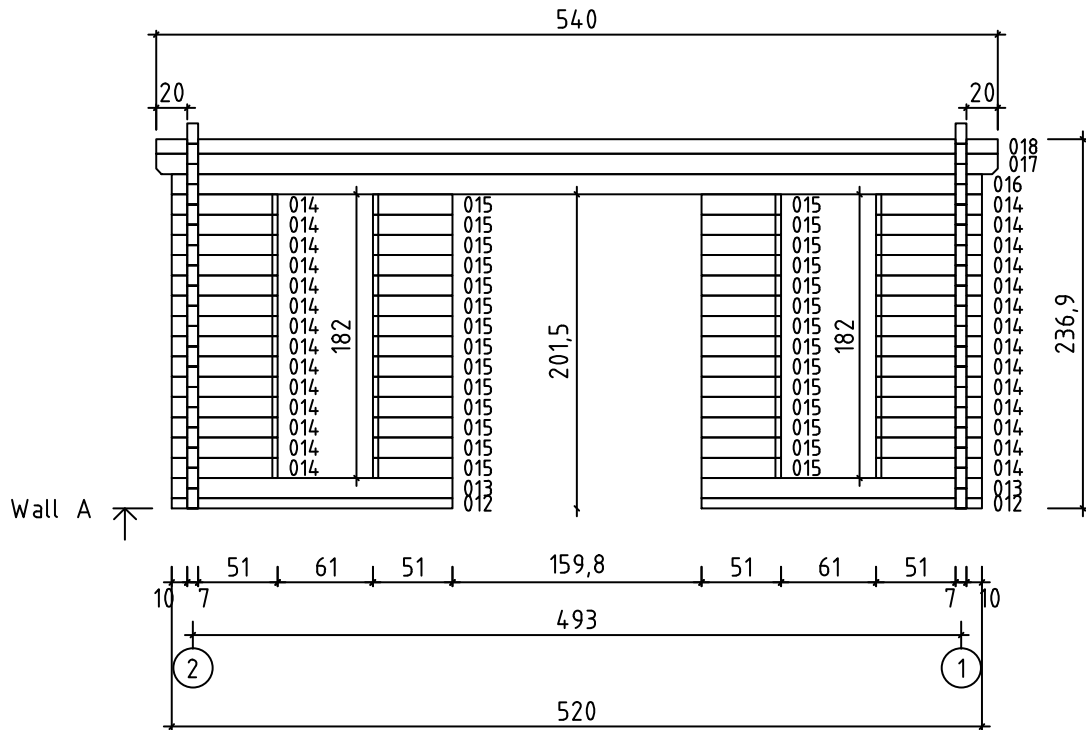

Wandplan C

870845

Vorgelagerte Vordachbohle vor Wand A

