

Technische Daten: Art.-Nr.: 870865

Wandaußenmaß: 530 x 530 cm

Bohlenstärke: 70 mm



Trondheim 70-D XL

Kontrolliert durch:

Empty box for signature or name.

Achtung: Alle angegebenen Maße sind ca.-Maße!

3D-Darstellung und Grundriss 870865

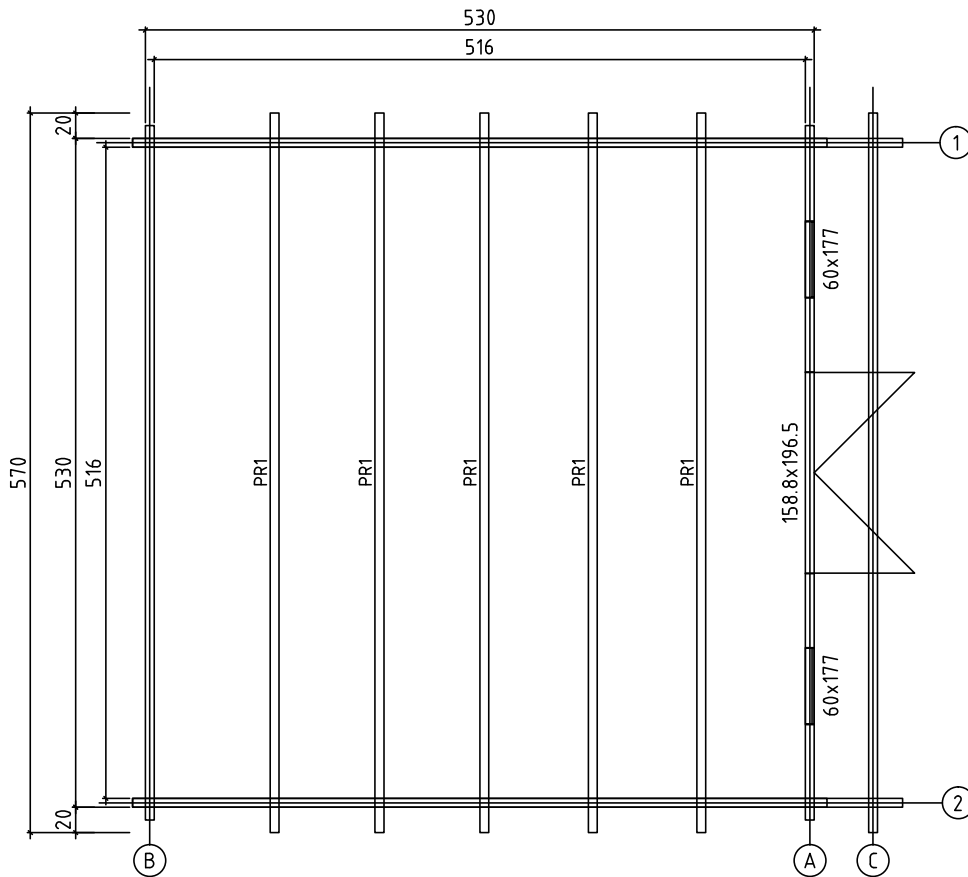
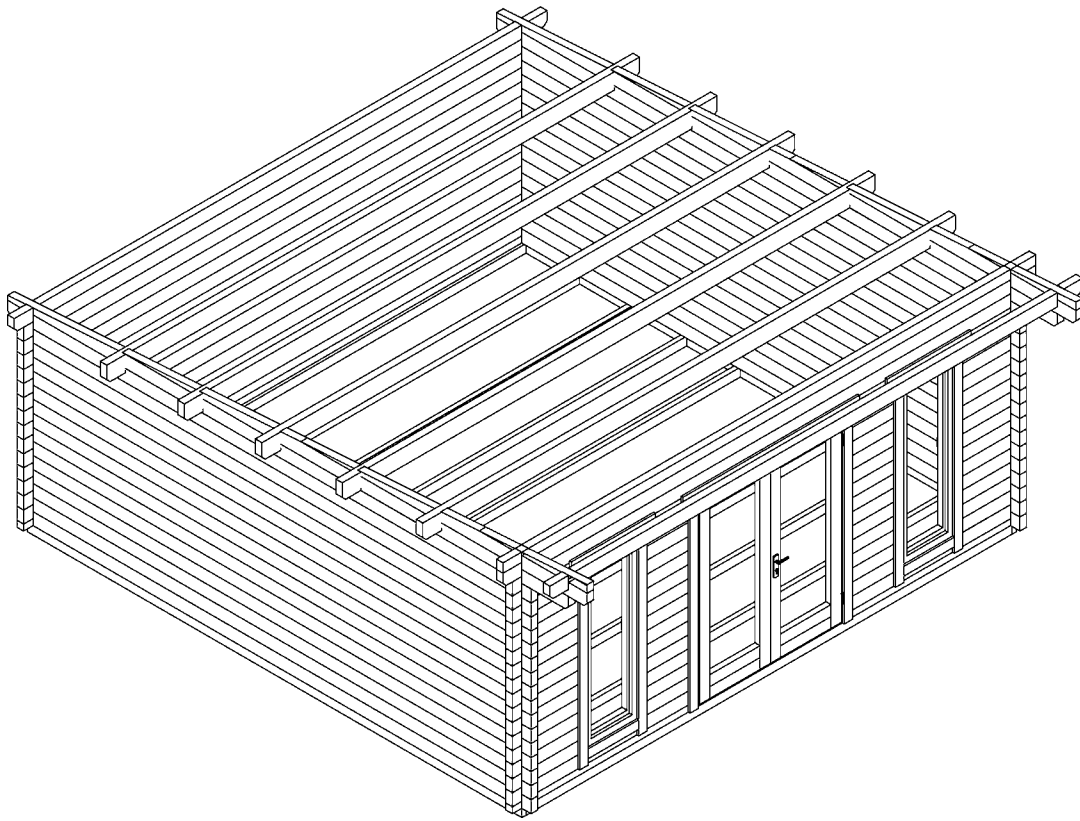





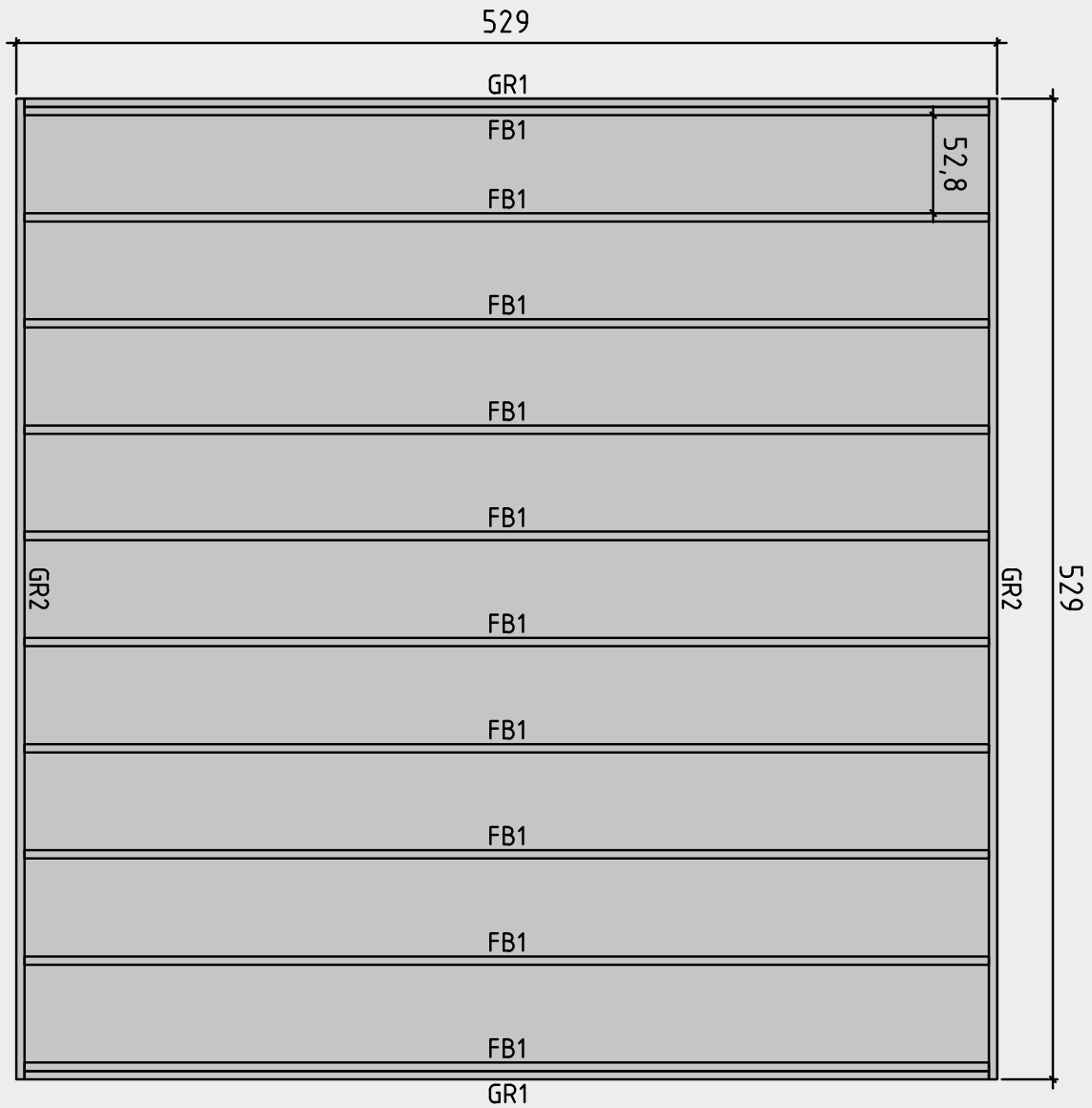

Lagerholzplan und Fundamentplan 870865

Wir empfehlen als Fundament für Ihr Gartenhaus eine vollflächig,
festgegründete gepflasterte oder betonierte Fläche.
Wahlweise ist auch ein Punkt- oder Streifenfundament möglich.

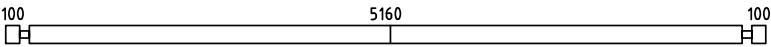
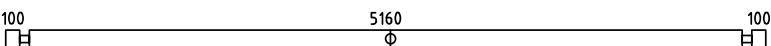
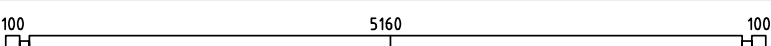
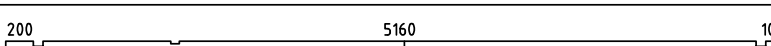
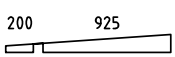
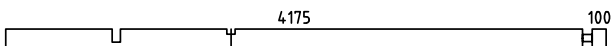

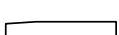
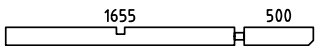

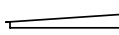
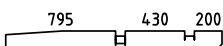
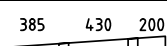
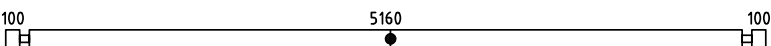
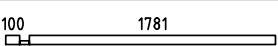
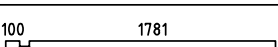
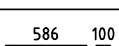

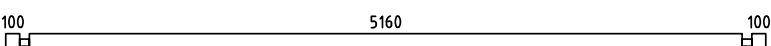
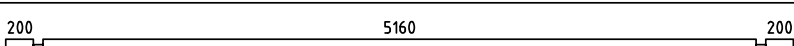
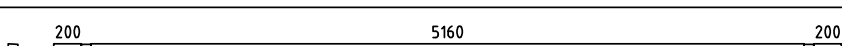
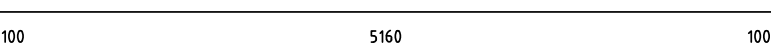
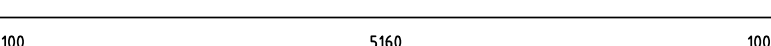
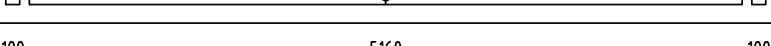





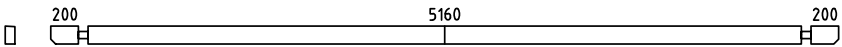
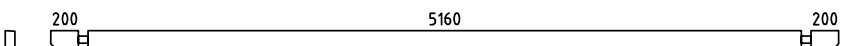
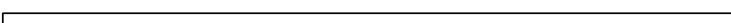

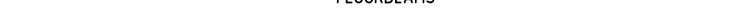
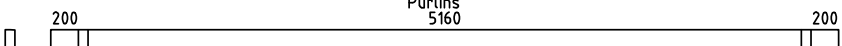
Teileliste 1

870865

Pos			Profil (mm)	Lenght (mm)
001		2	70x130	5500
002		1	70x130	5500
003		24	70x130	5500
004		2	70x130	5600
005		2	70x128	1195
006		2	70x130	4345
007		2	70x54	800
008		2	70x111	800
009		2	70x130	800
010		2	70x130	2225
011		2	70x39	580
012		2	70x98	831
013		2	70x130	1565
014		2	70x79	1155
015		1	70x130	5500
016		2	70x65	1951
017		2	70x130	1951
018		28	70x130	756
019		28	70x130	586
020		1	70x130	5500
021		1	70x130	5700
022		1	70x96	5700
023		1	70x65	5500
024		1	70x130	5500
025		13	70x130	5500

Teileliste 2

870865

Pos			Profil (mm)	Lenght (mm)
026		1	70x130	5700
027		1	70x130	5700
GR2	GROUNDFRAME 	2	45x90	5290
GR1	GROUNDFRAME 	2	45x90	5200
FB1	FLOORBEAMS 	10	45x90	5200
PR1	Purlins 5160 	5	70x170	5700
	WINDOW 600x1770	2		
	DOOR 1588x1965	1		
1	Screws/Schrauben/Vis 5x100 mm- For fixing first row of wall logs /Fixierung des ersten Bohlenkranzes/Pour fixer les lamesde plancher 	6		
2	Nails/Nägel/Clous 2.5x50 - For fixing floorboards/ Befestigung Fussbodenbretter/Pour fixer les lames de plancher 	575		
3	Nails/Nägel/Clous 2.5x50 - For fixing roofboards/ Befestigung Dachbretter/Pour fixer les voliges 	575		
4	Nails/Nägel/Clous 2.5x50 - For fixing floor edge trims/ Befestigung Fussleisten/Pour fixer les plinthes du plancher 	40		
5	Nails/Nägel/Clous 2.5x50 - For fixing roofing felt fillet/ Befestigung giebelabschlussbrett/Pour fixer la latte de finition de la couverture 	40		
6	Screws/Schrauben/Vis 2,5x50 mm- For fixing roof side boards and roof edge reinforcement Befestigung Traufenbretter und Traufenleisten Pour fixer les planches de rive et le tasseau de refront 	175		
7	Screws/Schrauben/Vis 2,5x50 mm- For fixing fascia boards and diamonds/ Befestigung Giebelblende und Raute Pour fixer les planches de rive et le diamant 			
8	Screws/Schrauben/Vis 2,5x50 mm- For fixing fwindow and door trims/ Befestigung Fenster und türen/ Pour fixer les croisillons des fenetres et des portes 			
9	Metal storm Brace/Gewindestange/Tige filetee 10 mm 	3		
10	Shim,Nuts/Mutter ,U-Scheibe/Ecrou;Rondelle 10 mm For fixing storm braces/ Pour fixer les anti tempete/ Für Sturmleisten Pour fixer les croisillons des fenetres et des portes  Metal storm Brace/Gewindestange/Tige filetee 10 mm KL1 M10 2,12 m 1 Screws 180 6 pcs. KL2 M10 2,18 m 2 Plastic caps 3 pcs.	3/3		

Teileliste 3

870865

POS	ST.	B	H	L	Teileliste
FB1	Vt. spetsi				FUNDMENTHOLZER
F1	26,6m ²	28		5155	FUSSBODENBRETTER
PR	5	70	170	5700	DACHBALKEN
RB1	16,5m ² 19m ²	20		2892 3323	DACHBRETTER
R1	2	20	140	5740	<small>Verstecktes Kettensystem</small> Traufenbretter
R2	2	45	65	5700	<small>Verstecktes Kettensystem</small> Traufenbretter
R3	4	20	140	3220	<small>Verstecktes Kettensystem</small> Giebelabschlussleiste
R4	4	20	90	3220	Giebelabschlussleiste
WN06	2	600	1770		 P3 P2 P2 P4 P5 P2 P2
DR16	1	1588	1965		 Sliding stats 30x30x1700 mm - 4 pcs.
P1	22m	20	40		Fußbodenleiste
P2	6+6	20	90	1945	Türleiste DR 16, Fensterleiste WN 06
P3	2+2	20	90	900	Fensterleiste WN 06
P4	2+2	20	90	540 570	Fensterleiste WN 06
P5	1+1	20	90	1890	Türleiste DR 16

Detailzeichnungen 870865

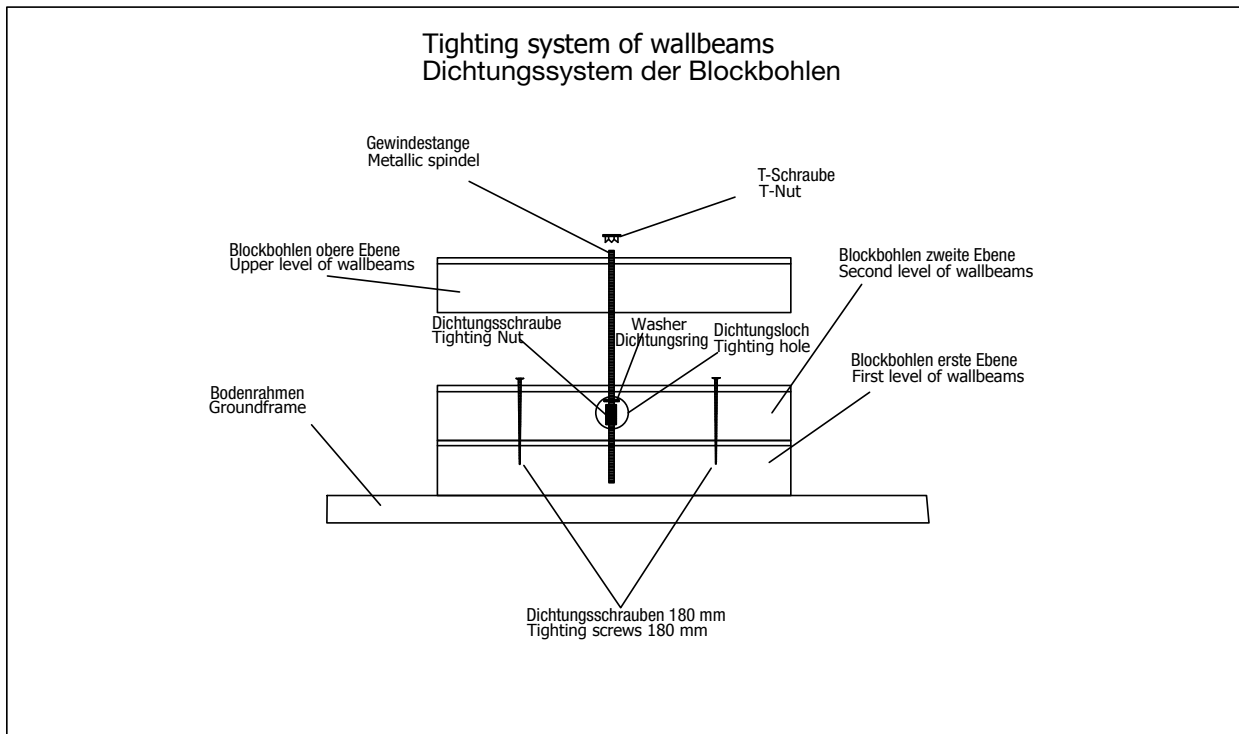
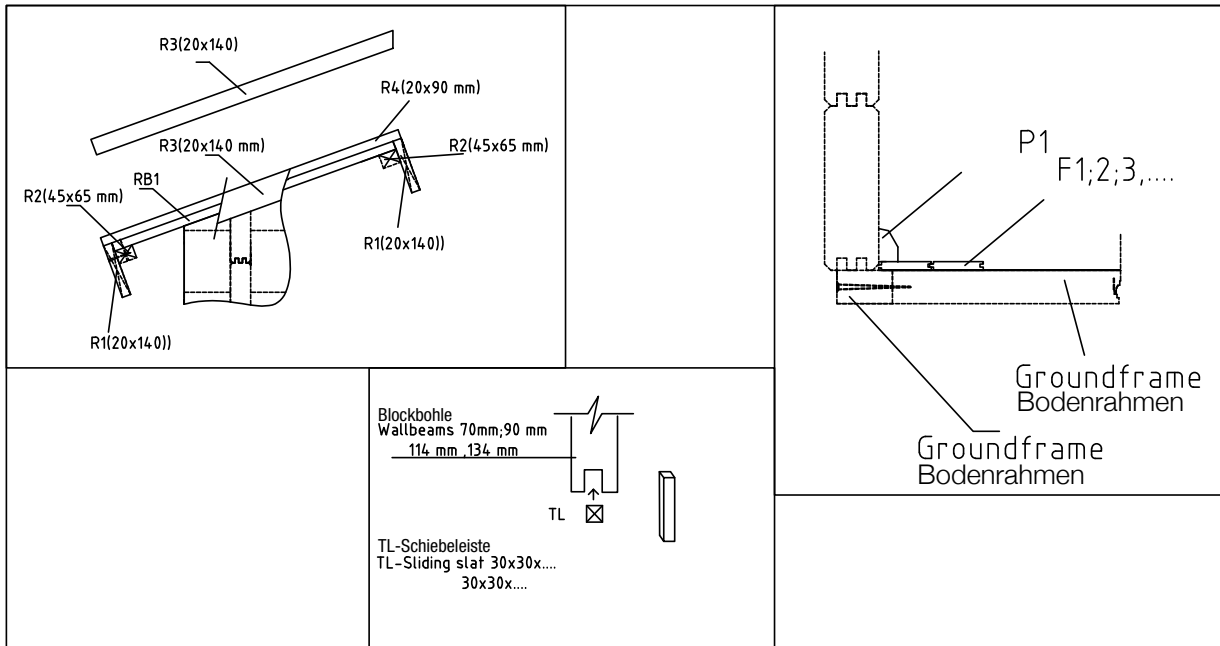

Wandplan 1 und 2 870865

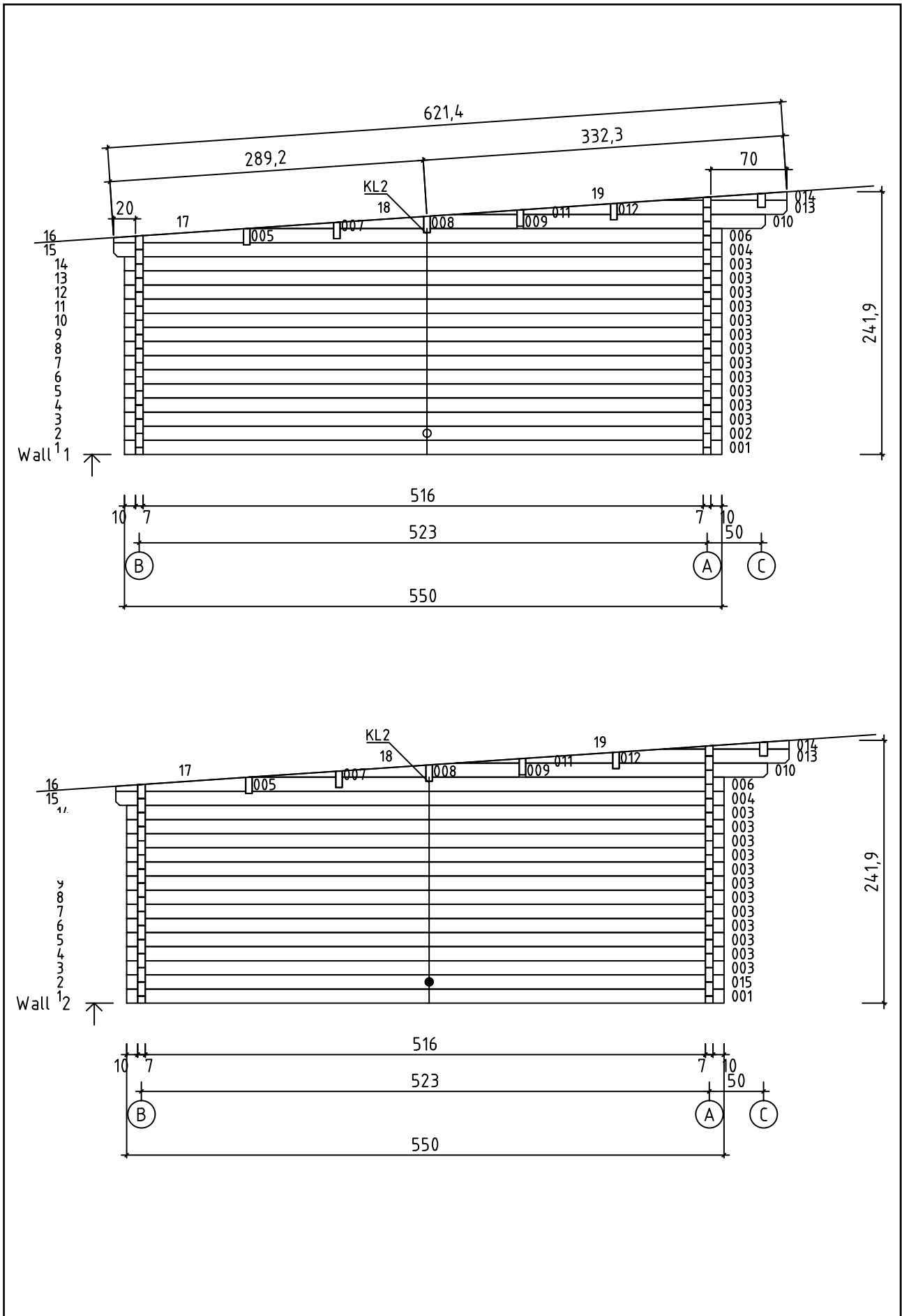

Wandplan A und B 870865

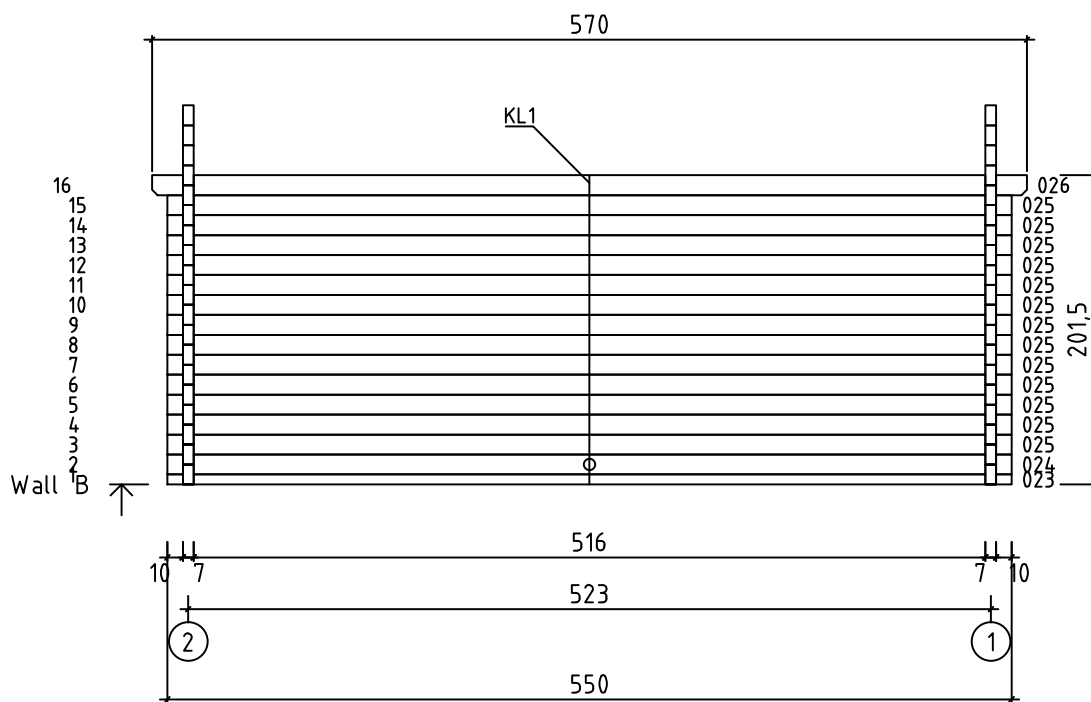
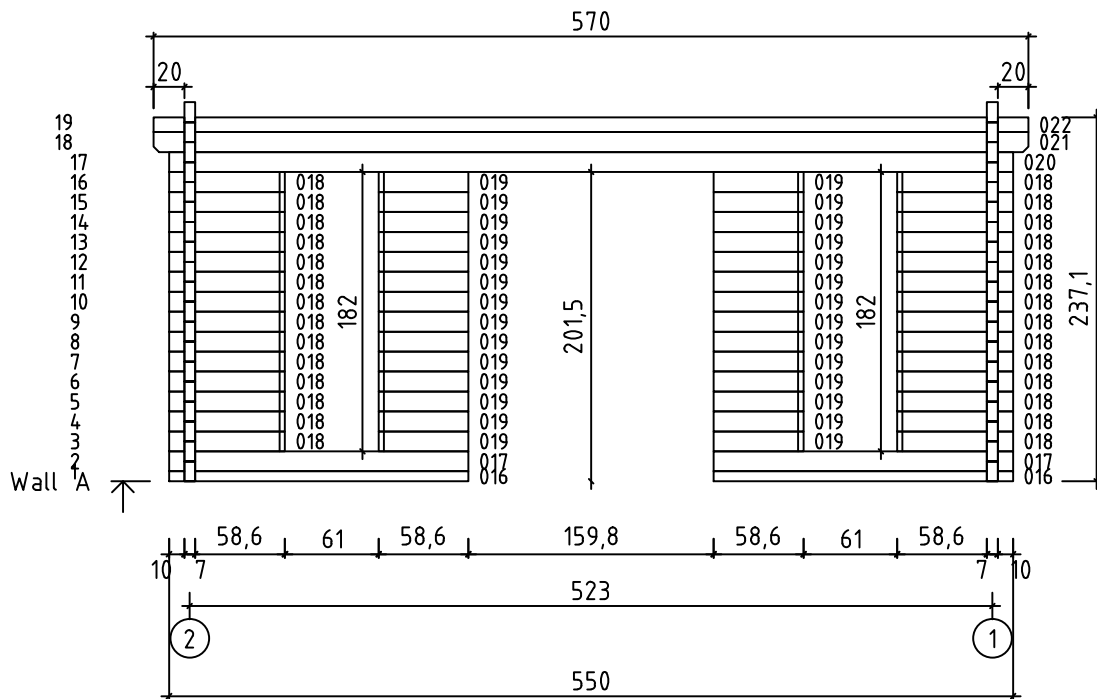

Wandplan C 870865

Vorgelagerte Vordachbohle vor Wand A

