

Technische Daten: Art.-Nr.: 870870

Wandaußenmaß: 450 x 360 cm

Bohlenstärke: 70 mm



Kontrolliert durch:

Empty rectangular box for signature or name.

Achtung: Alle angegebenen Maße sind ca.-Maße!

3D-Darstellung und Grundriss 870870

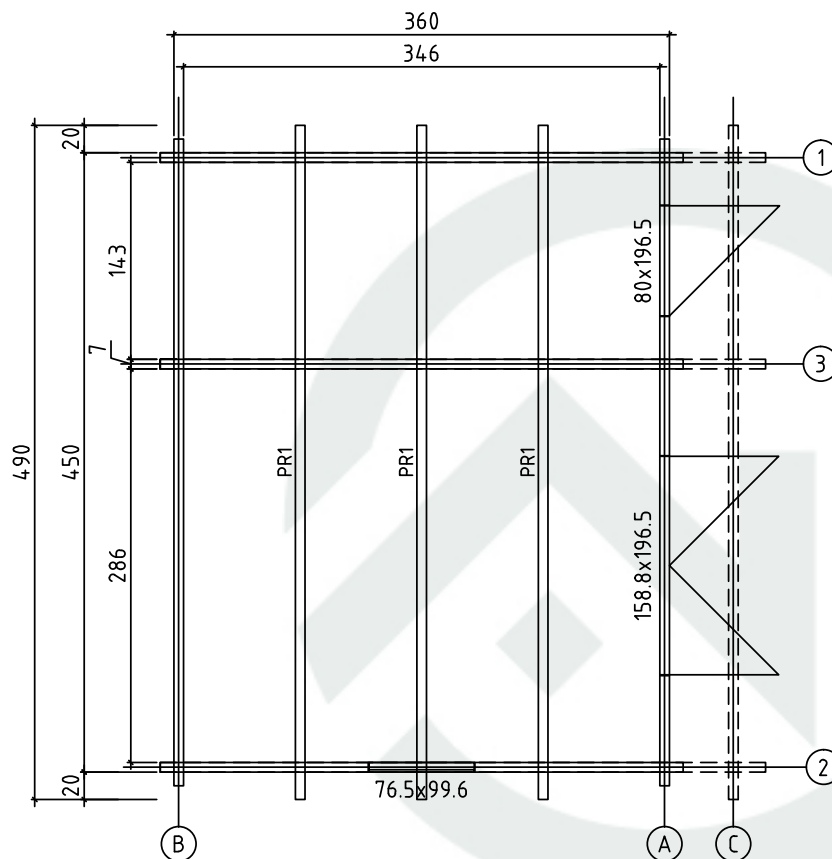
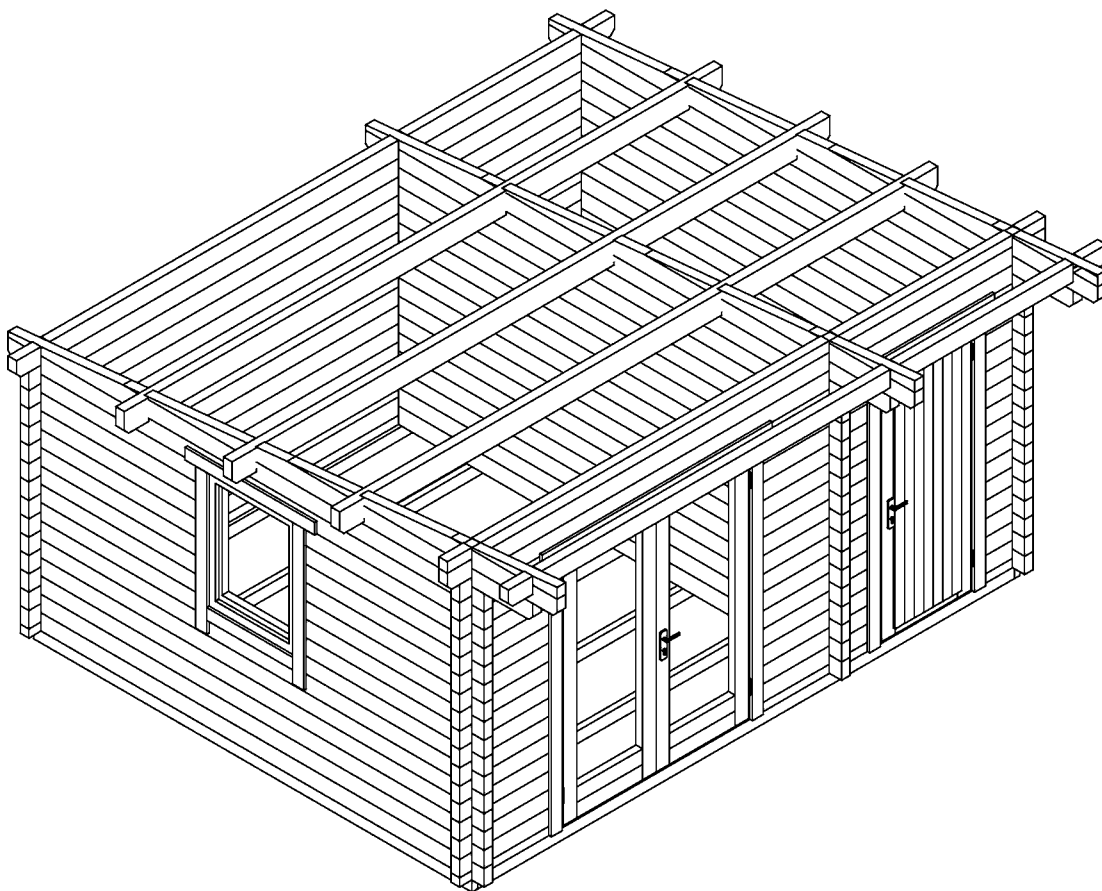

Lagerholzplan und Fundamentplan 870870

Wir empfehlen als Fundament für Ihr Gartenhaus eine vollflächig,
festgegründete gepflasterte oder betonierte Fläche.
Wahlweise ist auch ein Punkt- oder Streifenfundament möglich.

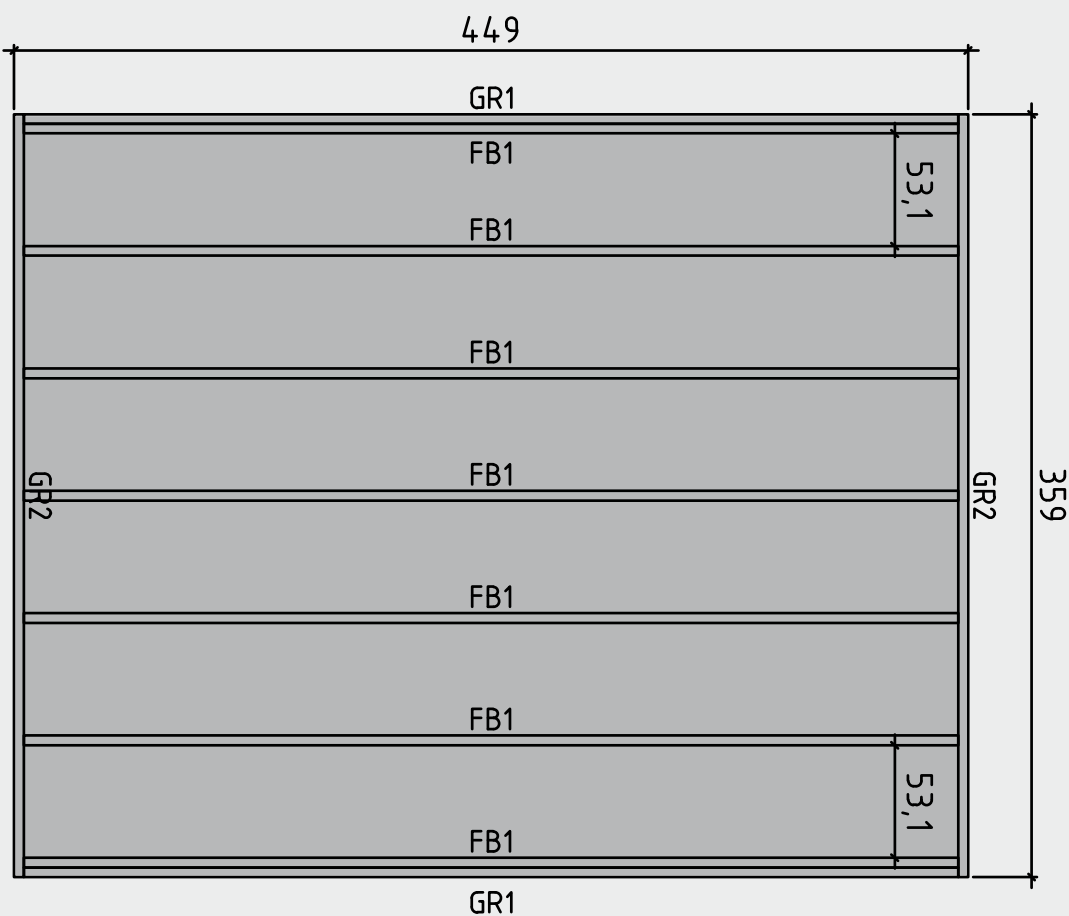

Teileliste 1

870870

Pos	Quantity	Profil (mm)	Length (mm)
001	2	70x130	3800
002	2	70x130	3800
003	16	70x130	3800
004	1	70x130	3900
005	2	70x130	1088
006	2	70x130	2753
007	3	70x14	146
008	3	70x100	853
009	2	70x130	2270
010	3	70x55	568
011	2	70x130	1618
012	3	70x84	872
013	1	70x130	3800
014	14	70x130	1513
015	1	70x130	3900
016	1	70x130	3800
017	13	70x130	3800
018	1	70x130	3900
019	1	70x130	1088
020	1	70x130	2753
021	1	70x130	2270
022	1	70x130	1618
023	1	70x65	801
024	1	70x65	1011
025	1	70x65	480

Teileliste 2

870870

Pos		Quantity	Profil (mm)	Lenght (mm)
026		15	70x130	801
027		15	70x130	1011
028		15	70x130	480
029		15	70x130	4700
030		1	70x130	4900
031		1	70x82	4900
032		1	70x65	4700
033		2	70x130	4900
GR1	Rahmen-Fundamentholz 	2	45x90	4400
GR2	Rahmen-Fundamentholz 	2	45x90	3590
FB1	Fundamentholz 	7	45x90	4400
PR1	 Pfetten	3	70x170	4900
	Fenster 765x996	1		
	Tür 800x1965	1		
	Tür 1588x1965	1		
1	Screws/Schrauben/Vis 5x100 mm- For fixing first row of wall logs /Fixierung des ersten Bohlenkranzes/Pour fixer les lamesde plancher 	6		
2	Nails/Nägel/Clous 2.5x50 - For fixing floorboards/ Befestigung Fussbodenbretter/Pour fixer les lames de plancher 	350		
3	Nails/Nägel/Clous 2.5x50 - For fixing roofboards/ Befestigung Dachbretter/Pour fixer les voliges 	350		
4	Nails/Nägel/Clous 2.5x50 - For fixing floor edge trims/ Befestigung Fussleisten/Pour fixer les plinthes du plancher 	50		
5	Nails/Nägel/Clous 2.5x50 - For fixing roofing felt fillet/ Befestigung giebelabschlussbrett/Pour fixer la latte de finition de la couverture 	30		
6	Screws/Schrauben/Vis 2,5x50 mm- For fixing roof side boards and roof edge reinforcement Befestigung Traufenbretter und Traufenleisten Pour fixer les planches de rive et le tasseau de refront 	150		
7	Screws/Schrauben/Vis 2,5x50 mm- For fixing fascia boards and diamonds/ Befestigung Giebelblende und Raute Pour fixer les planches de rive et le diamant 			
8	Screws/Schrauben/Vis 2,5x50 mm- For fixing fwindow and door trims/ Befestigung Fenster und türen/ Pour fixer les croisillons des fenetres et des portes 			
9	Metal storm Brace/Gewindestange/Tige filetee 10 mm 	4		
10	Shim/Nuts/Mutter ,U-Scheibe/Ecrou/Rondelle 10 mm For fixing storm braces/ Pour fixer les anti tempefe/ Für Sturmleisten Pour fixer les croisillons des fenetres et des portes  Metal storm Brace/Gewindestange/Tige filetee 10 mm KL1 M10 2,44 m 2 Screws 180 8 pcs. KL2 M10 2,18 m 2 Plastic caps 4 pcs.	4/4		

Teileliste 3

870870

POS	ST.	B	H	L			
FB1	Vt. spetsi					FUNDMENTHOLZER	
F1	15,1m ²	28		3455		FUSSBODENBRETTER	
PR	3	70	170	4900		DACHBALKEN	
RB1	22,2m ²	20		4521		DACHBRETTER	
R1	2	20	140	4940		Traufenbretter	
R2	2	45	65	4900		Traufenbretter	
R3	2	20	140	4720		Giebelabschlussleiste	
R4	2	20	90	4720		Giebelabschlussleiste	
DR1 DR2	1 1	1588 800	1965 1965				
WN1	1	765	996				
					Schiebelamellen 30x30x1900 mm - 4 Stk.		
P1	24m	20	40			Fussbodenleiste	
P2	1+1	20	90	1890		Türleiste DR1	
P3	4+4	20	90	1945		Türleiste DR1,DR2	
P4	1+1	20	90	1100		Türleiste DR2	
P5	1+1	20	90	1065		Fensterleiste WN1	
P6	2+2	20	90	1150		Fensterleiste WN1	
P7	1+1	20	90	705 735		Fensterleiste WN1	

Detailzeichnungen 870870

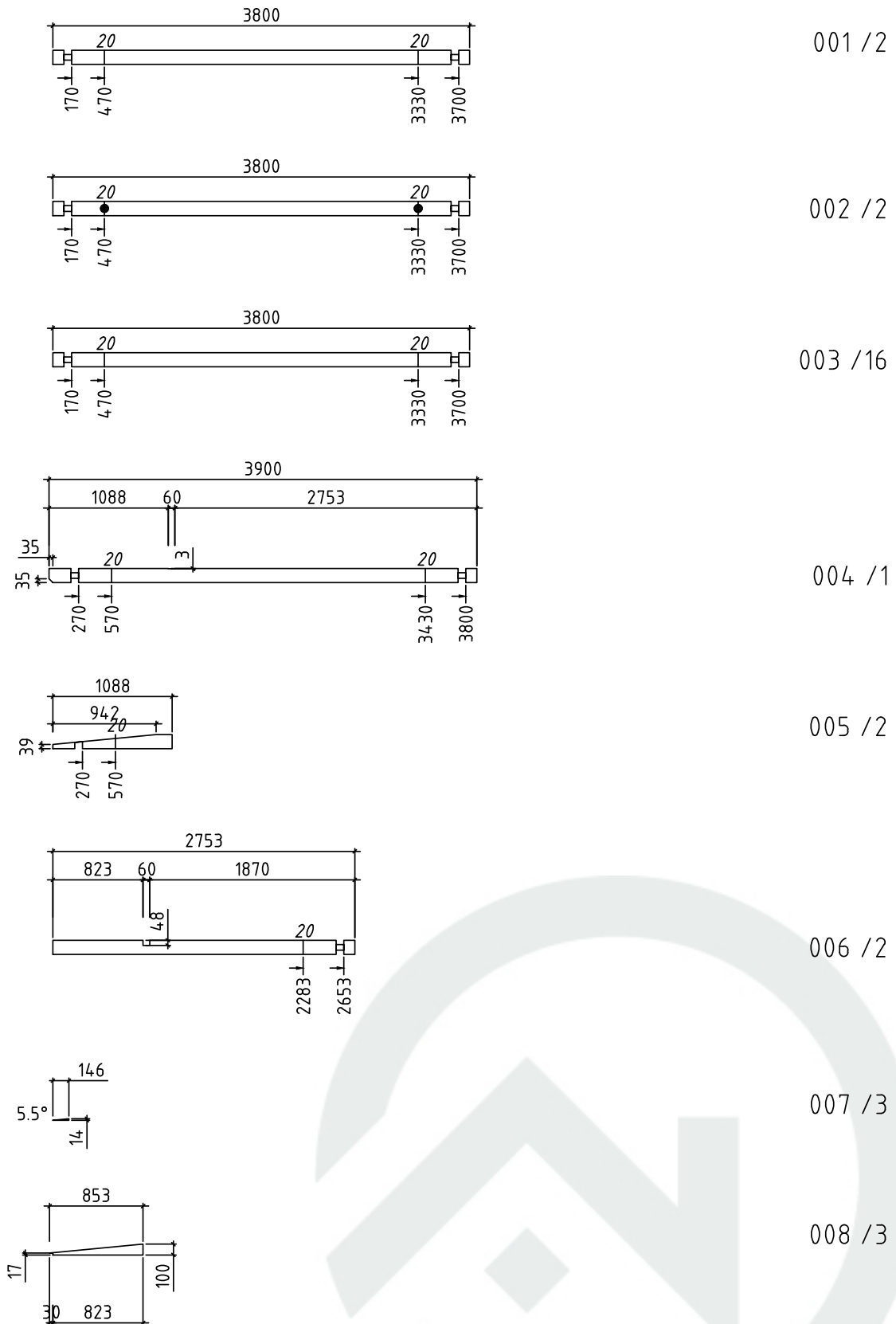

Detailzeichnungen 870870

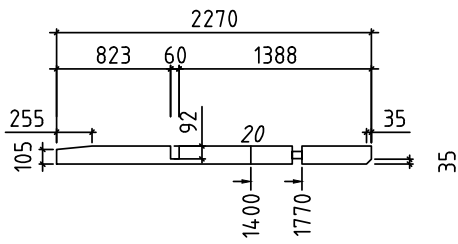

009 / 2

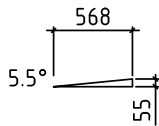

010 / 3

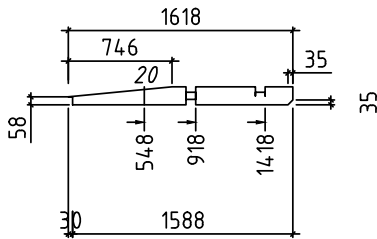

011 / 2

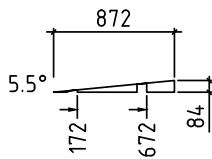

012 / 3

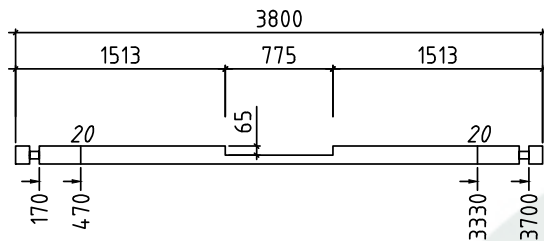

013 / 1

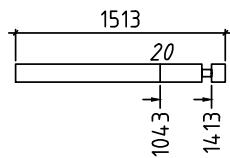

014 / 14

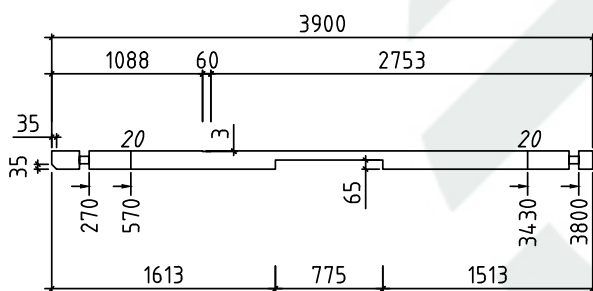

015 / 1

Detailzeichnungen 870870

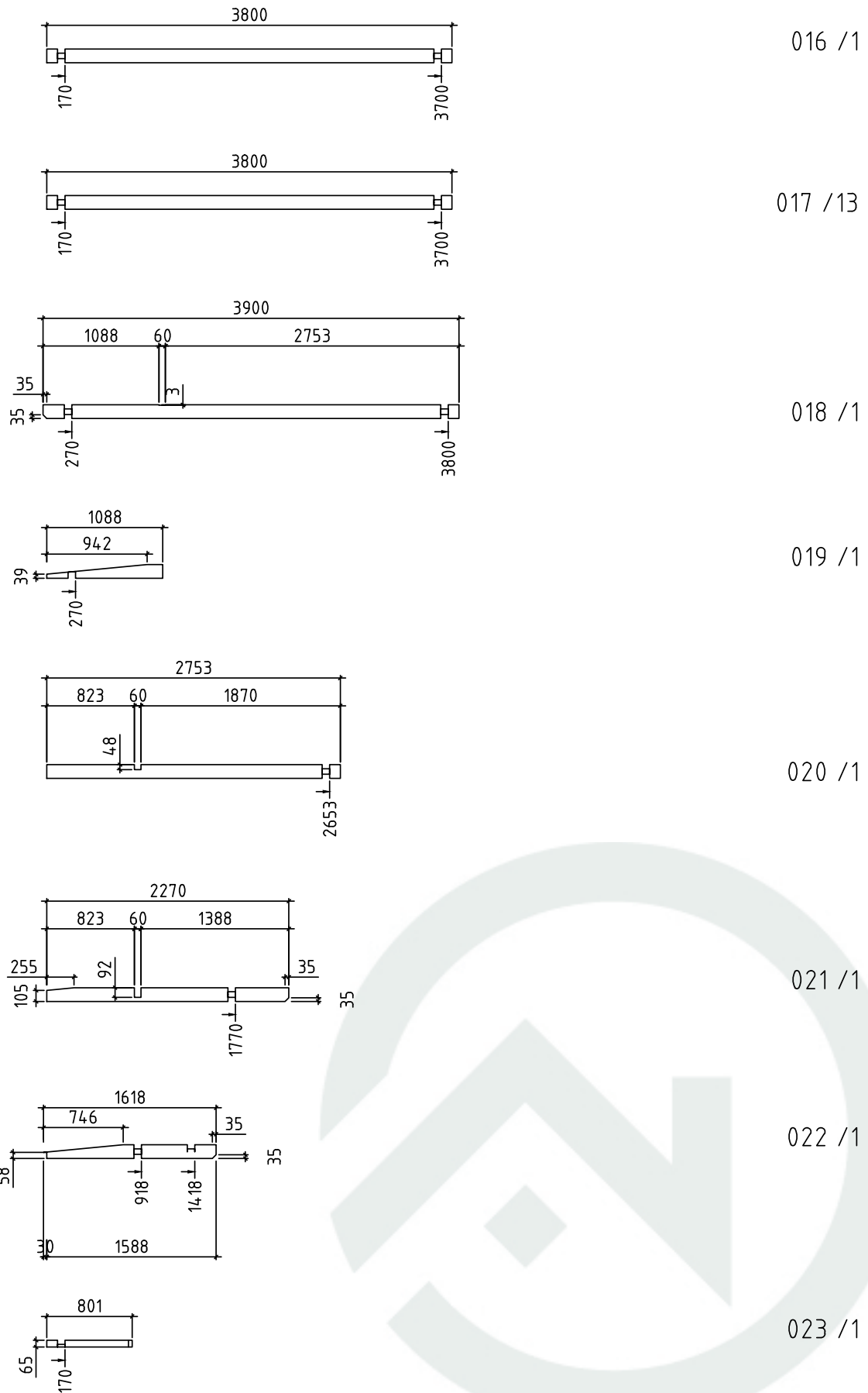

Detailzeichnungen 870870

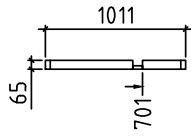

024 /1

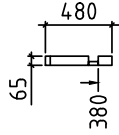

025 /1

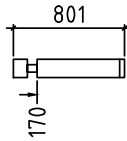

026 /15

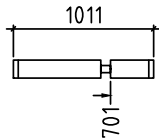

027 /15

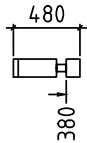

028 /15

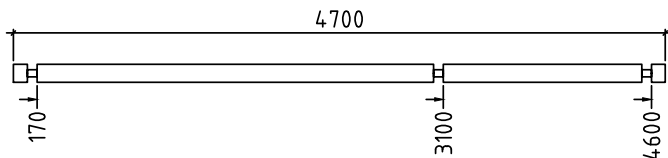

029 /15

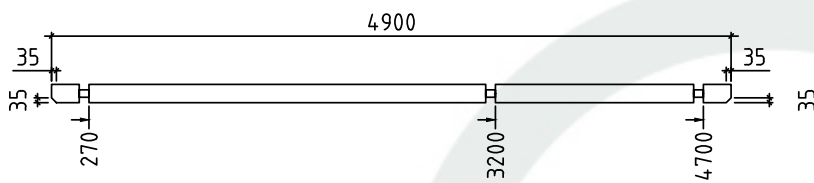

030 /1

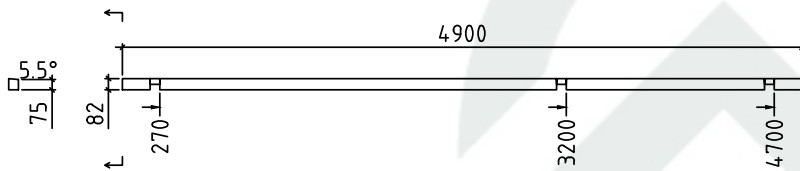

031 /1

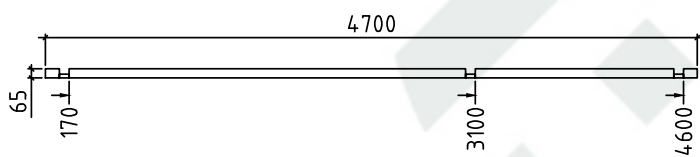

032 /1

Detailzeichnungen 870870

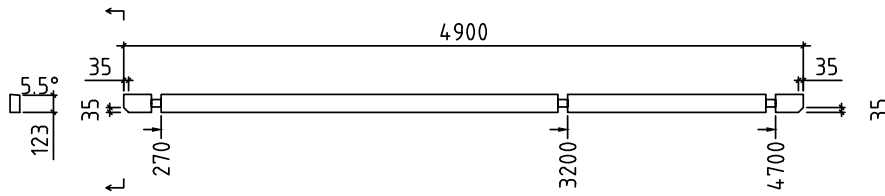

033 / 2

Rahmen-Fundamentholz

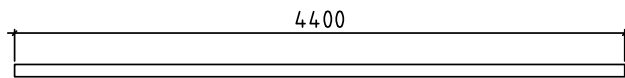

GR1 / 2
45x90

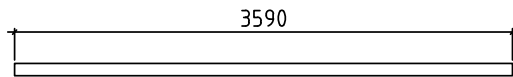

GR2 / 2
45x90

Fundamentholz

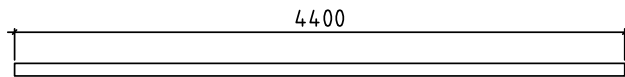

FB1 / 7
45x90

Pfetten

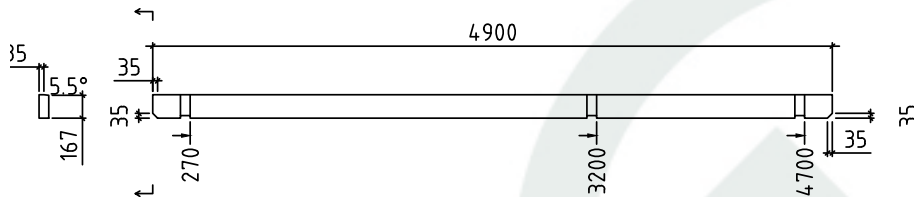

PR1 / 3
70x170(60x150)

Wandplan 1 und 2 870870

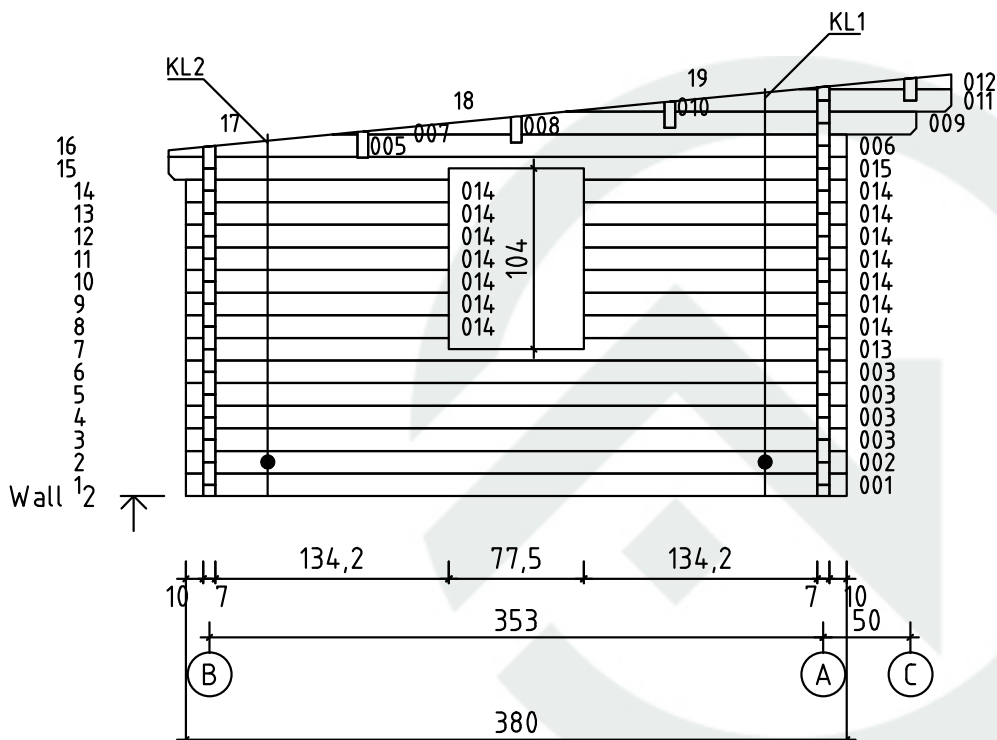
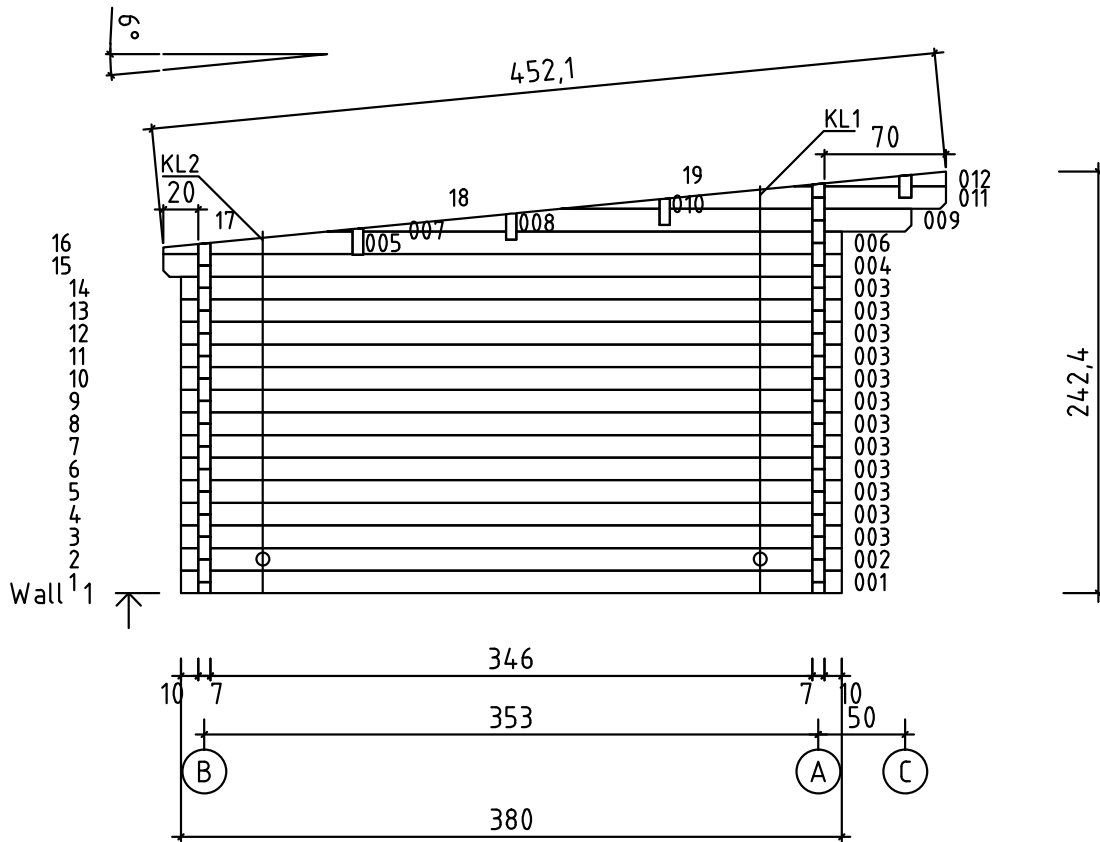

Wandplan 3 870870

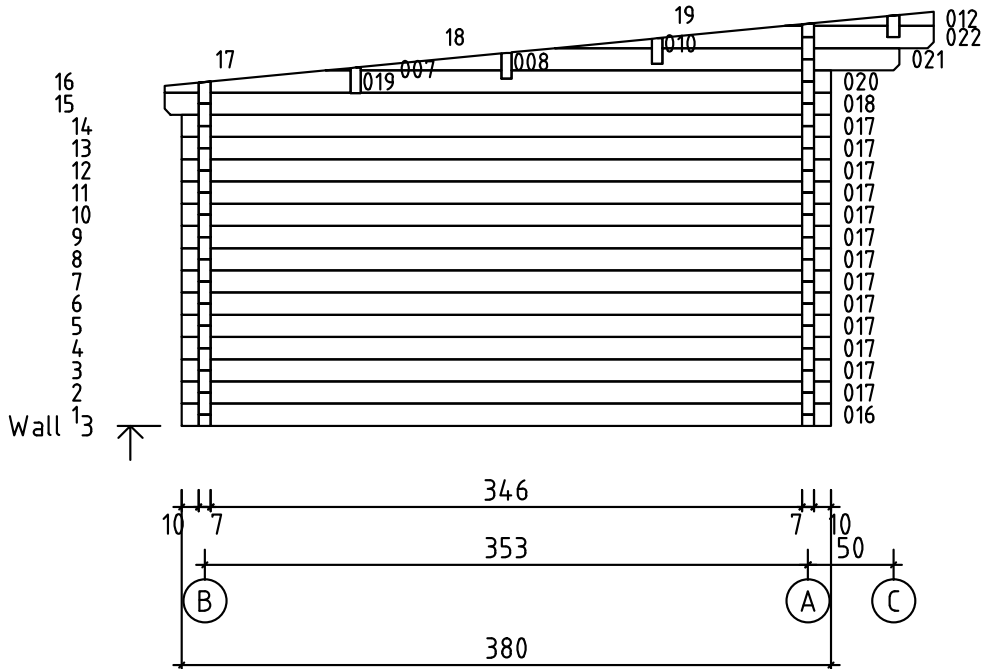

Wandplan A und B 870870

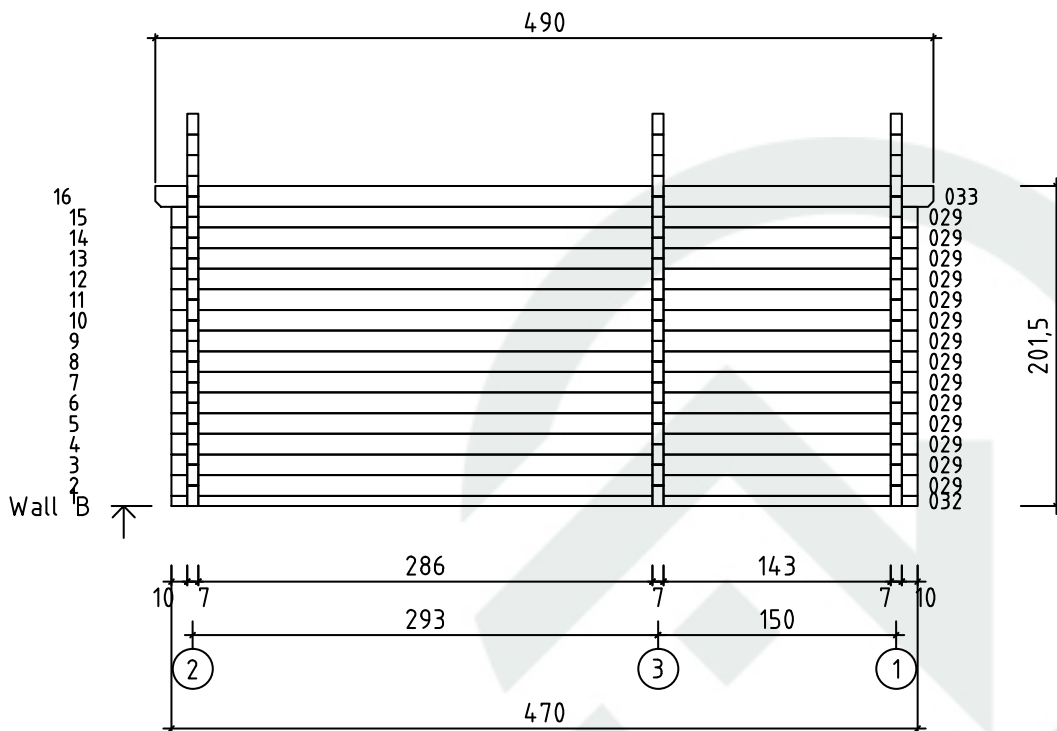
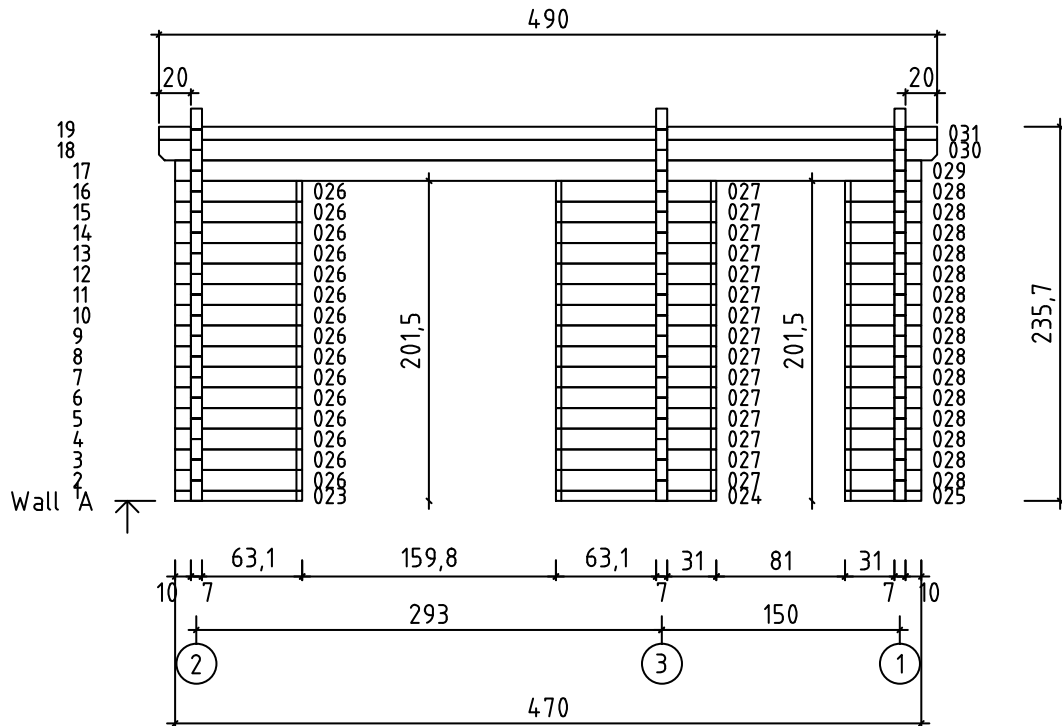

Wandplan C 870870

