

# Technische Daten: Art.-Nr.: 300 130

Wandaußenmaß: 300 x 245 cm

Bohlenstärke: 44 mm



Kontrolliert durch:

Achtung: Alle angegebenen Maße sind ca.-Maße!

# 3D-Ansicht

## 300 130

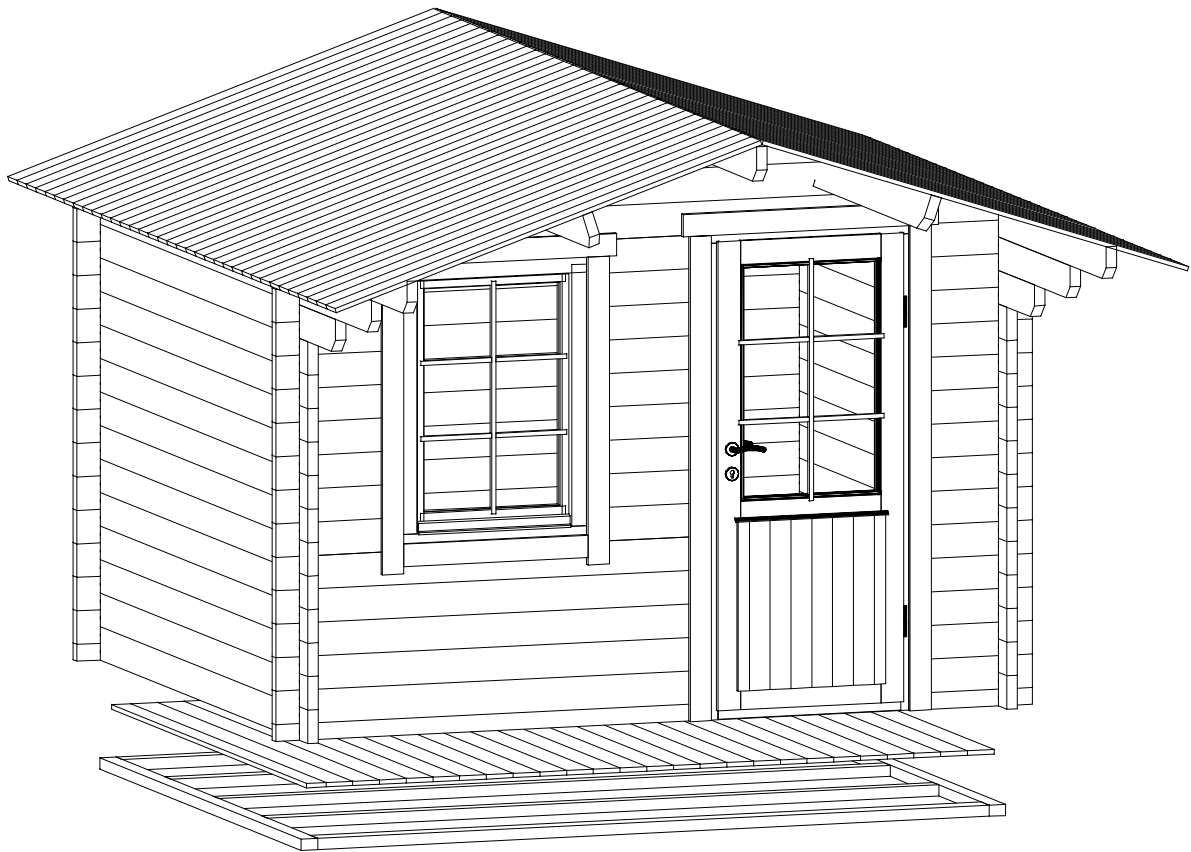

# Grundriss 300 130

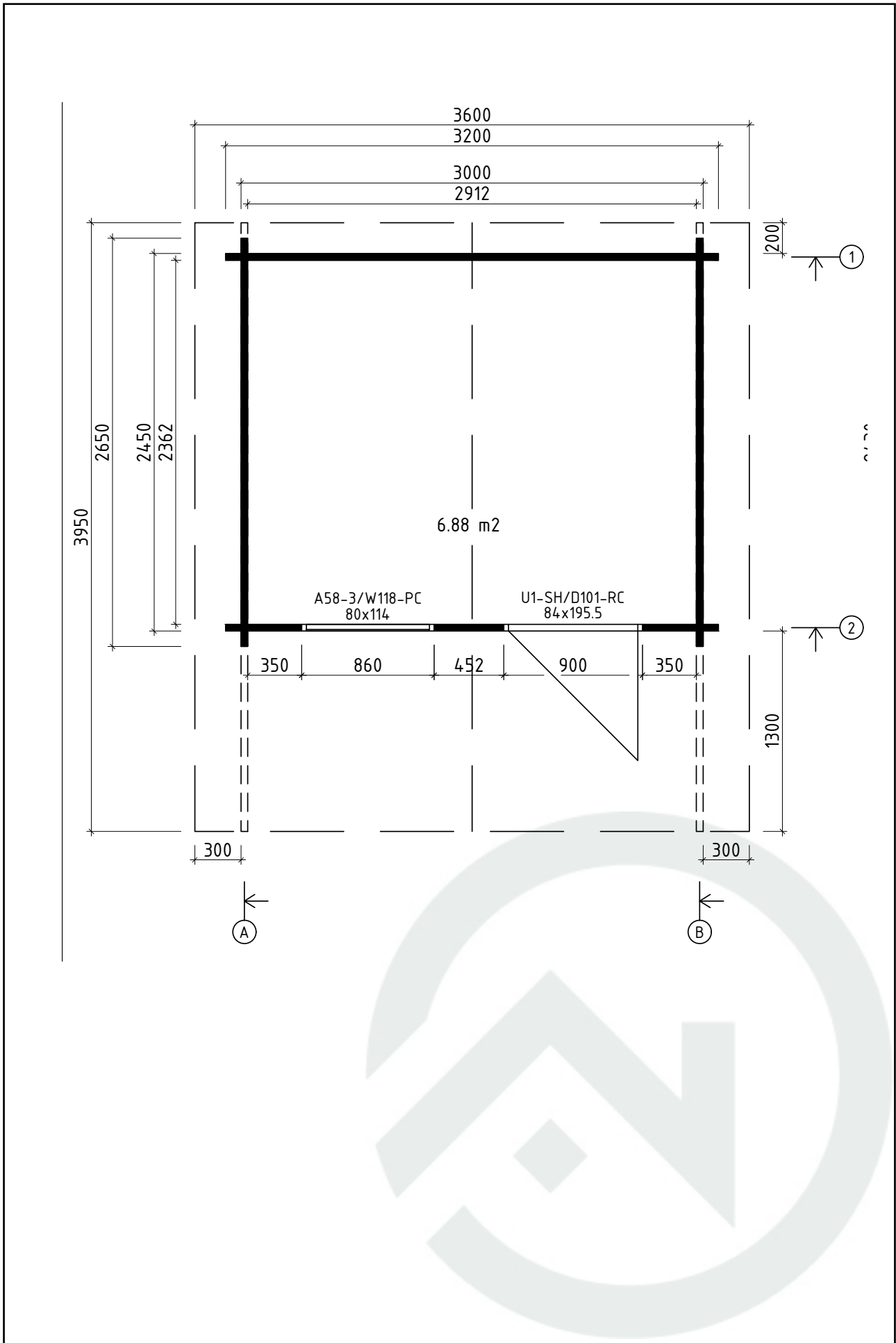





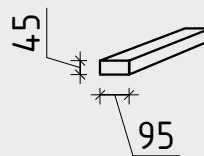
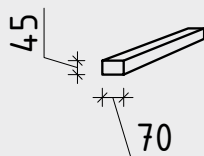
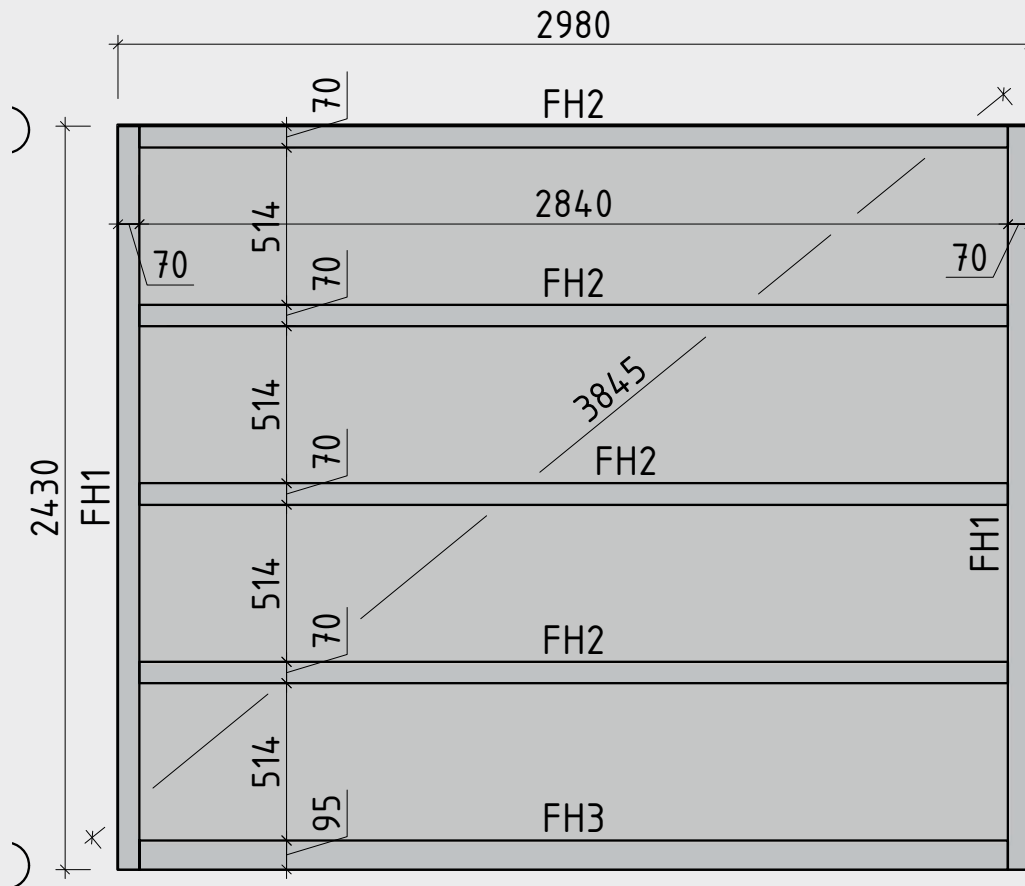





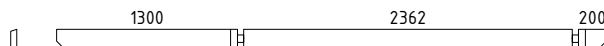

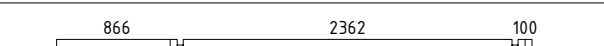
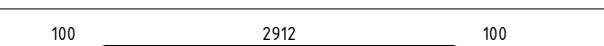

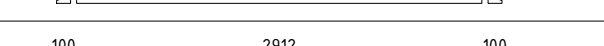
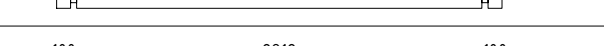

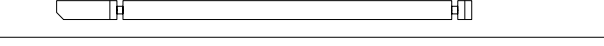

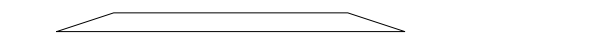

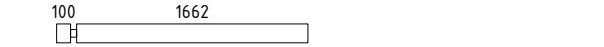
# Lagerholzplan und Fundamentplan 300 130

Wir empfehlen als Fundament für Ihr Gartenhaus eine vollflächig festgegründete, gepflasterte oder betonierte Fläche.  
Wahlweise ist auch ein Punkt- oder Streifenfundament möglich.

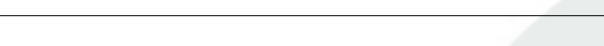



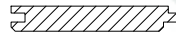
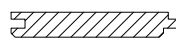













# Teileliste 1

## 300 130

Pos		Stck	Profil (mm)	Länge (mm)
001		1	44x135	3950
002		1	44x135	3950
003		2	44x135	3416
004		1	44x135	3200
005		1	44x135	3200
006		14	44x135	3200
007		1	44x68	3200
008		2	44x135	2983
009		24	44x135	2650
010		2	44x135	2502
011		1	44x68	1806
012		4	44x135	1806
013		1	44x135	1806
014		2	44x135	1683
015		1	44x68	494
016		23	44x135	494
017		9	44x135	452
018		4	44x135	410
FH3	FUNDAMENTHÖLZER (imprägniert) 	1	95x45	2840
FH2	FUNDAMENTHÖLZER (imprägniert) 	4	70x45	2840
FH1	FUNDAMENTHÖLZER (imprägniert) 	2	70x45	2430
PF1	BETTEN 	3	44x145	3950
	DACHBRETTER 	70+1	113x18	1895
	FUSSBODENBRETTER 	26+1	113x18	2357
	FUSSBODENLEISTEN  ✓		18x40	11,0 lfm

# Teileliste 2

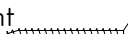
## 300 130

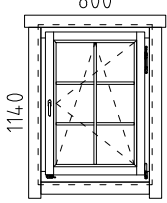
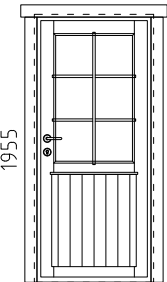
Pos		Stck	Profil (mm)	Länge (mm)
G02-1	GIEBELBRETT 18x120 18,24° 	4	18x120	1975
G06-1	GIEBELDECKLEISTEN 18x58 	4	18x58	1975
T01-1	TRAUFENBRETT 18x95 	2	18x95	3950
T06-1	TRAUFENLEISTEN 18x40 	4	18x40	8,0 lfm
GS	Giebelsegment 	2		
SH	Schlaghölzer 	3		
ML1	Metallstange 	1	D10	14.40
KL1	Gewindestange M8 	4	M8	2000
KL2	Gewindestange M8 	4	M8	55
KV M UT M8	Mutter M8 	8	M8	
KV S EIB M8X25	U-Scheibe M8 Ø25 	8	M8	
KV MU TJ M8	Befestigungsmutter M8 	4	M8	
NG04	NÄGEL 2.5x50 Dachbretter Fussbodenbretter 	680		
SR32	SCHRAUBEN 3.0x30 Fussbodenleisten Traufenleisten 	40		
SR37	SCHRAUBEN 3.5x45 Giebelbretter, Traufenbretter, Giebelsegment Fenster- und Türleisten 	106		
SR57	SCHRAUBEN 5.0x100 Fundamenthölzer 	28		
	<b>FENSTER Q4</b> 800 1140  L1 L2 L3 A58-3/W118-PC L1 18x90 L=1040mm 2x L2 18x90 L=1260mm 4x L3 18x90 L=800mm 2x ✓	1		
	<b>TÜR Q4</b> 840 1955  L1 L2 U1-SH/D101-RC L1 18x90 L=1080mm 2x L2 18x90 L=1955mm 4x ✓ DIN rechts	1		

# Wandplan 1 und 2

## 300 130

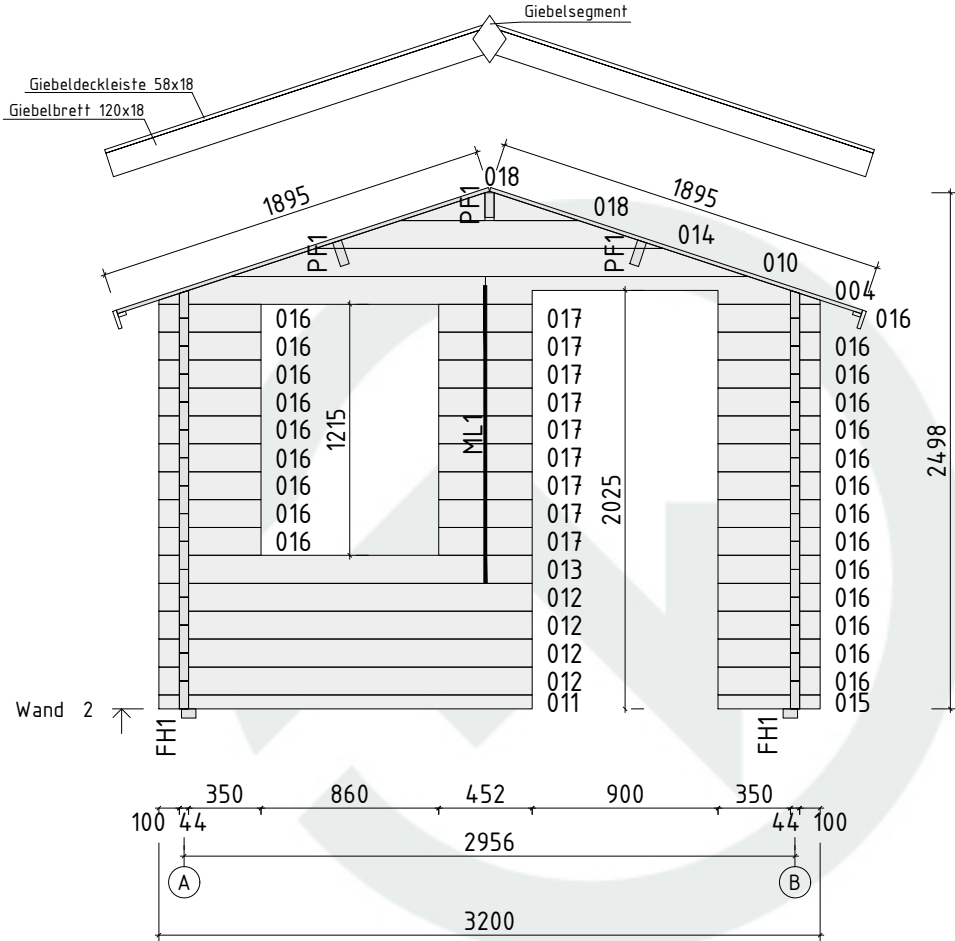
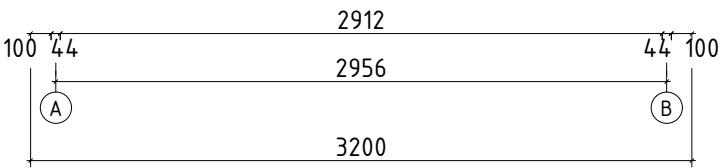
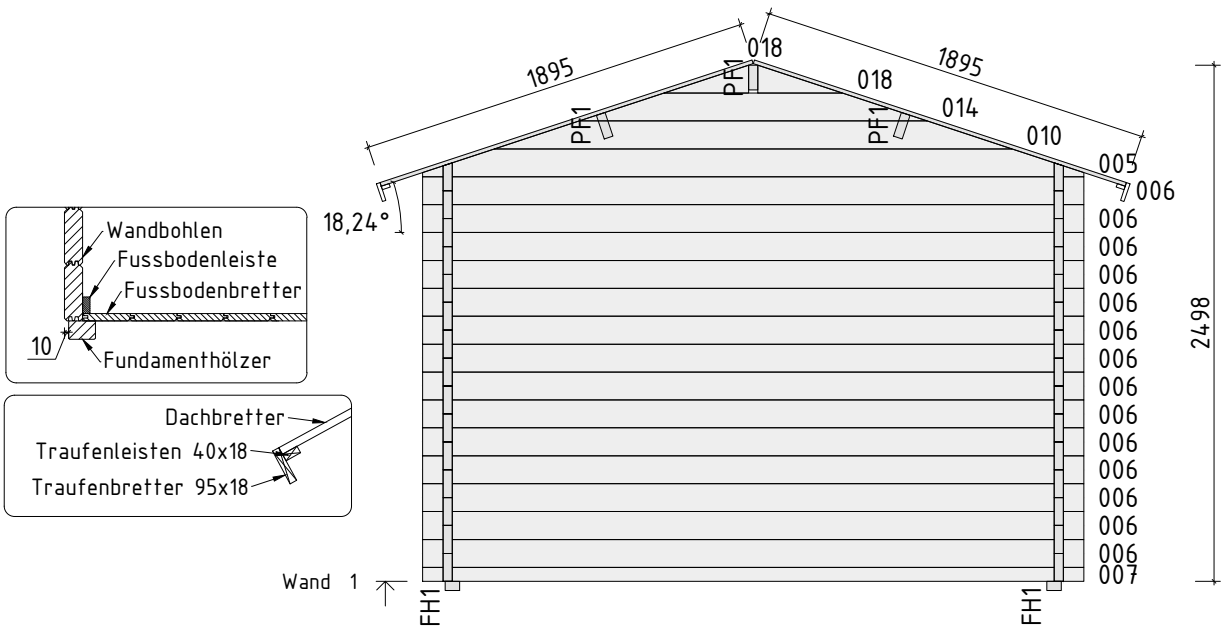

# Wandplan A und B 300 130

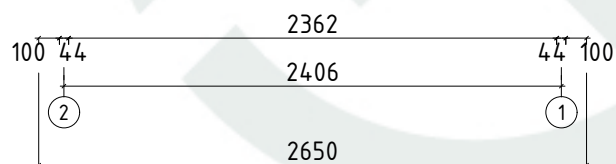
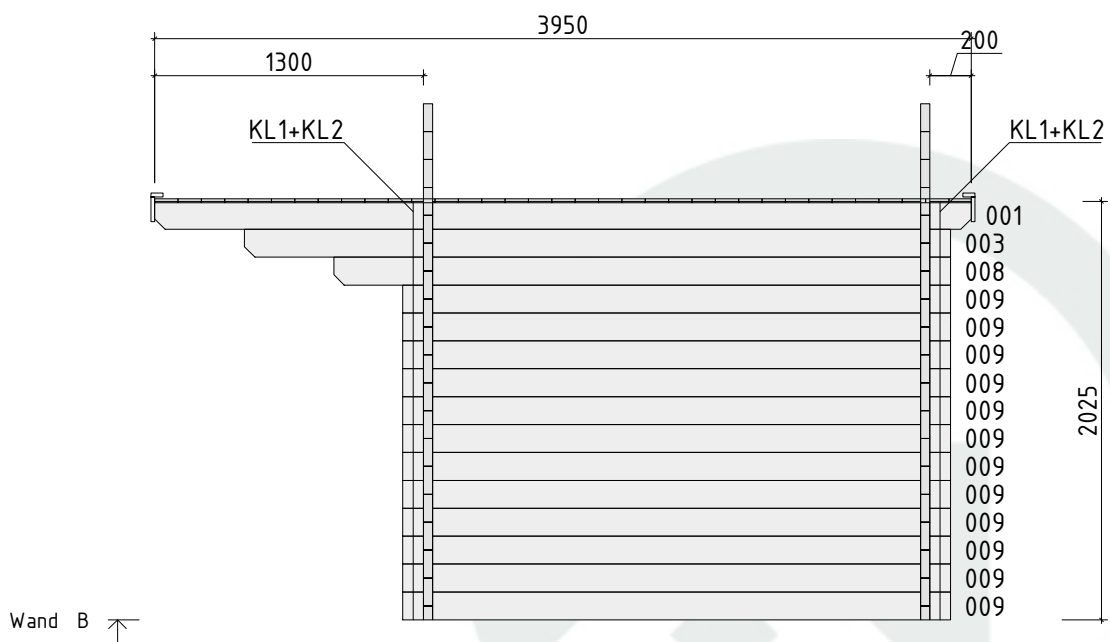
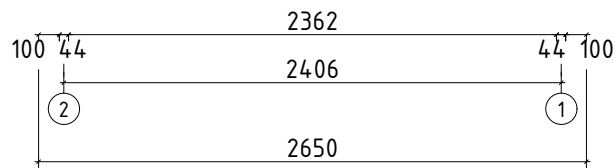
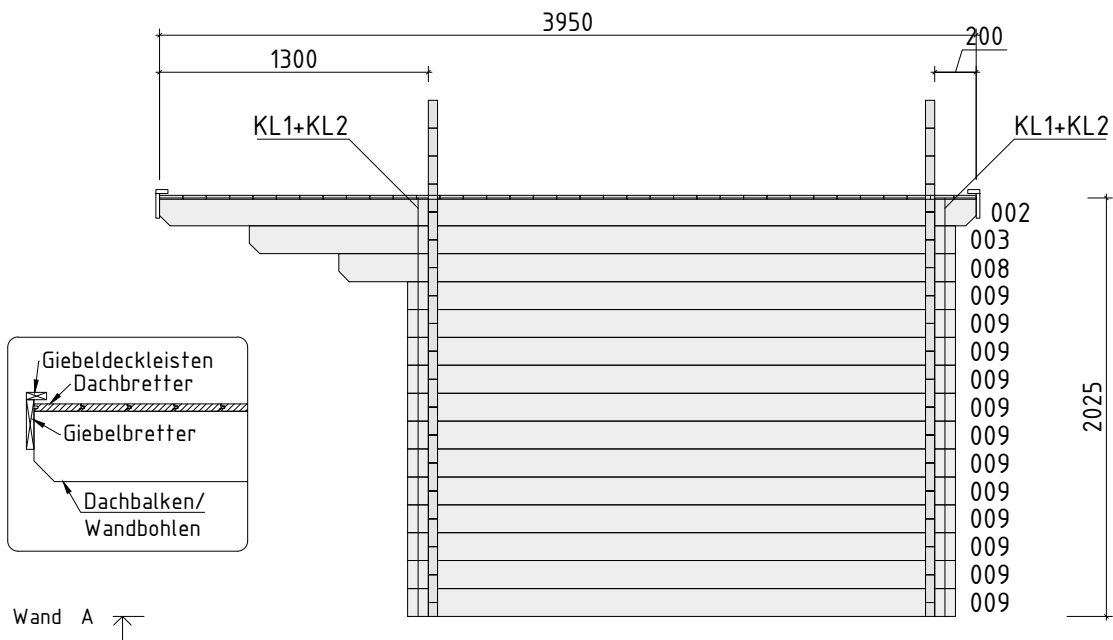



# Details

## 300 130

Akna tüüp / Fenster typ / Window type - A68  
(GH+ / SH)

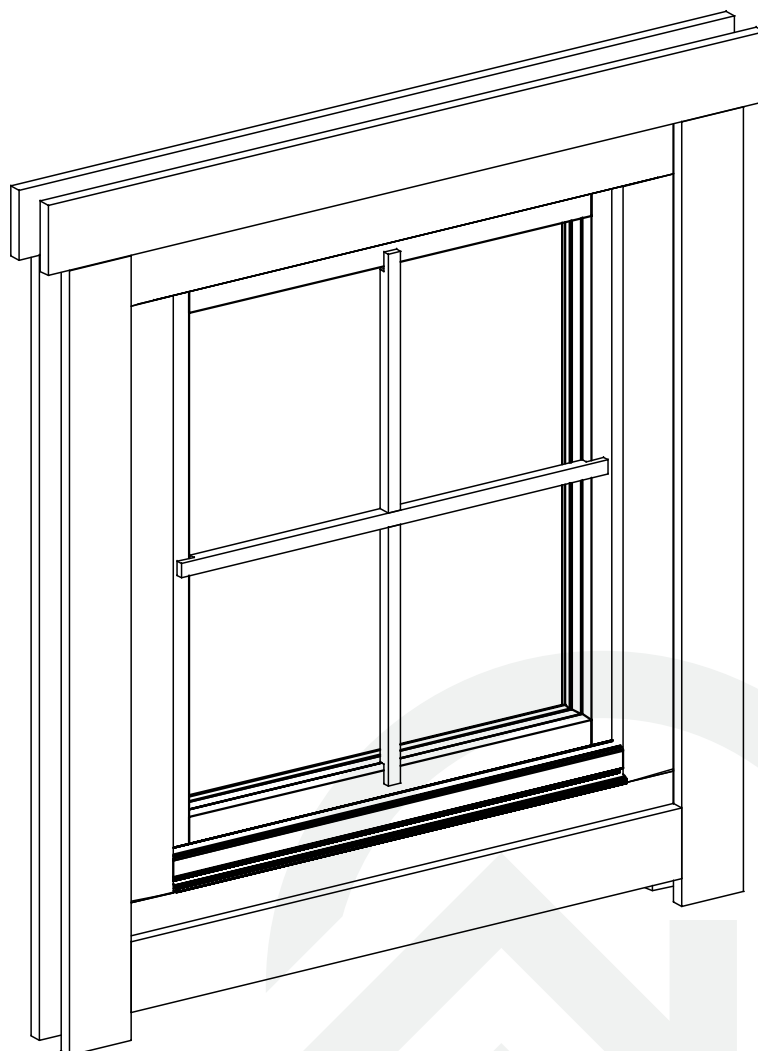

# Details 300 130

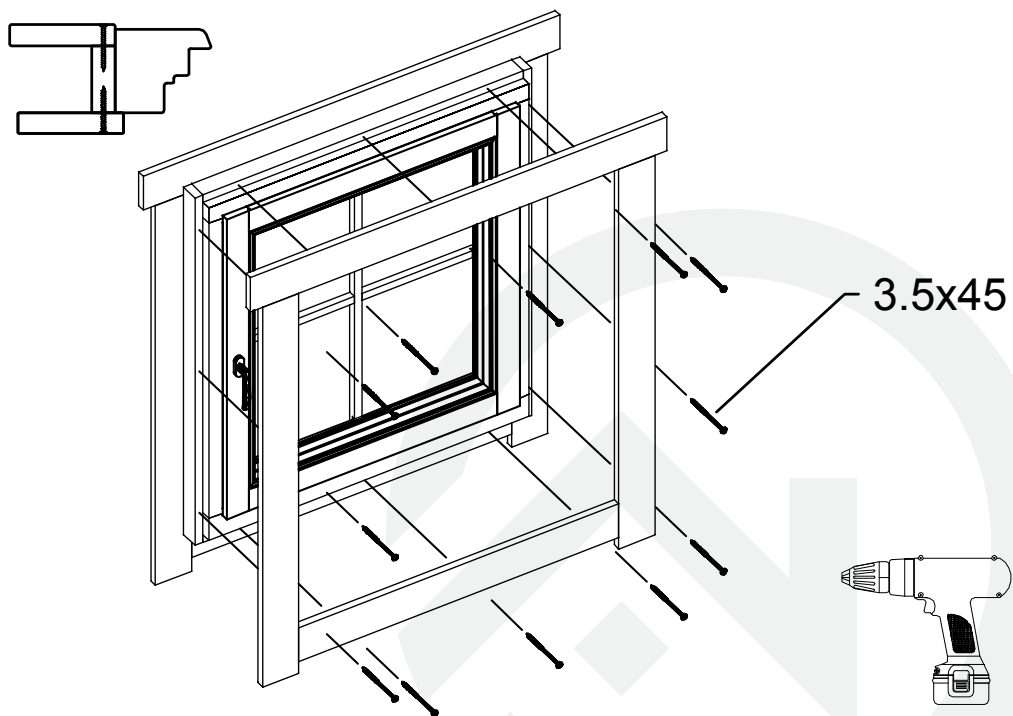
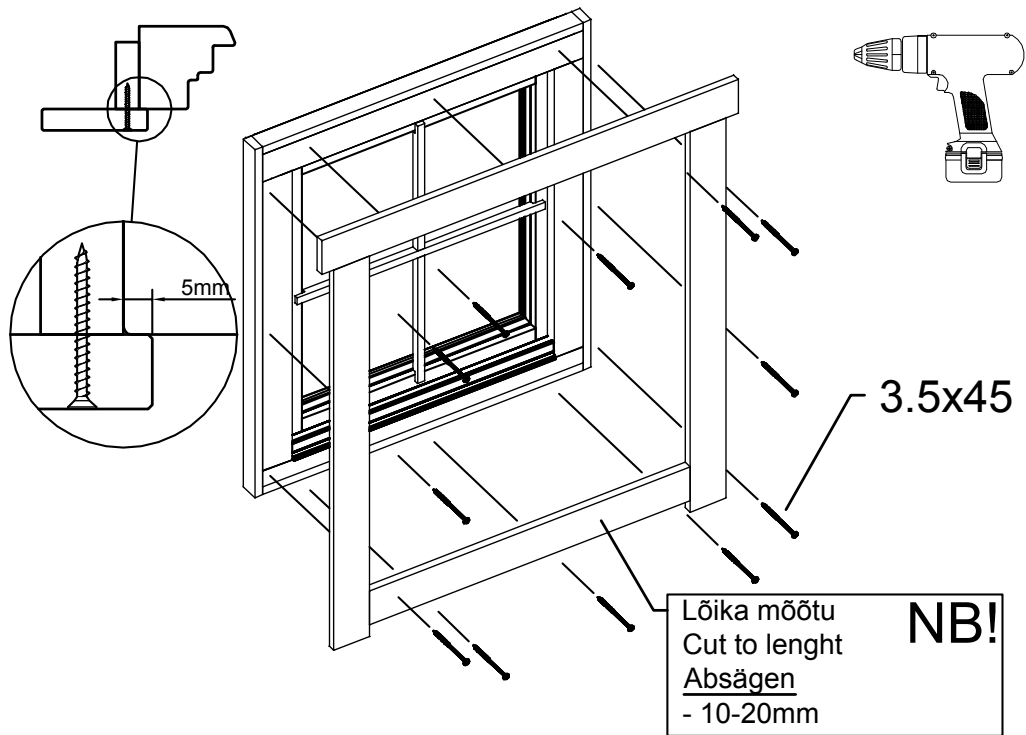

# Details

## 300 130

Ukse montaaž / Tür montage / Door assembly  
(GH+ / SH)

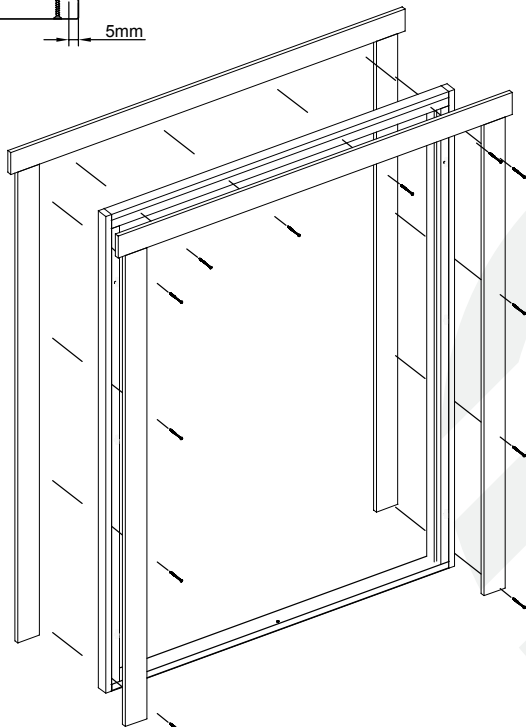
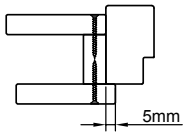
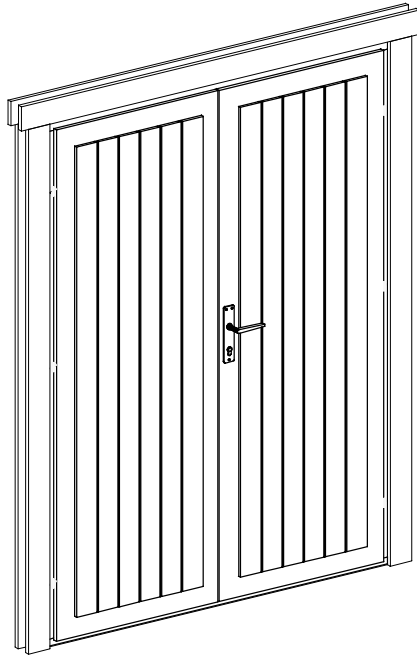

3.5x45

4.5x90

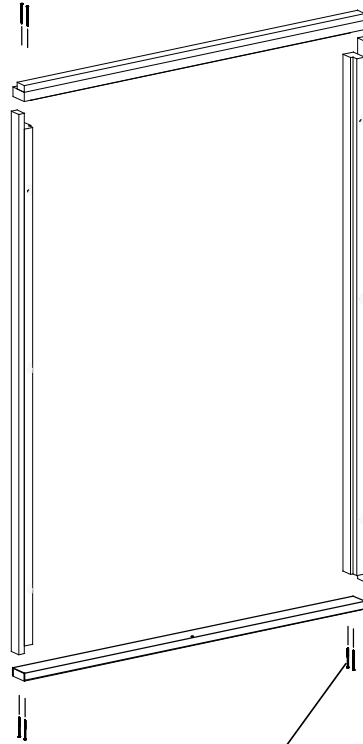

4.5x90

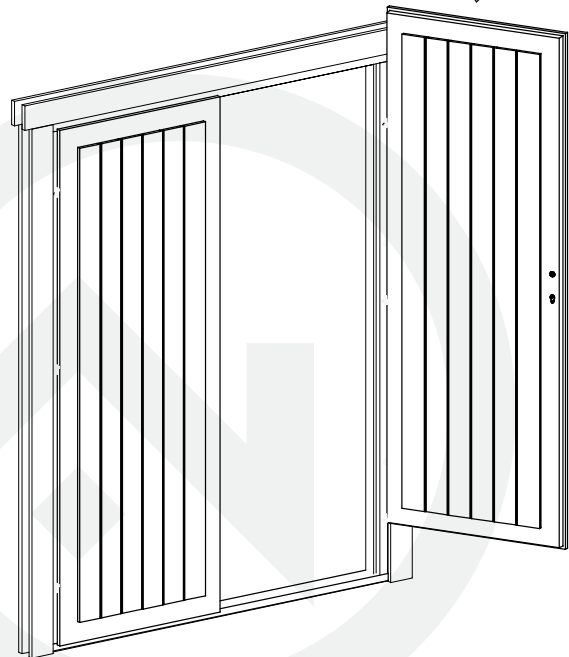
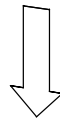

# Details 300 130

